

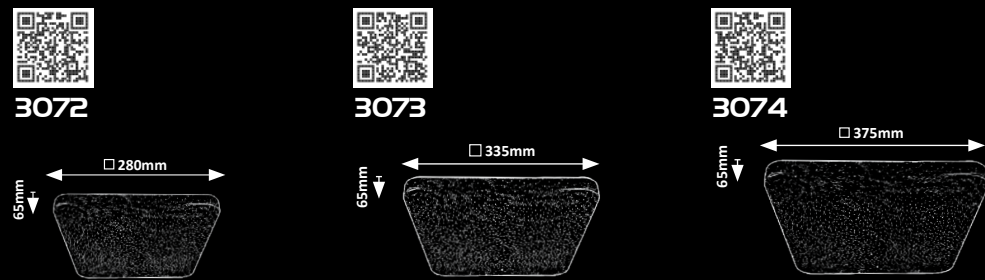

LUCAS



3072 (MP)

LED / 12W
(780lm, 4000K) incl.
IP20 • 19907
white



3073 (MP)

LED / 18W
(1170lm, 4000K) incl.
IP20 • 19908
white



3074 (MP)

LED / 24W
(1560lm, 4000K) incl.
IP20 • 19909
white



LUCAS

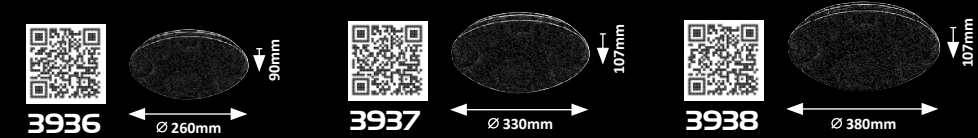
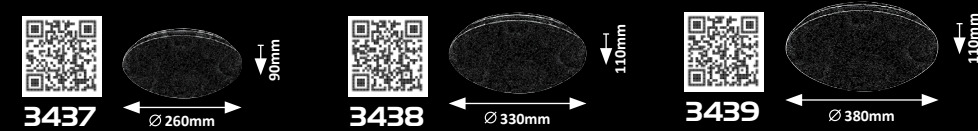

3437 (MP)

LED / 12W
(780lm, 4000K) incl.
IP44 • 19714
white



3438 (MP)

LED / 18W
(1170lm, 4000K) incl.
IP44 • 19715
white



3439 (MP)

LED / 24W
(1560lm, 4000K) incl.
IP44 • 19716
white



3936 (MP)

LED / 12W
(700lm, 4000K) incl.
IP20 • 19754
white



3937 (MP)

LED / 18W
(1140lm, 4000K) incl.
IP20 • 19755
white



3938 (MP)

LED / 24W
(1370lm, 4000K) incl.
IP20 • 19756
white

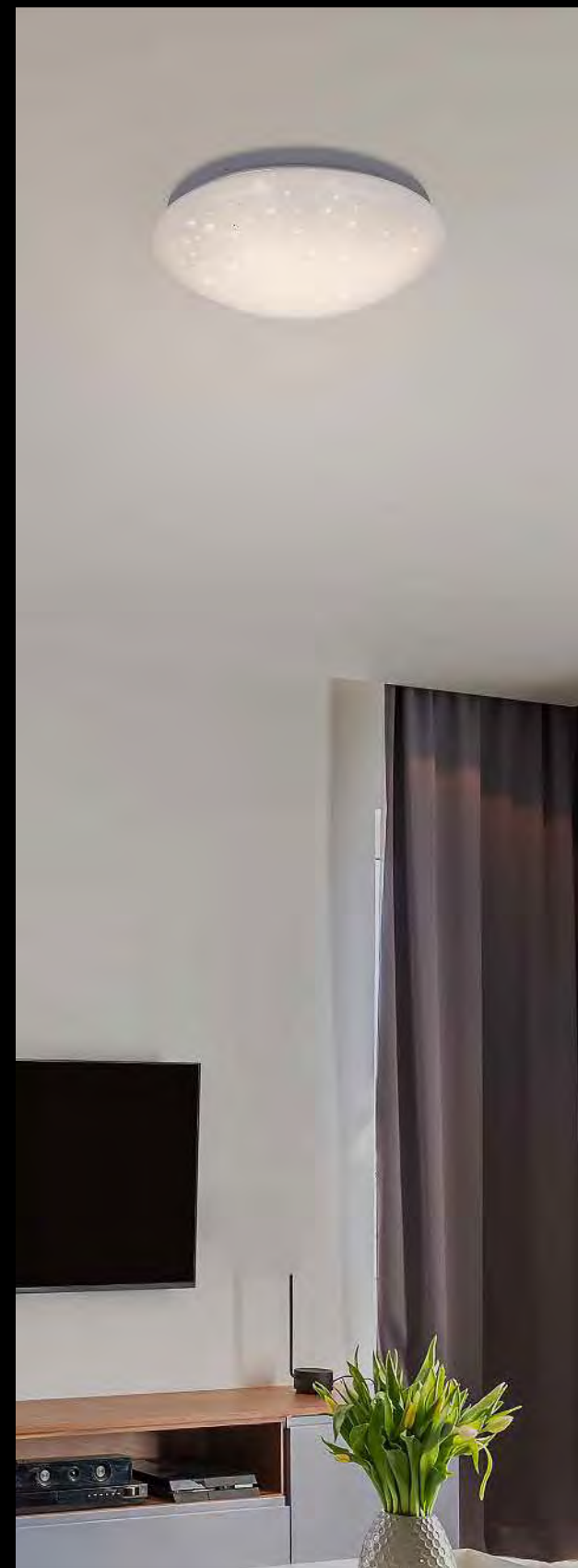



LUCAS

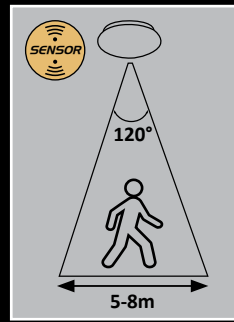

3418

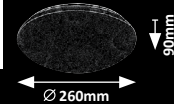

3419

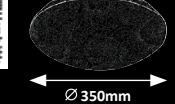

3420

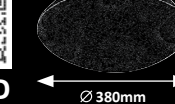

3434

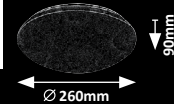

3435

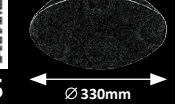

3436

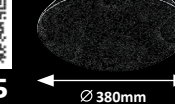

TREVOR



3008

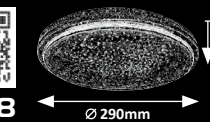

3009

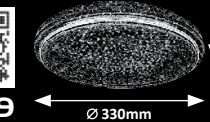

3010

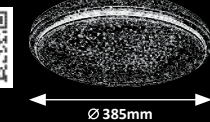

3418 (M P)

LED / 12W
(780lm, 4000K) incl.
IP44 • 5-8m, 120°
19714 • white



3419 (M P)

LED / 18W
(1170lm, 4000K) incl.
IP44 • 5-8m, 120°
19715 • white



3420 (M P)

LED / 24W
(1560lm, 4000K) incl.
IP44 • 5-8m, 120°
19716 • white



3434 (M P)

LED / 12W
(780lm, 4000K) incl.
IP20 • 19711
white



3435 (M P)

LED / 18W
(1170lm, 4000K) incl.
IP20 • 19712
white



3436 (M P)

LED / 24W
(1560lm, 4000K) incl.
IP20 • 19713
white



3008 (M A)

LED / 12W
(780lm, 3000K) incl.
IP20 • 19903
white



3009 (M A)

LED / 18W
(1170lm, 3000K) incl.
IP20 • 19904
white



3010 (M A)

LED / 24W
(1560lm, 3000K) incl.
IP20 • 19905
white





ROB

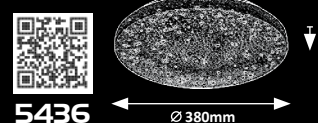
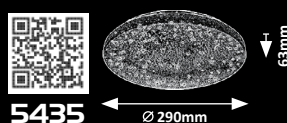
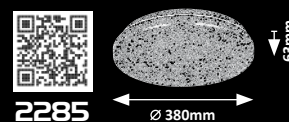
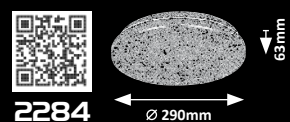

2284 (M P)

LED / 20W
(1400lm, 4000K) incl.
IP20 • 19676
white



2285 (M P)

LED / 32W
(2600lm, 4000K) incl.
IP20 • 19677
white



5435 (M P)

LED / 20W
(1400lm, 4000K) incl.
IP20 • 19826
white



5436 (M P)

LED / 32W
(2600lm, 4000K) incl.
IP20 • 19827
white



ROB

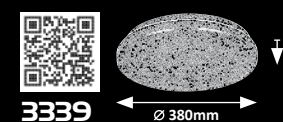
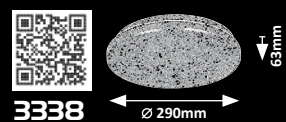
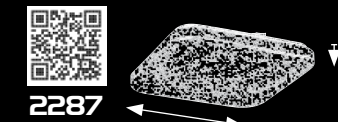
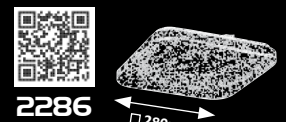

2286 (M P)

LED / 20W
(1400lm, 4000K) incl.
IP20 • 19678
white



2287 (M P)

LED / 32W
(2600lm, 4000K) incl.
IP20 • 19679
white



3338 (M P)

LED / 20W
(1400lm, 3000K) incl.
IP20 • 19914
white



3339 (M P)

LED / 32W
(2600lm, 3000K) incl.
IP20 • 19915
white



3340 (M P)

LED / 20W
(1400lm, 3000K) incl.
IP20 • 19916
white



3344 (M P)

LED / 32W
(2600lm, 3000K) incl.
IP20 • 19917
white

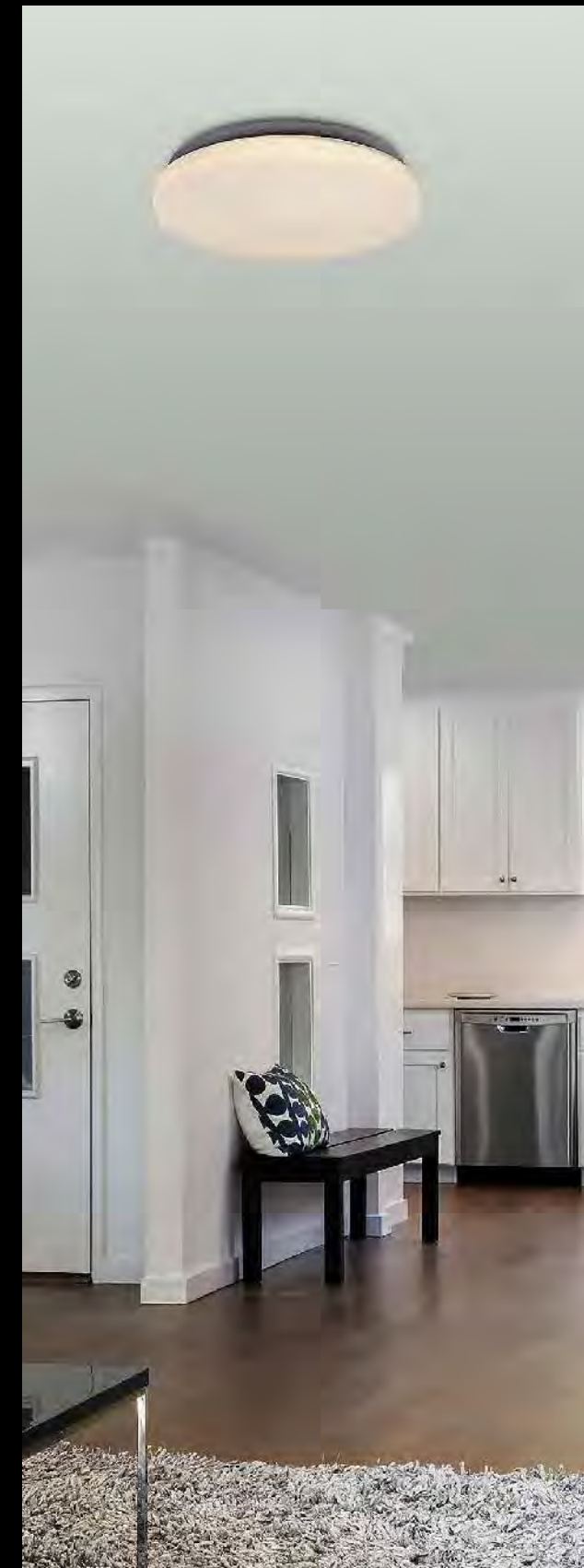



DAMEK

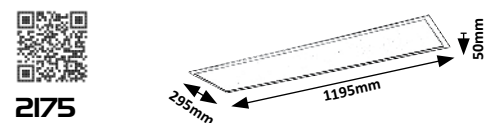
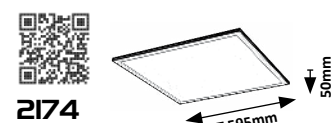
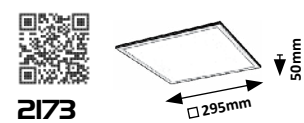

TALEB

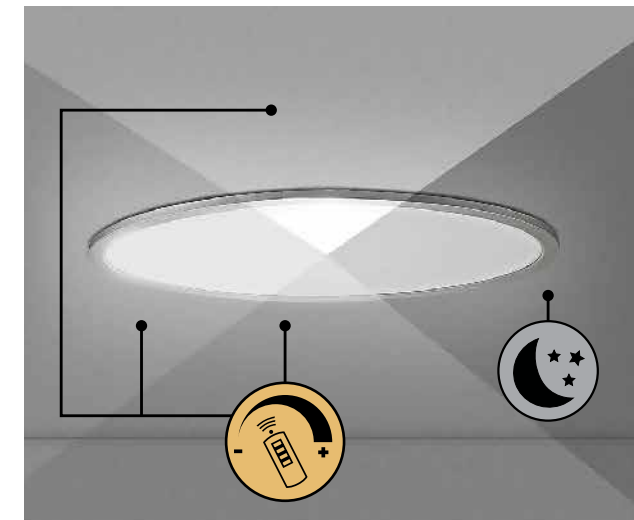
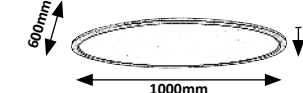
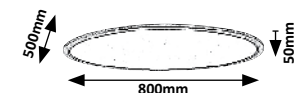
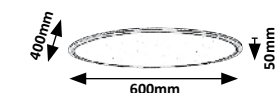

EN The lamp's memory function retains preset settings and reboots accordingly.

HU A lámpa memória funkciója megőrzi az utolsó beállításokat és ennek megfelelően indul újra.

DE Die Speicherfunktion der Lampe behält die voreingestellten Einstellungen bei und startet entsprechend neu.

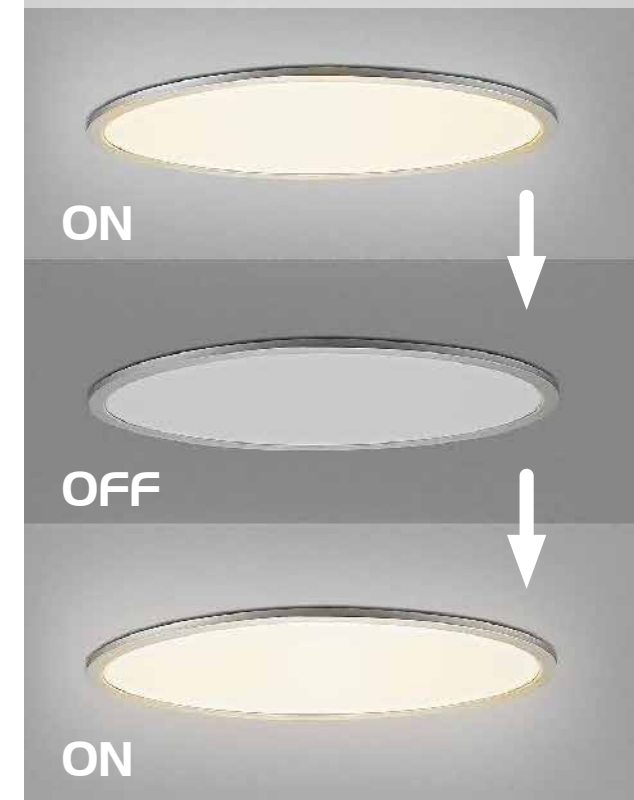

2173 (M) (P)

LED / 12W
(1260lm, 4000K) incl.
IP20
white



5 998250 321738

2174 (M) (P)

LED / 40W
(4200lm, 4000K) incl.
IP20
white



5 998250 321745

2175 (M) (P)

LED / 40W
(4200lm, 4000K) incl.
IP20
white



5 998250 321752

2191 (M) (P)

LED / 40W
(3200lm, 3000K-6000K) incl.
IP20 • 527
silver/white



5 998250 321912

2192 (M) (P)

LED / 50W
(4000lm, 3000K-6000K) incl.
IP20 • 527
silver/white



5 998250 321929

2193 (M) (P)

LED / 60W
(4800lm, 3000K-6000K) incl.
IP20 • 527
silver/white



5 998250 321936



LORNA

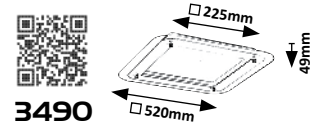
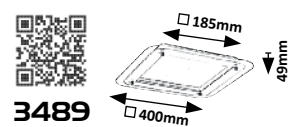
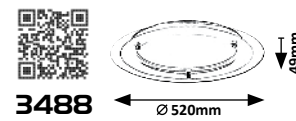
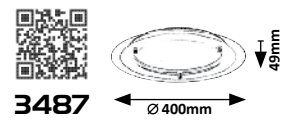

PAVEL

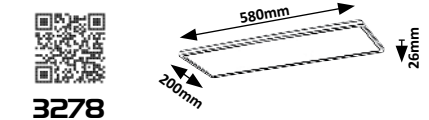
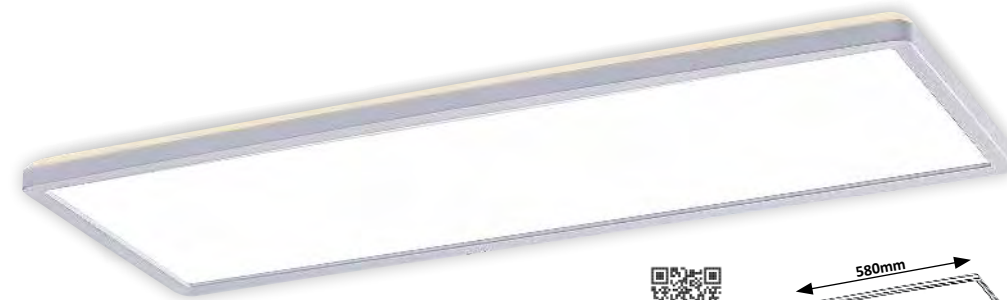
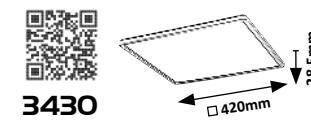
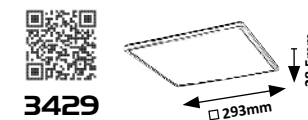
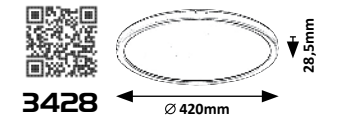
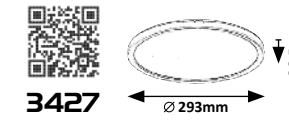

3487 G P

LED / 18W
(1700lm, 4000K) incl.
IP20 • 19798
white



5 998250 334875

3488 G P

LED / 22W
(2200lm, 4000K) incl.
IP20 • 19799
white



5 998250 334882

3489 G P

LED / 18W
(1700lm, 4000K) incl.
IP20 • 19800
white



5 998250 334899

3490 G P

LED / 22W
(2200lm, 4000K) incl.
IP20 • 19801
white



5 998250 334905

3427 P

LED / 18W
(1700lm, 4000K) incl.
IP20
white



5 998250 334271

3428 P

LED / 22W
(2200lm, 4000K) incl.
IP20
white



5 998250 334288

3429 P

LED / 18W
(1700lm, 4000K) incl.
IP20
white



5 998250 334295

3430 P

LED / 22W
(2200lm, 4000K) incl.
IP20
white



5 998250 334301

3278 P

LED / 22W
(2200lm, 4000K) incl.
IP20
white



5 998250 332789



ALMOND

NEW



6907



6908



6909

6907 **MP**

LED / 12W
 (1260lm, 4000K) incl.
 IP20
 beech/white



5 998250 369075

6908 **MP**

LED / 40W
 (4200lm, 4000K) incl.
 IP20
 beech/white



5 998250 369082

6909 **MP**

LED / 40W
 (4200lm, 4000K) incl.
 IP20
 beech/white



5 998250 369099

TAMINO

NEW



2427

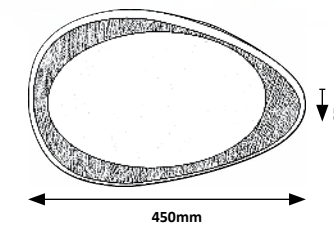

2427 **MA**

LED / 24W
 (1200lm, 4000K) incl.
 IP20 • 19967
 beech/white



5 998250 324272



3500

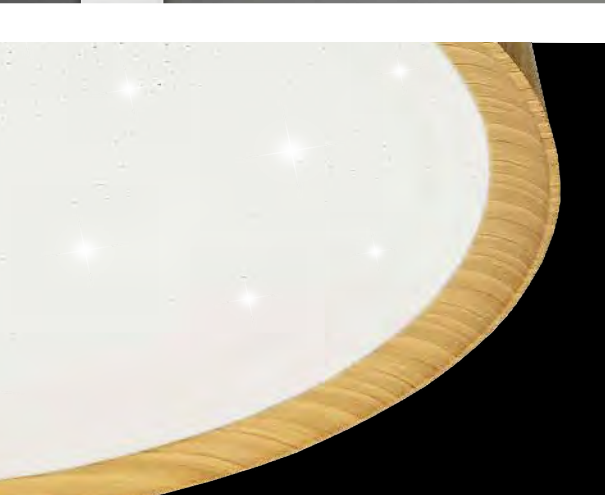
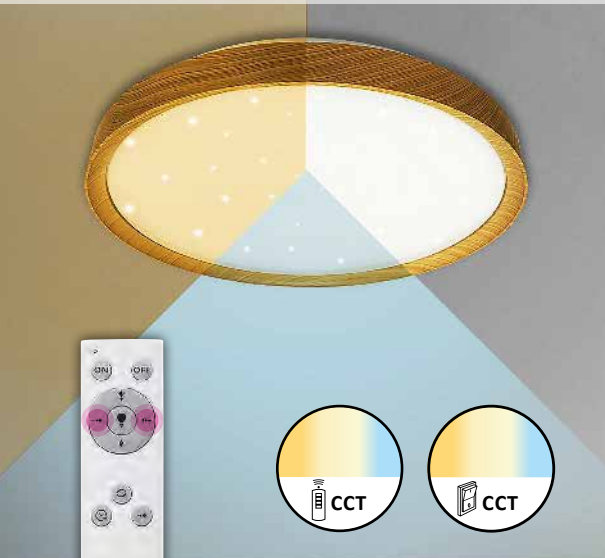

SHERWOOD



3500

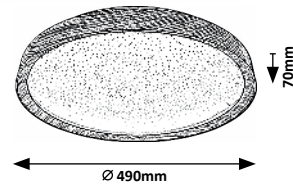

LEANA



6579

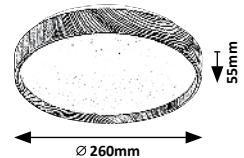

6580

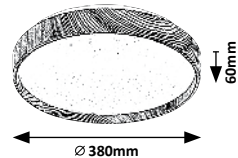

MAPLE



3527

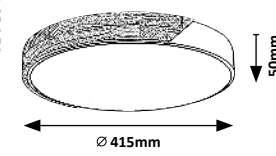

3528

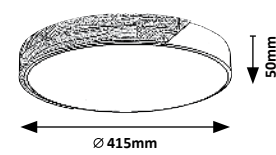

3500 M P

LED / 50W
(4000lm, 3000K-6500K) incl.
IP20 • 19990 • 502
beech/white



5 998250 335001

6579 M P

LED / 12W
(700lm, 3000K) incl.
IP20 • 19993
beech/white



5 998250 365794

6580 M P

LED / 24W
(1300lm, 3000K) incl.
IP20 • 19994
beech/white



5 998250 365800

3527 M W P

LED / 24W
(1760lm, 3000K) incl.
IP20 • 19947
matte white/beech



5 998250 335278

3528 M W P

LED / 24W
(1890lm, 4000K) incl.
IP20 • 19947
matte black/beech



5 998250 335285





ASHTON

5 YEARS GUARANTEE LED built-in G A G NEW



6589

WARM White

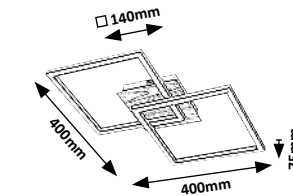

6590

NATURAL White

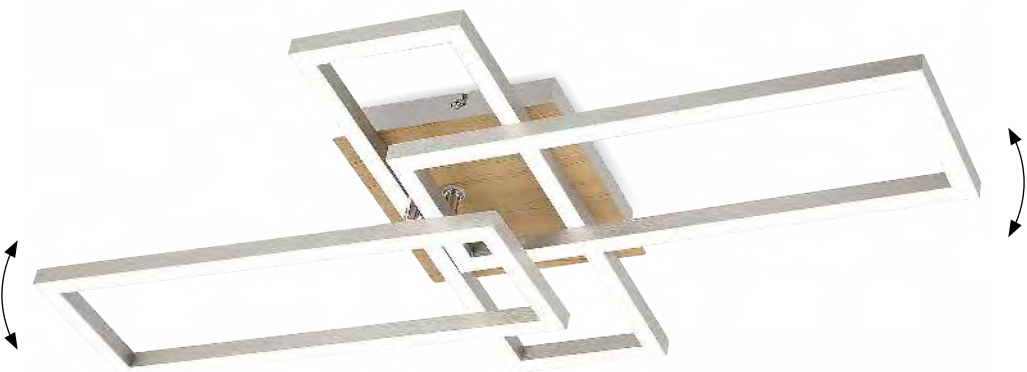
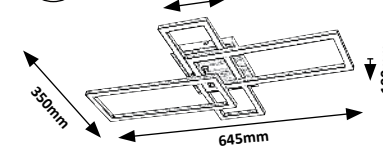

6814

WARM White

100%

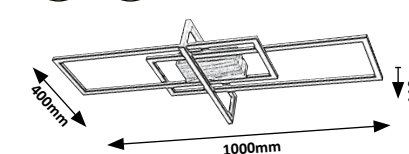

6589 MP

LED / 24W
(1600lm, 3000K) incl.
IP20
beech/matte black/white



5 998250 365893

6590 MP

LED / 24W
(1870lm, 4000K) incl.
IP20
beech/satin chrome/white



5 998250 365909

6814 MP

LED / 35W
(1800lm, 3000K) incl.
IP20
beech/matte black/white



5 998250 368146



07

**WALL AND
CEILING LAMPS,
PENDANTS**

**FALI- ÉS MENNYEZETLÁMPÁK,
FÜGGESZTÉKEK**

**WAND- UND DECKENLEUCHTEN,
PENDELLEUCHTEN**



HOLDEN

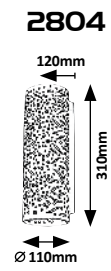
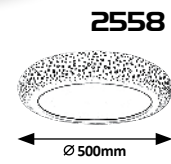
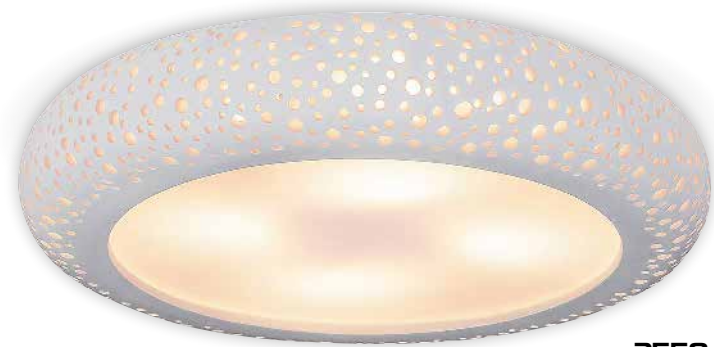

STRIPE

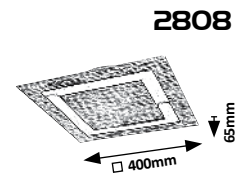
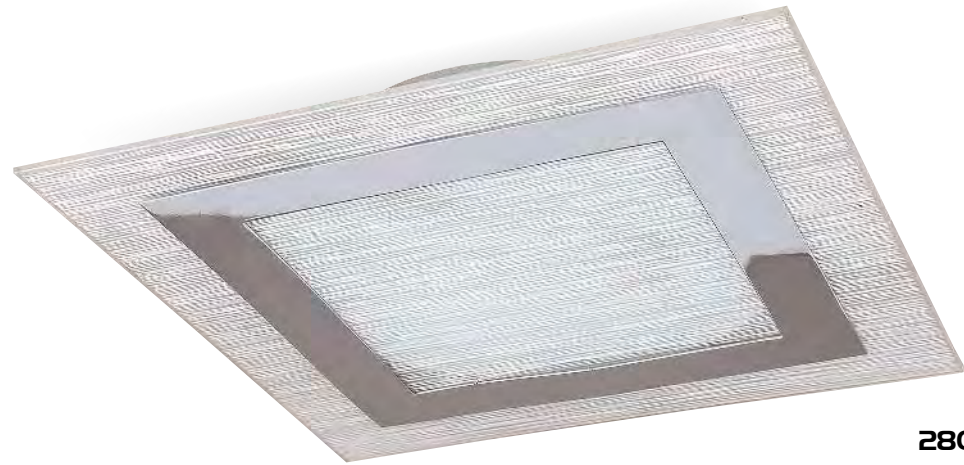

2558 **M PL**
 ☒ E27 / 4x max. 25W
 IP20 • 19580
 white



2804 **M PL**
 ☒ E14 / 2x max. 40W
 IP20 • 19533
 white



2808 **M G**
 ☒ E27 / 2x max. 60W
 IP20 • 19203
 chrome/white



ART GOLD

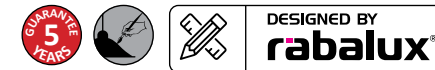

1940

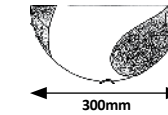

1941

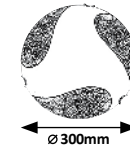

1942



1940 **M G**
 ☒ E27 / 1x max. 60W
 IP20 • 1390
 white/gold



1941 **M G**
 ☒ E27 / 1x max. 60W
 IP20 • 1391
 white/gold



1942 **M G**
 ☒ E27 / 2x max. 60W
 IP20 • 1392
 white/gold





LARETTA



3712

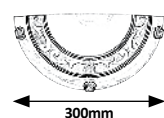

3713

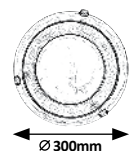

3714

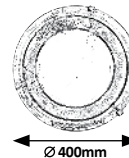

TOM



3481

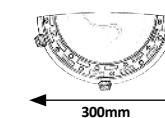

3483

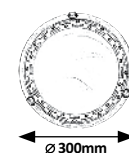

3484



3712 **MG**

☒ E27 / 1x max. 60W
IP20 • 9612
alabaster/gold/bronze



5 998250 337126

3713 **MG**

☒ E27 / 1x max. 60W
IP20 • 9613
alabaster/gold/bronze



5 998250 337135

3714 **MG**

☒ E27 / 2x max. 60W
IP20 • 9614
alabaster/gold/bronze



5 998250 337142

3481 **MG**

☒ E27 / 1x max. 60W
IP20 • 9477
alabaster/bronze



5 998250 334813

3483 **MG**

☒ E27 / 1x max. 60W
IP20 • 9478
alabaster/bronze



5 998250 334837

3484 **MG**

☒ E27 / 2x max. 60W
IP20 • 9479
alabaster/bronze



5 998250 334844

ETRUSCO



OTHERS / BEST MATCH 454.



7647

300mm



7648

Ø 300mm

7649

Ø 400mm

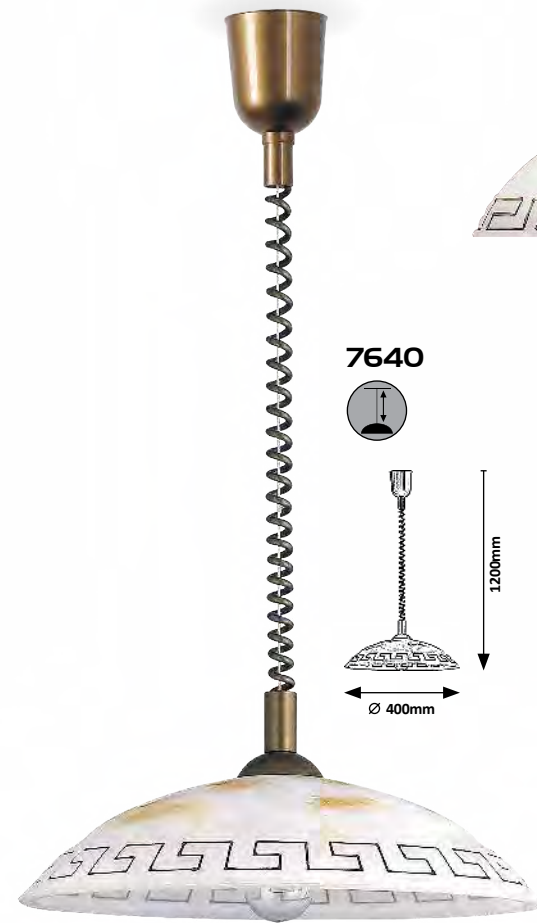

7640

1200mm
Ø 400mm

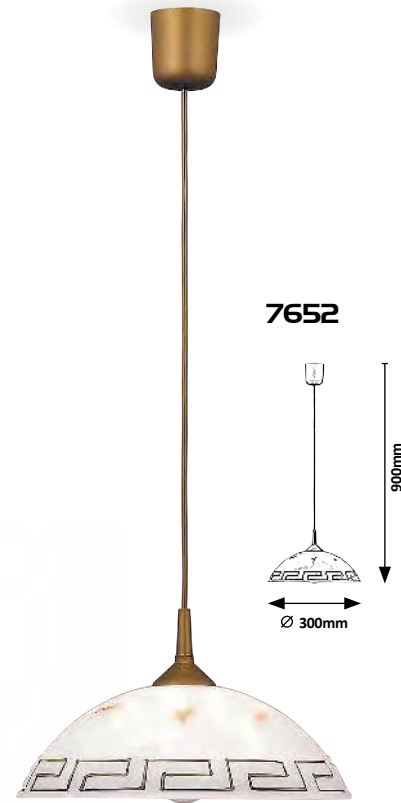

7652

900mm
Ø 300mm

7640 PG

☒ E27 / 1x max. 60W
IP20 • 9233
alabaster/brown/bronze



5 998250 376400

7647 MG

☒ E27 / 1x max. 60W
IP20 • 9234
alabaster/brown/bronze



5 998250 376479

7648 MG

☒ E27 / 1x max. 60W
IP20 • 9235
alabaster/brown/bronze



5 998250 376486

7649 MG

☒ E27 / 2x max. 60W
IP20 • 9236
alabaster/brown/bronze



5 998250 376493

7652 PG

☒ E27 / 1x max. 60W
IP20 • 9735
alabaster/brown/bronze



5 998250 376523

ALABASTRO



3053

300mm



3253

Ø 300mm

3353

Ø 400mm

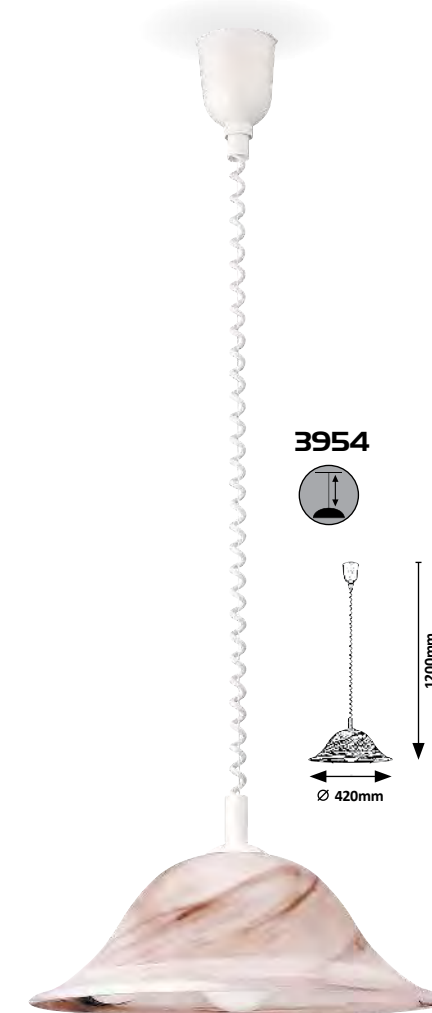

3954

1200mm
Ø 420mm

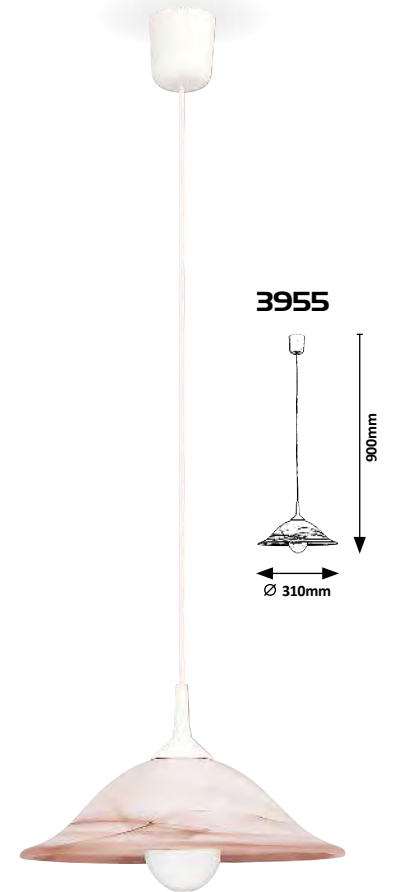

3955

900mm
Ø 310mm

3053 MG

☒ E27 / 1x max. 60W
IP20 • 9123
alabaster/tobacco/bronze



5 998250 330532

3253 MG

☒ E27 / 1x max. 60W
IP20 • 9111
alabaster/tobacco/bronze



5 998250 332536

3353 MG

☒ E27 / 2x max. 60W
IP20 • 9117
alabaster/tobacco/bronze



5 998250 333533

3954 PG

☒ E27 / 1x max. 60W
IP20 • 9141
alabaster/tobacco/white



5 998250 339542

3955 PG

☒ E27 / 1x max. 60W
IP20 • 9135
alabaster/tobacco/white



5 998250 339559

ALABASTRO



3001

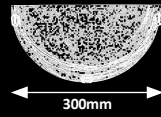

3002

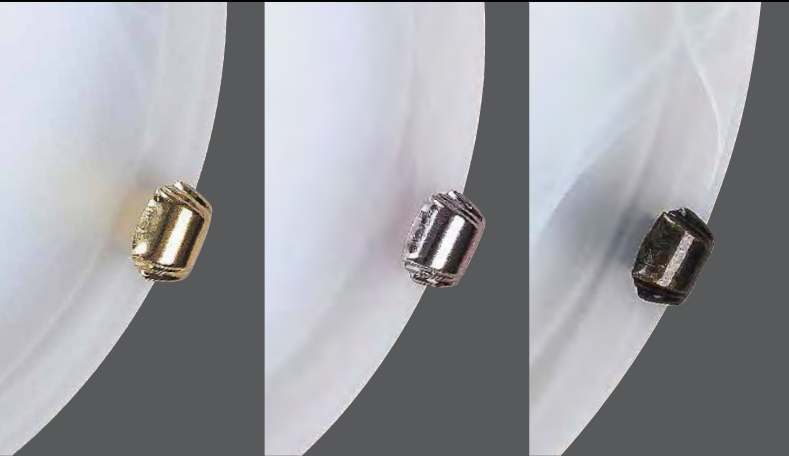
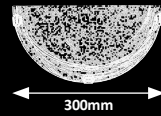

3201

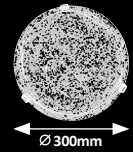

3301

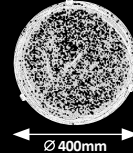

3202

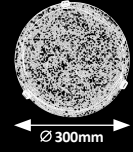

3302

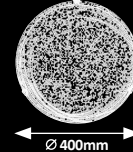

ALABASTRO



3003

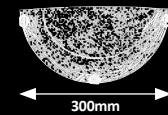

3203

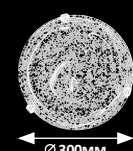

3303

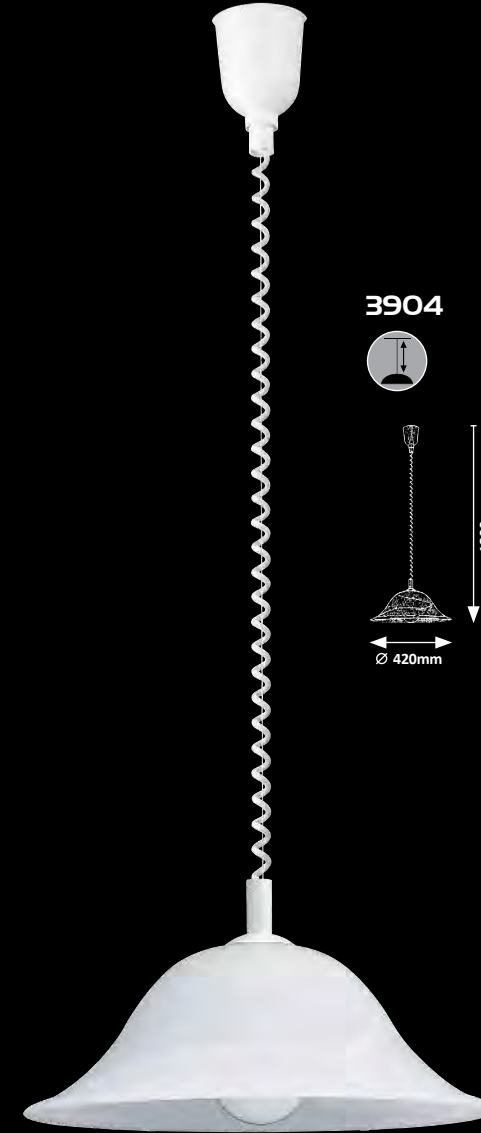
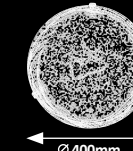

3904

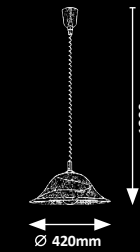

1200mm

Ø 420mm



3905

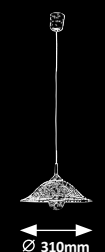

900mm

Ø 310mm

- | | | | | | |
|---|---|---|---|---|---|
| 3001 MG
E27 / 1x max. 60W
IP20 • 9119
alabaster/gold | 3002 MG
E27 / 1x max. 60W
IP20 • 9119
alabaster/chrome | 3201 MG
E27 / 1x max. 60W
IP20 • 9107
alabaster/gold | 3202 MG
E27 / 1x max. 60W
IP20 • 9107
alabaster/chrome | 3301 MG
E27 / 2x max. 60W
IP20 • 9113
alabaster/gold | 3302 MG
E27 / 2x max. 60W
IP20 • 9113
alabaster/chrome |
|---|---|---|---|---|---|

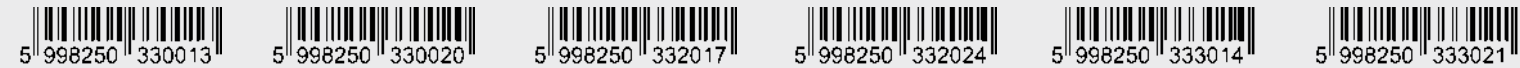

- | | | | | |
|---|---|---|--|--|
| 3003 MG
E27 / 1x max. 60W
IP20 • 9119
alabaster/bronze | 3203 MG
E27 / 1x max. 60W
IP20 • 9107
alabaster/bronze | 3303 MG
E27 / 2x max. 60W
IP20 • 9113
alabaster/bronze | 3904 PG
E27 / 1x max. 60W
IP20 • 9137
alabaster/white | 3905 PG
E27 / 1x max. 60W
IP20 • 9131
alabaster/white |
|---|---|---|--|--|





JOLLY

5 YEARS WARRANTY



1960

300mm



1861

Ø 300mm



1862

Ø 400mm

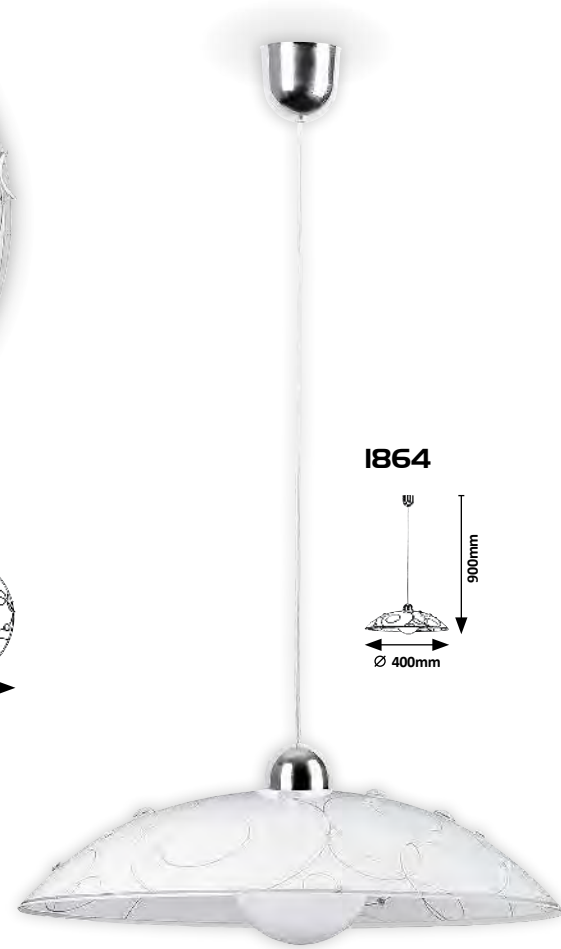

1864

900mm
Ø 400mm

1861 **MG**
 ☒ E27 / 1x max. 60W
 IP20 • 1195
 white/transparent/chrome



5 998250 318615

1862 **MG**
 ☒ E27 / 2x max. 60W
 IP20 • 1196
 white/transparent/chrome



5 998250 318622

1864 **PG**
 ☒ E27 / 1x max. 60W
 IP20 • 1198
 white/transparent/chrome



5 998250 318646

1960 **MG**
 ☒ E27 / 1x max. 60W
 IP20 • 1348
 white/transparent/chrome



5 998250 319605

ELINA

5 YEARS WARRANTY



3691

260mm
180mm



3692

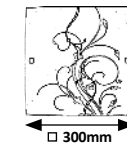

□ 300mm

3693



□ 400mm

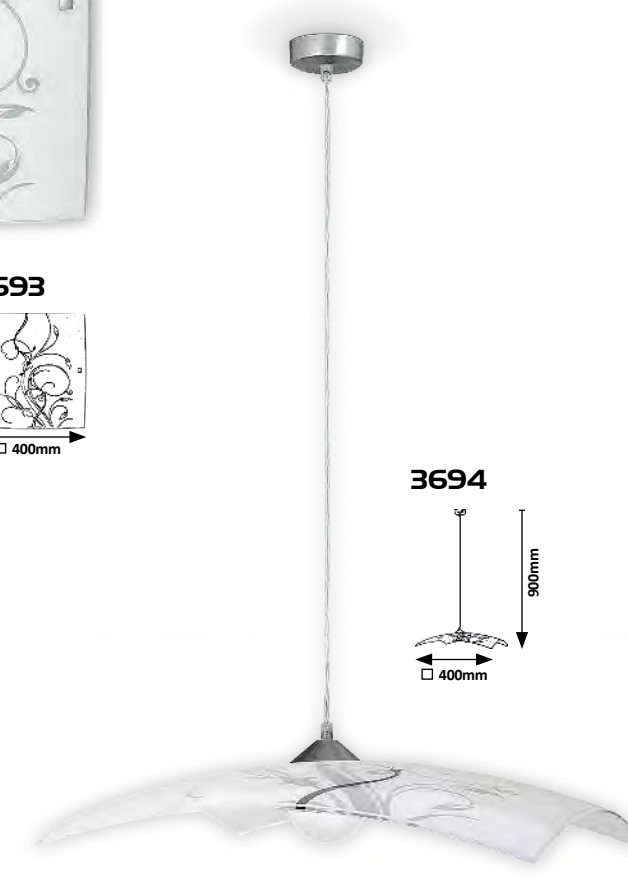

3694

900mm
□ 400mm

3691 **MG**
 ☒ E27 / G45 / 1x max. 60W
 IP20 • 1265
 white/grey/black



5 998250 336916

3692 **MG**
 ☒ E27 / 1x max. 60W
 IP20 • 1266
 white/grey/black



5 998250 336923

3693 **MG**
 ☒ E27 / 2x max. 60W
 IP20 • 1267
 white/grey/black



5 998250 336930

3694 **MG**
 ☒ E27 / 1x max. 60W
 IP20 • 1268
 white/grey/black/chrome



5 998250 336947





HARMONY LUX



OTHERS / BEST MATCH 311, 454.

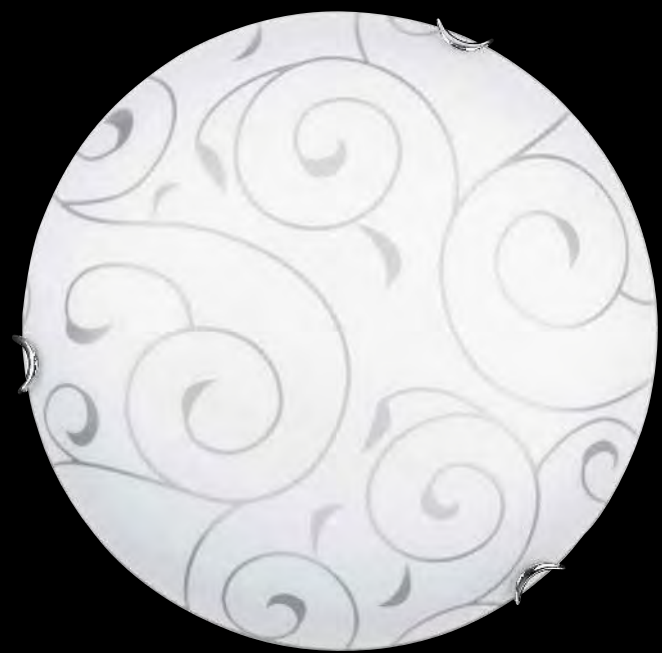
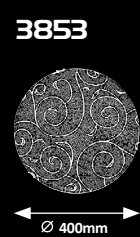

HARMONY LUX



OTHERS / BEST MATCH 311, 454.

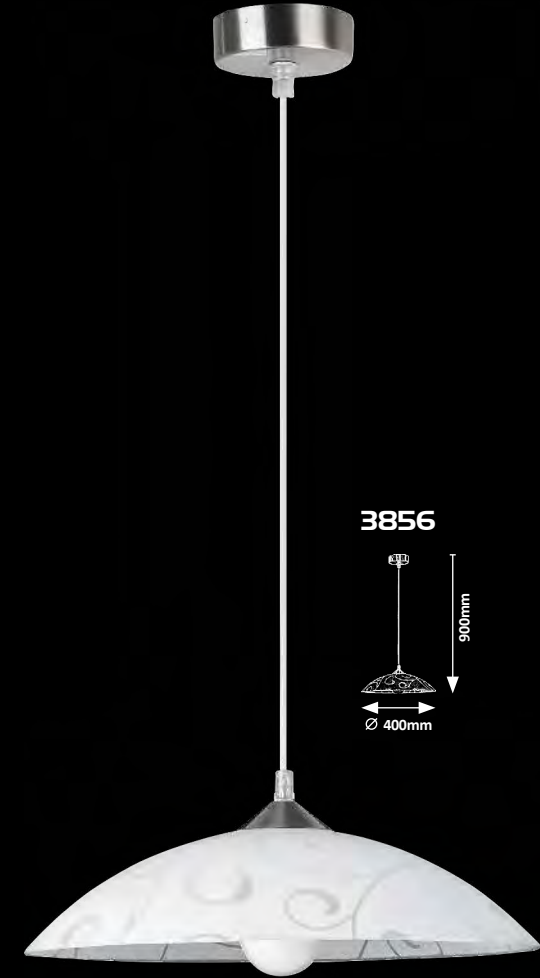
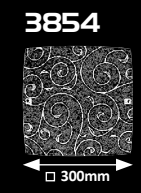

3851 MG
 ☒ E27 / 1x max. 60W
 IP20 • 9297
 white/transparent/chrome



3852 MG
 ☒ E27 / 1x max. 60W
 IP20 • 9302
 white/transparent/chrome



3853 MG
 ☒ E27 / 2x max. 60W
 IP20 • 9334
 white/transparent/chrome



3850 MG
 ☒ E27 / 1x max. 60W
 IP20 • 9403
 white/transparent/chrome



3854 MG
 ☒ E27 / 1x max. 60W
 IP20 • 9404
 white/transparent/chrome



3855 MG
 ☒ E27 / 2x max. 60W
 IP20 • 9408
 white/transparent/chrome



3856 MG
 ☒ E27 / 1x max. 60W
 IP20 • 9427
 white/transparent/chrome



IRIS

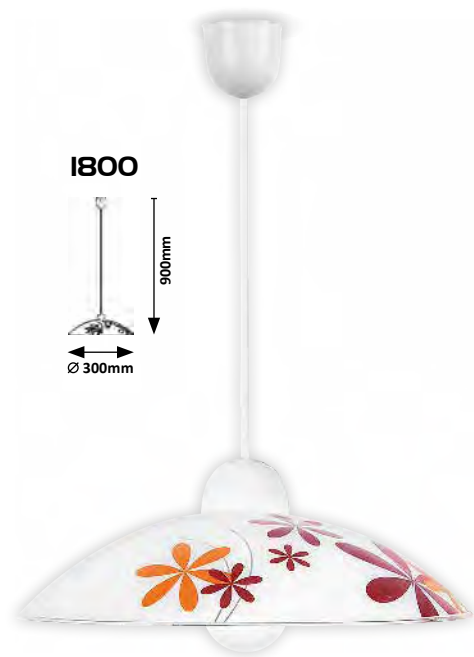

1800
900mm
Ø 300mm

ADA

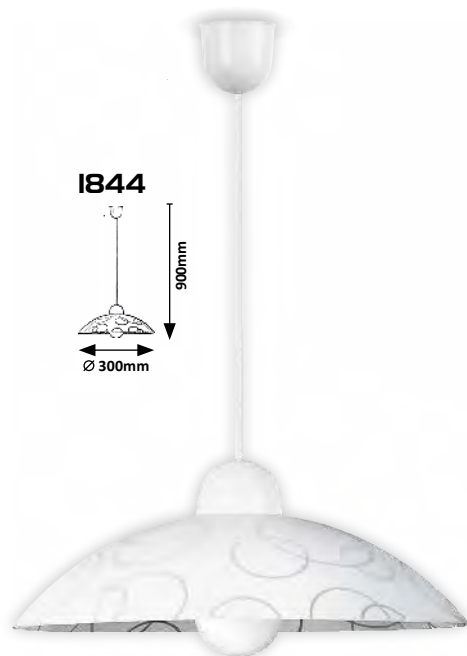

1844
900mm
Ø 300mm

SCROLL

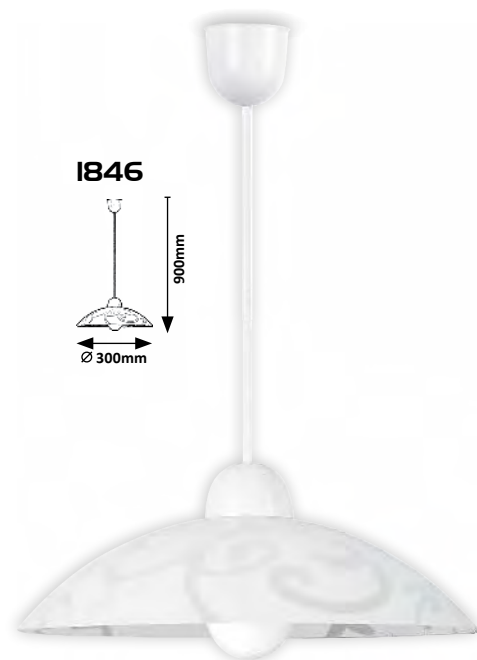

1846
900mm
Ø 300mm

BLOOMY



1847

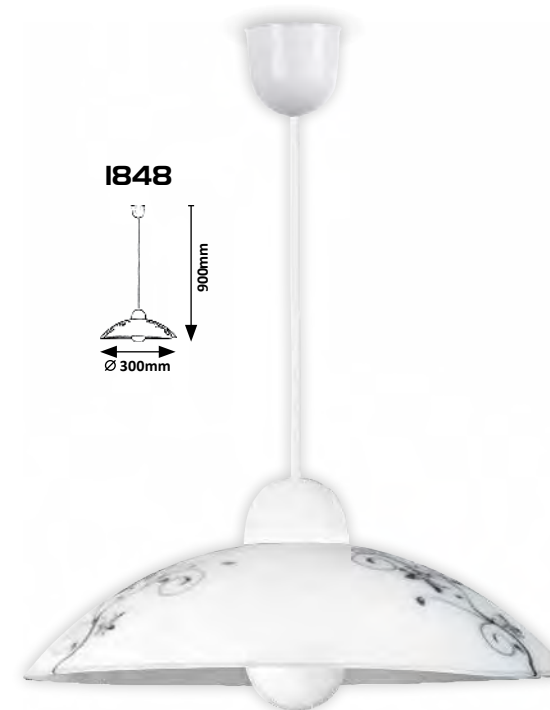
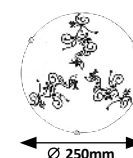

1848
900mm
Ø 300mm

VINO



4782
900mm
Ø 400mm

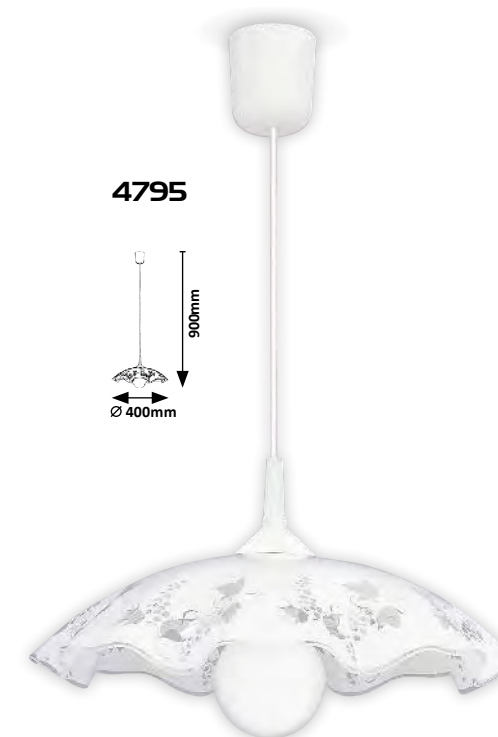

4795
900mm
Ø 400mm



- 1800** PG E27 / 1x max. 60W IP20 • 1209 multicolour/white
- 1896** MPG E27 / 1x max. 60W IP20 • 1226 multicolour/white
- 1843** MPG E27 / 1x max. 60W IP20 • 9682 white/transparent
- 1844** PG E27 / 1x max. 60W IP20 • 9686 white/transparent
- 1845** MPG E27 / 1x max. 60W IP20 • 9681 white/transparent
- 1846** PG E27 / 1x max. 60W IP20 • 9685 white/transparent



- 1847** MPG E27 / 1x max. 60W IP20 • 9272 white/black
- 1848** PG E27 / 1x max. 60W IP20 • 9278 white/black
- 4782** PG E27 / 1x max. 60W IP20 • 9184 white/orange
- 4795** PG E27 / 1x max. 60W IP20 • 9186 white/silver

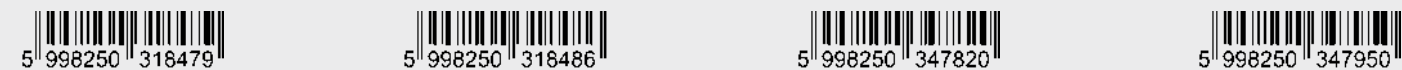

SIMPLE



1803

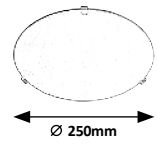

Ø 250mm

SPIRAL



1822

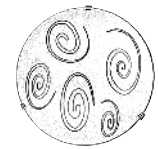

Ø 250mm

SOLEY



1814

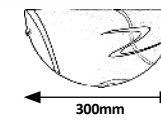

300mm



1817



300mm



1815

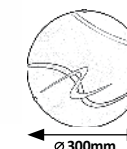

Ø 300mm



1818

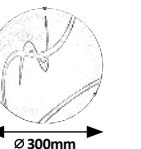

Ø 300mm

1819

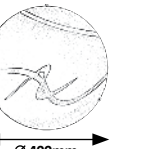

Ø 400mm



1803 M P G

☒ E27 / 1x max. 60W
IP20 • 9010
white/transparent



5 998250 318035

1822 M P G

☒ E27 / 1x max. 60W
IP20 • 9034
white/transparent



5 998250 318226

1814 M P G

☒ E27 / 1x max. 60W
IP20 • 9024
white/orange/transparent



5 998250 318141

1815 M P G

☒ E27 / 1x max. 60W
IP20 • 9027
white/orange/transparent



5 998250 318156

1817 M P G

☒ E27 / 1x max. 60W
IP20 • 9025
white/transparent



5 998250 318172

1818 M P G

☒ E27 / 1x max. 60W
IP20 • 9028
white/transparent



5 998250 318189

1819 M P G

☒ E27 / 2x max. 60W
IP20 • 9031
white/transparent



5 998250 318196

SCOTTIE



3887

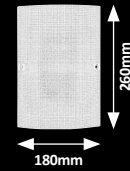

3888

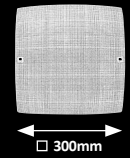

3889

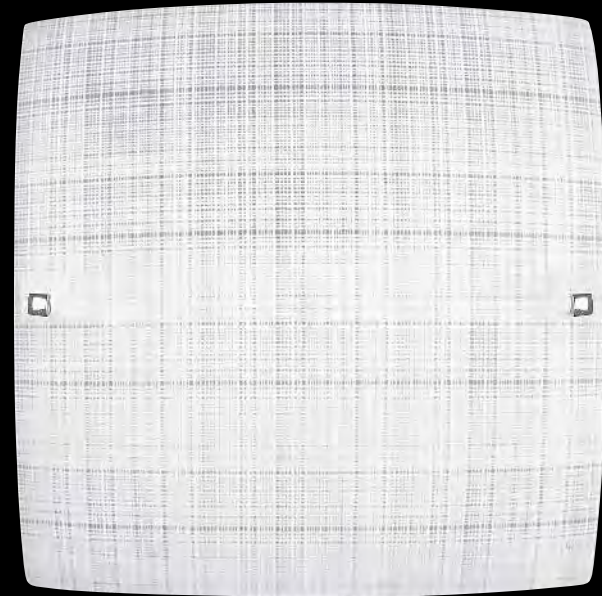
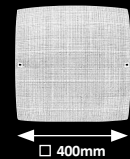

3697

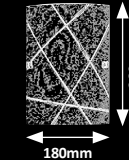

3698

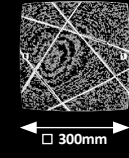

3699

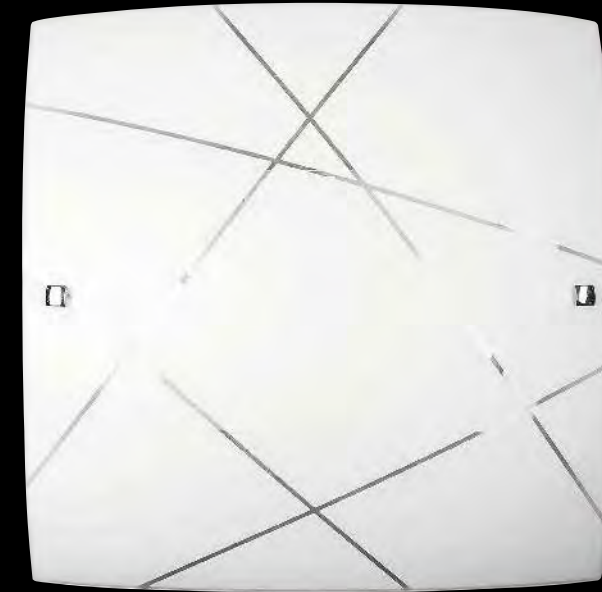
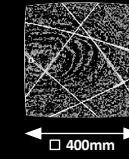

3887 MG

☒ E27 / G45 / 1x max. 60W
IP20 • 9373
white/chrome



5 998250 338873

3888 MG

☒ E27 / 1x max. 60W
IP20 • 9374
white/chrome



5 998250 338880

3889 MG

☒ E27 / 2x max. 60W
IP20 • 9375
white/chrome



5 998250 338897

3697 MG

☒ E27 / G45 / 1x max. 60W
IP20 • 1344
white/chrome/transparent



5 998250 336978

3698 MG

☒ E27 / 1x max. 60W
IP20 • 1339
white/chrome/transparent



5 998250 336985

3699 MG

☒ E27 / 2x max. 60W
IP20 • 1340
white/chrome/transparent



5 998250 336992

NEDDA



3687

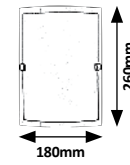

3688

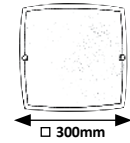

3689



STEFANY



5702

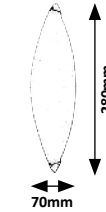

OPALE



5726

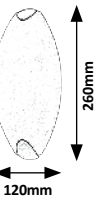

CHARLES

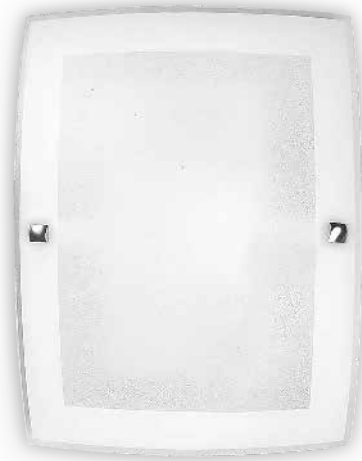

3837

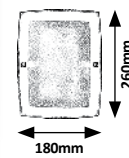

3838

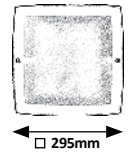

3839

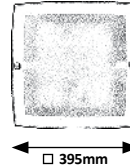

DISKY



3563

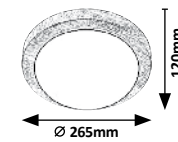

3564

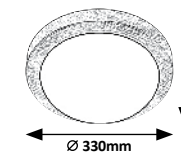

3567

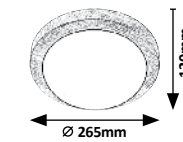

3568

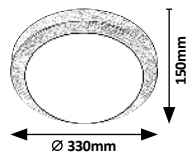

- | | | | | | |
|--|--|--|---|---|---|
| 3687 MG
E27 / 1x max. 60W
IP20 • 1319
opal glass/transparent | 3688 MG
E27 / 1x max. 60W
IP20 • 1346
opal glass/transparent | 3689 MG
E27 / 2x max. 60W
IP20 • 1347
opal glass/transparent | 3837 MG
E27 / 1x max. 60W
IP20 • 600
opal glass/transparent | 3838 MG
E27 / 1x max. 60W
IP20 • 601
opal glass/transparent | 3839 MG
E27 / 2x max. 60W
IP20 • 602
opal glass/transparent |
|--|--|--|---|---|---|



5 998250 336879

5 998250 336886

5 998250 336893

5 998250 338378

5 998250 338385

5 998250 338392

- | | | | | | |
|--|--|---|---|--|--|
| 5702 MG
E14 / 1x max. 40W
IP20 • 9159
chrome/alabaster | 5726 MG
E27 / 1x max. 60W
IP20 • 9512
chrome/alabaster | 3563 MG
E27 / 1x max. 40W
IP20 • 9565
bronze/opal glass | 3564 MG
E27 / 2x max. 40W
IP20 • 9551
bronze/opal glass | 3567 MG
E27 / 1x max. 40W
IP20 • 9565
wenge/opal glass | 3568 MG
E27 / 2x max. 40W
IP20 • 9551
wenge/opal glass |
|--|--|---|---|--|--|

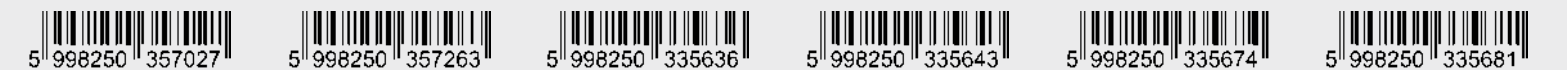

5 998250 357027

5 998250 357263

5 998250 335636

5 998250 335643

5 998250 335674

5 998250 335681

UFO



5401

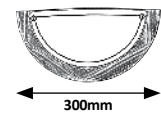

5421

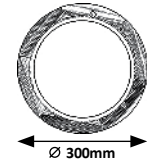

5421



5407

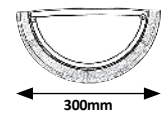

5427

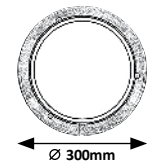

5427

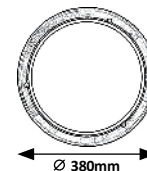

UFO



5173

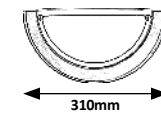

5143

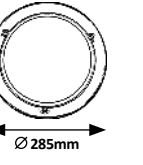

5143

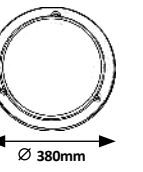

5181

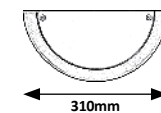

5151

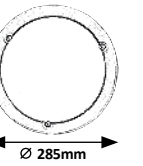

5151

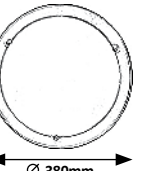

5401 MWG

☒ E27 / 1x max. 60W
IP20 • 9105
natural/opal glass



5407 MWG

☒ E27 / 1x max. 60W
IP20 • 9105
oak/opal glass



5421 MWG

☒ E27 / 1x max. 60W
IP20 • 9101
natural/opal glass



5427 MWG

☒ E27 / 1x max. 60W
IP20 • 9101
oak/opal glass



5421 MWG

☒ E27 / 2x max. 60W
IP20 • 9103
natural/opal glass



5427 MWG

☒ E27 / 2x max. 60W
IP20 • 9103
oak/opal glass



5173 MG

☒ E27 / 1x max. 60W
IP20 • 9900
chrome/opal glass



5121 MG

☒ E27 / 1x max. 60W
IP20 • 9903
satin chrome/white



5143 MG

☒ E27 / 2x max. 60W
IP20 • 9103
chrome/opal glass



5151 MG

☒ E27 / 2x max. 60W
IP20 • 9200
satin chrome/white



5173 MG

☒ E27 / 1x max. 60W
IP20 • 9105
chrome/opal glass



5181 MG

☒ E27 / 1x max. 60W
IP20 • 9053
satin chrome/white



UFO



5263

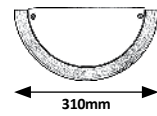

5203

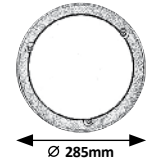

5233

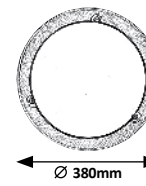

5163

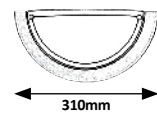

5103

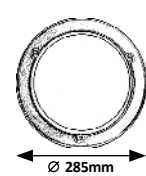

5203 MG

☒ E27 / 1x max. 60W
IP20 • 9903
bronze/white



5 998250 352039

5233 MG

☒ E27 / 2x max. 60W
IP20 • 9200
bronze/white



5 998250 352336

5263 MG

☒ E27 / 1x max. 60W
IP20 • 9053
bronze/white



5 998250 352633

5103 MG

☒ E27 / 1x max. 60W
IP20 • 9900
black/opal glass



5 998250 351032

5163 MG

☒ E27 / 1x max. 60W
IP20 • 9105
black/opal glass



5 998250 351636

UFO



5161

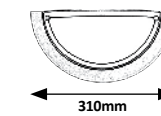

5101

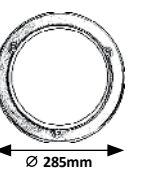

5131

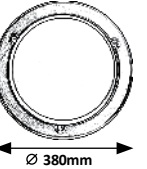

GRACE



2431

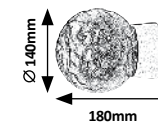

2432

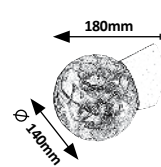

5101 MG

☒ E27 / 1x max. 60W
IP20 • 9900
white/opal glass



5 998250 351018

5131 MG

☒ E27 / 2x max. 60W
IP20 • 9103
white/opal glass



5 998250 351315

5161 MG

☒ E27 / 1x max. 60W
IP20 • 9105
white/opal glass



5 998250 351612

2431 PG

☒ E27 / 1x max. 60W
IP20 • 2416
white/transparent



5 998250 324319

2432 PG

☒ E27 / 1x max. 60W
IP20 • 2416
white/transparent



5 998250 324326

CUPOLA RANGE

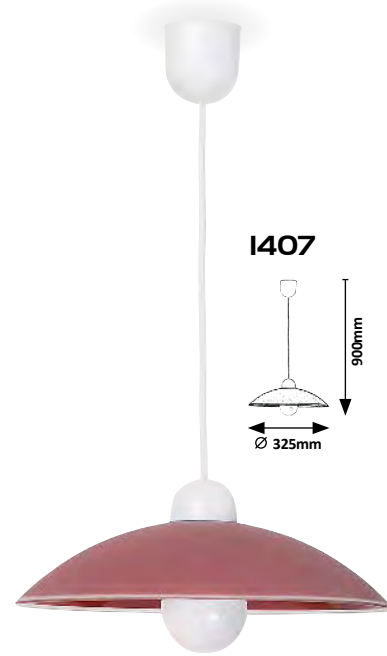

I407

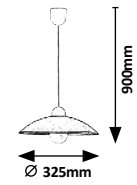

4613

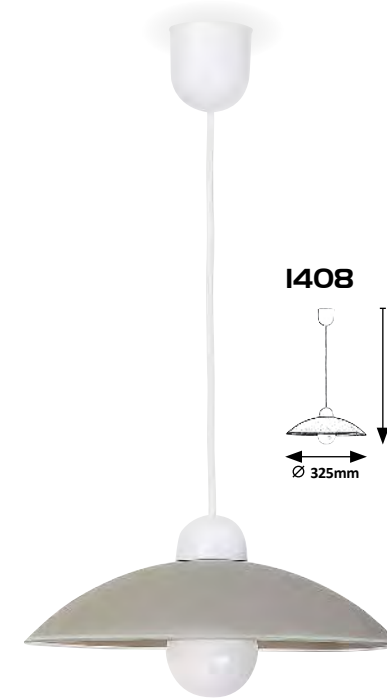
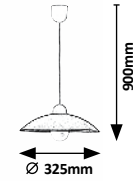

I408

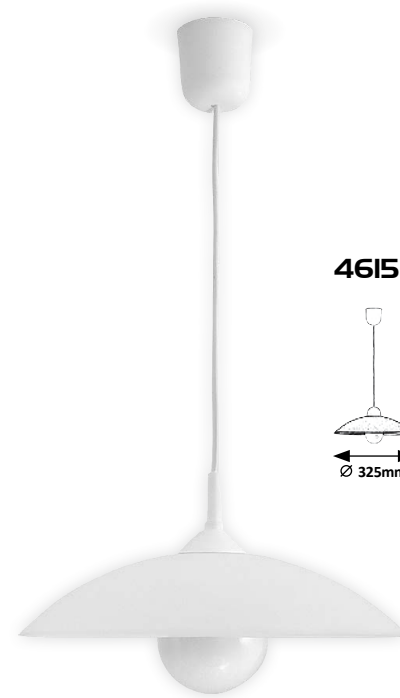
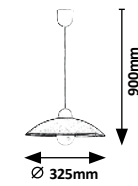

4615

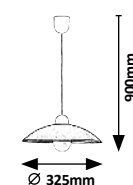

SMERLATO



4675

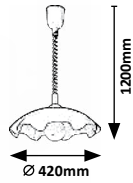

ROUND

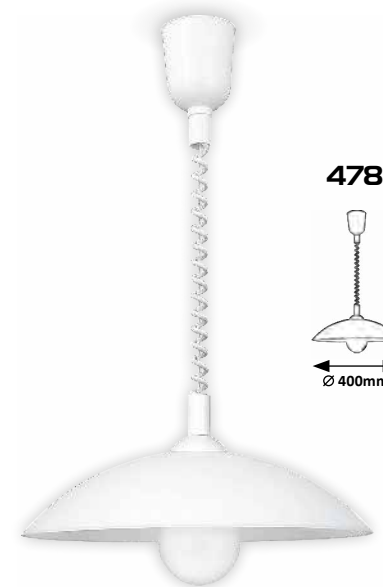

4780

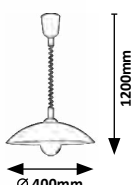

MORRIS



5058

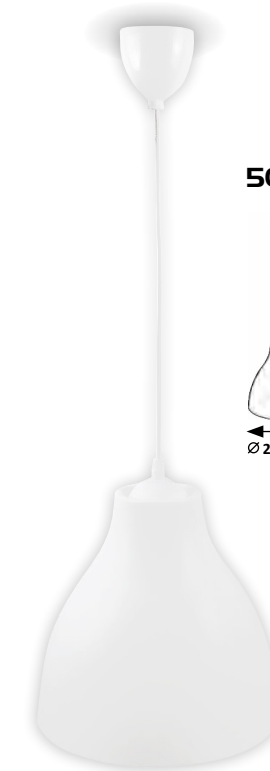
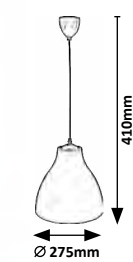

5059

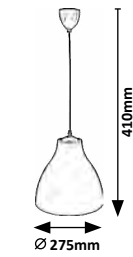

5060

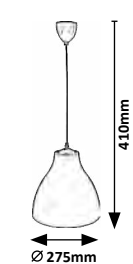

OTHERS / BEST MATCH 442.



4894



4898



I407 PG

☒ E27 / 1x max. 60W
IP20 • 742
claret/white



5 998250 314075

I408 PG

☒ E27 / 1x max. 60W
IP20 • 743
grey/white



5 998250 314082

4613 PG

☒ E27 / 1x max. 60W
IP20 • 9311
orange/white



5 998250 346137

4615 PG

☒ E27 / 1x max. 60W
IP20 • 9313
white



5 998250 346151

4675 PG

☒ E27 / 1x max. 60W
IP20 • 9156
white



5 998250 346755

4780 PG

☒ E27 / 1x max. 60W
IP20 • 9182
white



5 998250 347806

5058 P

☒ E27 / 1x max. 40W
IP20
green/white



5 998250 350585

5059 P

☒ E27 / 1x max. 40W
IP20
white



5 998250 350592

5060 P

☒ E27 / 1x max. 40W
IP20
grey/white



5 998250 350608

4894 M PA

☒ white



5 998250 348940

4898 M PA

☒ white



5 998250 348986



FIXY

TEXTILE CABLE

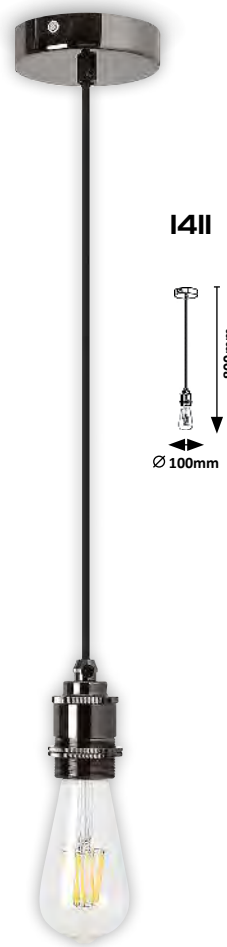

I411
800mm
Ø 100mm



I417
800mm
Ø 100mm

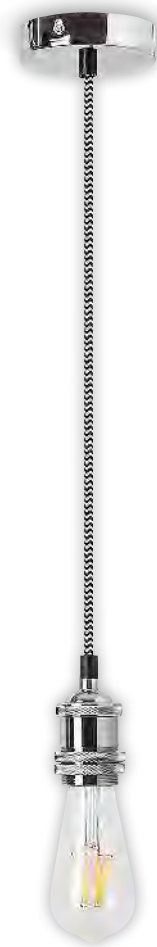

I418
800mm
Ø 100mm

ROXY

TEXTILE CABLE



I412
1500mm
Ø 80mm



I414
1500mm
Ø 80mm

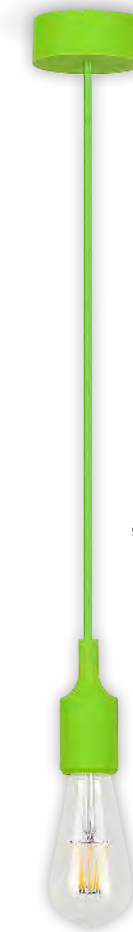

I415
1500mm
Ø 80mm



I411 **MT**
E27 / 1x max. 60W
IP20
black



5 998250 314112

I417 **MT**
E27 / 1x max. 60W
IP20
bronze



5 998250 314174

I418 **MT**
E27 / 1x max. 60W
IP20
silver



5 998250 314181

I412 **SI**
E27 / 1x max. 60W
IP20
black



5 998250 314129

I414 **SI**
E27 / 1x max. 60W
IP20
red



5 998250 314143

I415 **SI**
E27 / 1x max. 60W
IP20
green



5 998250 314150

FIX



I331 (P)	I332 (P)	I338 (M)	9919 (P)	9920 (P)	9926 (M)
☒ E27 / 1x max. 60W IP20 chrome	☒ E27 / 1x max. 60W IP20 transparent	☒ E27 / 1x max. 60W IP20 chrome	☒ E27 / 1x max. 60W IP20 white	☒ E27 / 1x max. 60W IP20 bronze	☒ E27 / 1x max. 60W IP20 satin chrome



ROLLY



9921 (P)	9923 (P)
☒ E27 / 1x max. 60W IP20 white	☒ E27 / 1x max. 60W IP20 bronze

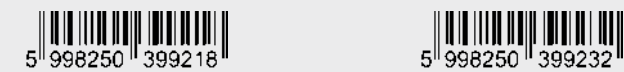

ROLLY PULL

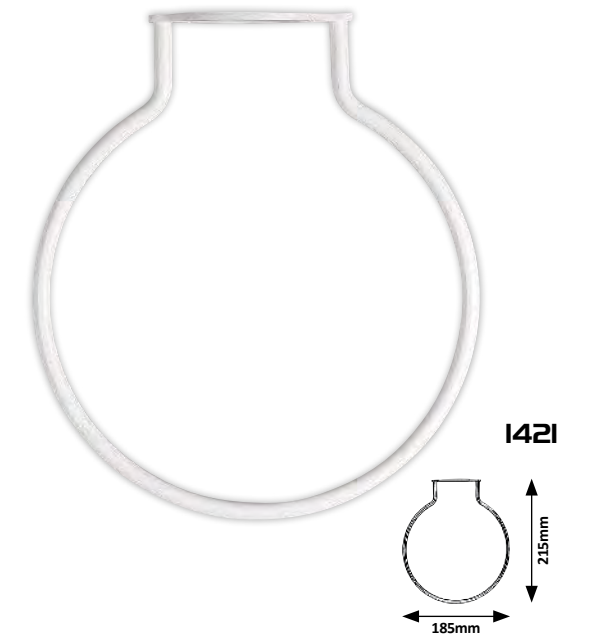

BOTTOM



I421 (P)	I301 (M)
white	☒ E27 / 1x max. 60W IP20 chrome

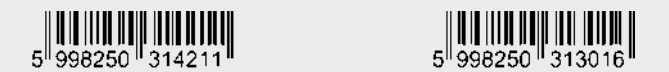



08

**TABLE AND FLOOR
LAMPS**

ASZTALI- ÉS ÁLLÓLÁMPÁK

TISCH- UND STEHLAMPEN



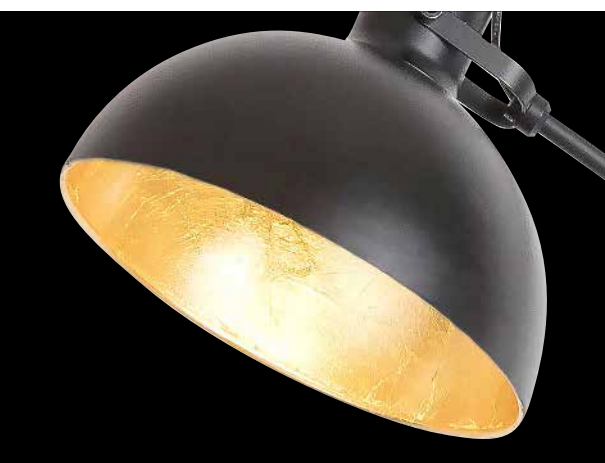

OTTO



DARON

NEW

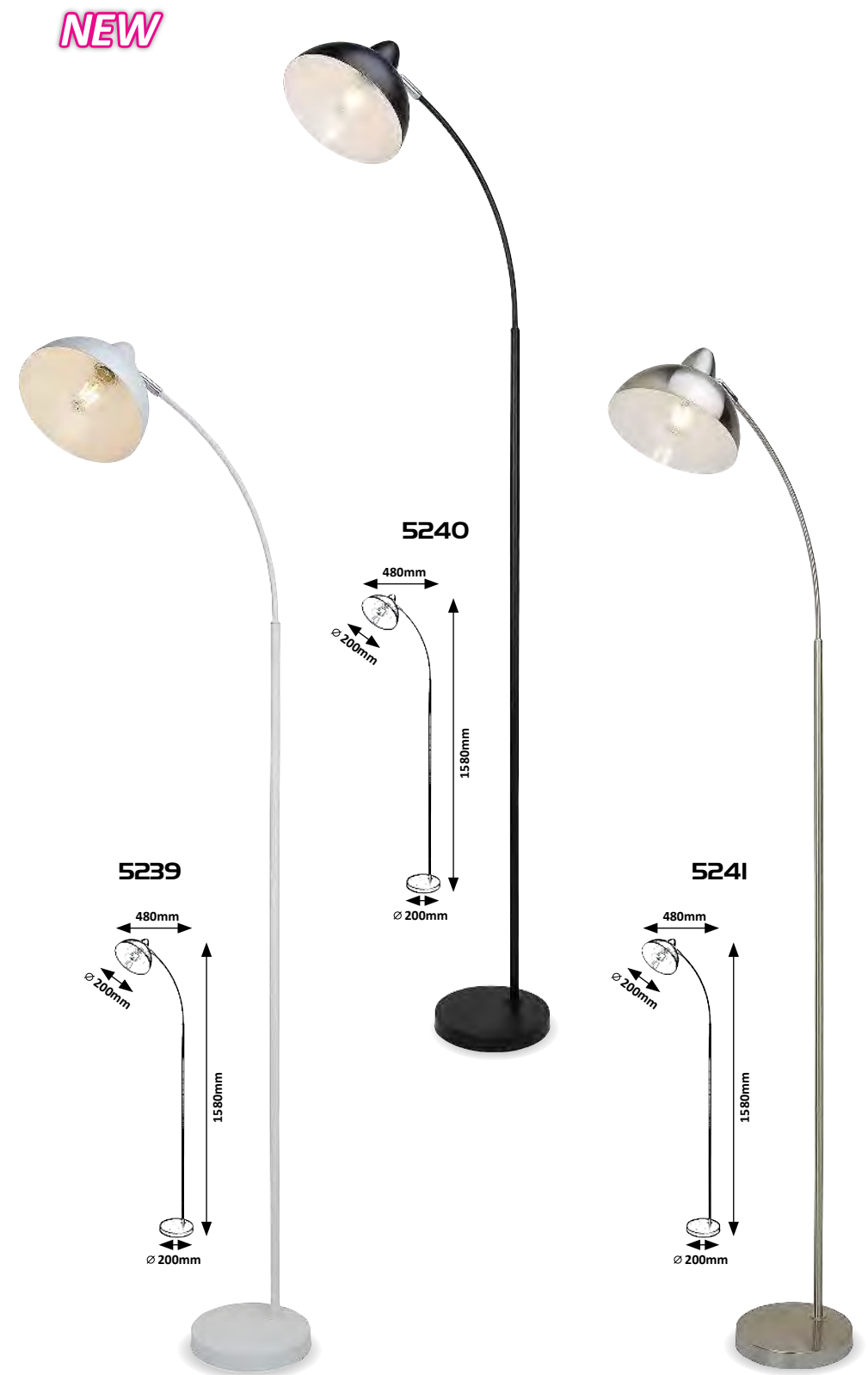

5592 **(M)**

☒ E27 / 1x max. 60W
IP20 • •
matte black/gold foil



5 998250 355924

5593 **(M)**

☒ E27 / 1x max. 60W
IP20 • •
satin chrome/white



5 998250 355931

5594 **(M)**

☒ E27 / 1x max. 60W
IP20 • •
matte white/silver foil



5 998250 355946

5239 **(M)**

☒ E27 / 1x max. 40W
IP20 • •
matte white



5 998250 352398

5240 **(M)**

☒ E27 / 1x max. 40W
IP20 • •
matte black



5 998250 352404

5241 **(M)**

☒ E27 / 1x max. 40W
IP20 • •
satin chrome



5 998250 352411



DEREK

OTHERS / BEST MATCH 135.



4328 (M)
 ☒ E27 / 1x max. 25W
 IP20 •
 white

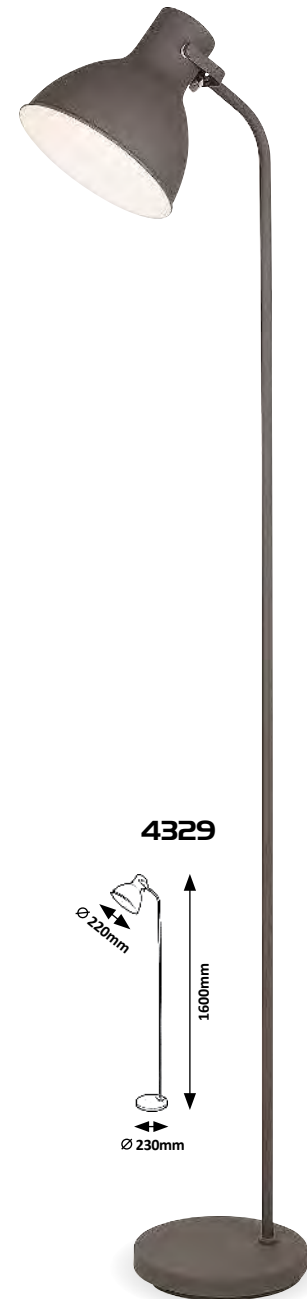

4329 (M)
 ☒ E27 / 1x max. 25W
 IP20 •
 grey



MALIA

OTHERS / BEST MATCH 132. **NEW**

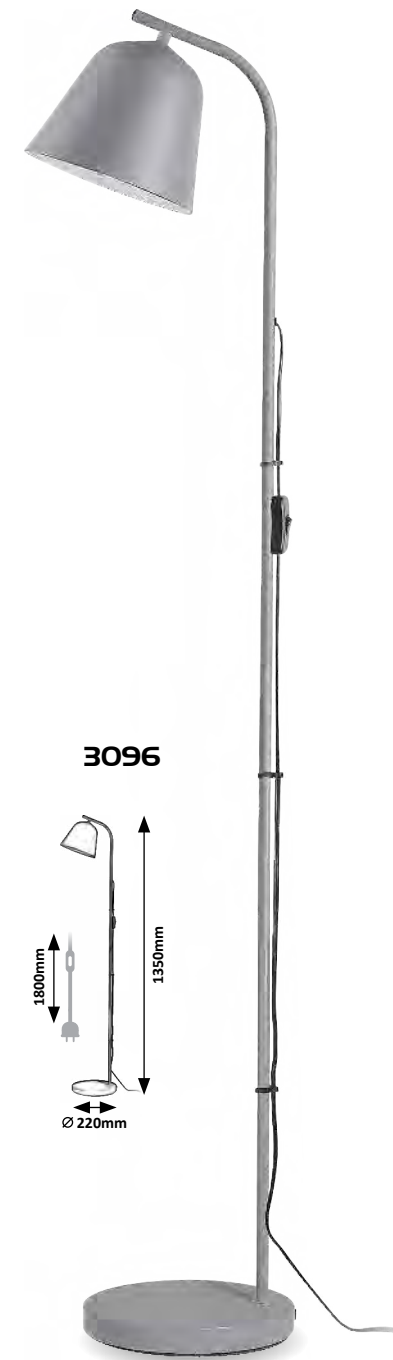

3096 (M)
 ☒ E27 / 1x max. 25W
 IP20 •
 grey/white



DRAGAN

OTHERS / BEST MATCH 130-131. **NEW**



5310 (M)
 ☒ E27 / 1x max. 60W
 IP20 •
 matte black/white



MALIET

OTHERS / BEST MATCH 145.

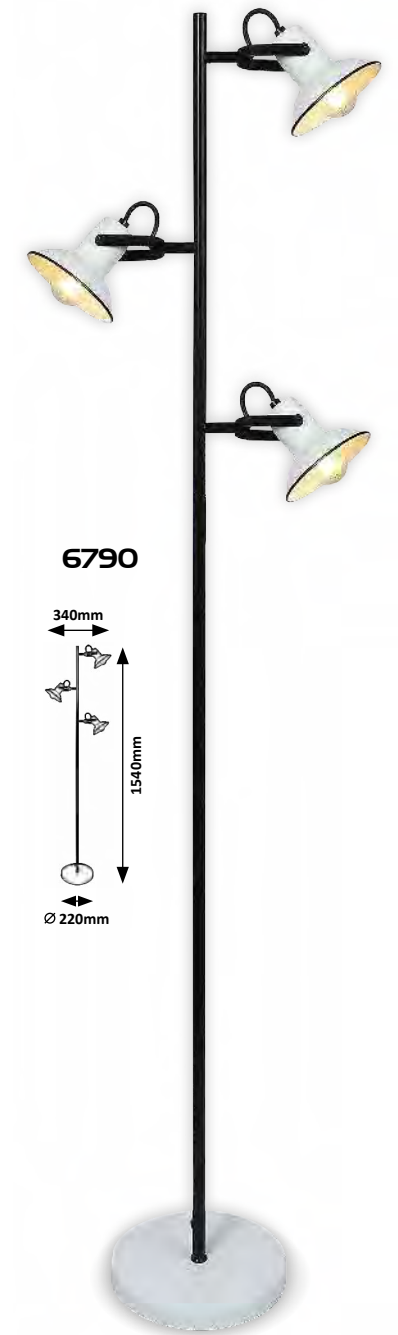

6790 (M)
 ☒ E14 / 3x max. 40W
 IP20 •
 black/white



LESLIE



AARON



VLASTA



OPHUS

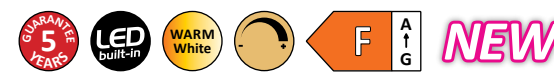

4159



LED 18W



LED 4W

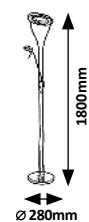

1800mm
Ø 280mm



4162

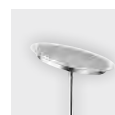

LED 18W



LED 5W

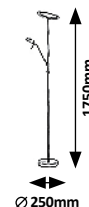

1750mm
Ø 250mm



7006



LED 18W



LED 5W



1820mm
Ø 250mm



3239



LED 18,5W



LED 4,5W



1800mm
Ø 255mm



3240



LED 18,5W



LED 4,5W

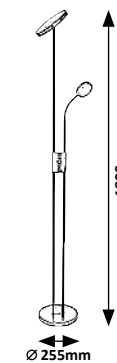

1800mm
Ø 255mm

4159 MG

LED / 18W (1600lm, 3000K) +
LED / 4W (280lm, 3000K) incl.
IP20 • 19263 • 19262
chrome



5 998250 341590

4162 MG

LED / 18W (1400lm, 3000K) +
LED / 5W (400lm, 3000K) incl.
IP20 • 19318 • 19319
satin chrome/transparent



5 998250 341620

7006 MP

LED / 18W (1400lm, 3000K) +
LED / 5W (400lm, 3000K) incl.
IP20 • 19440
satin chrome



5 998250 370064

3239 MG

LED / 18,5W (1750lm, 3000K) incl. +
LED / 4,5W (360lm, 3000K) incl.
IP20 • 19897 • 19898 •
satin chrome/transparent



5 998250 332390

3240 MG

LED / 18,5W (1750lm, 3000K) incl. +
LED / 4,5W (360lm, 3000K) incl.
IP20 • 19897 • 19898 •
matte black/transparent



5 998250 332406



3239, 3240

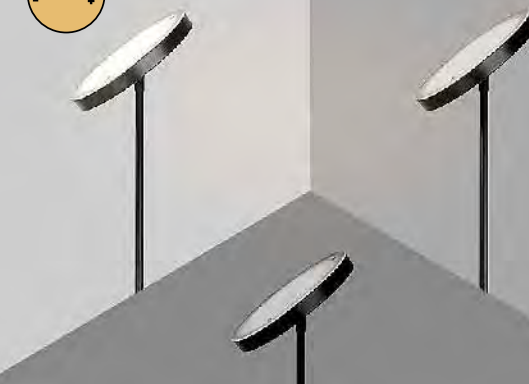

BETA

GAMMA TREND

GAMMA



4075



R7s
1x max. 230W

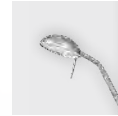

G9
1x max. 40W

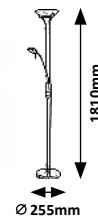

4076



R7s
1x max. 230W

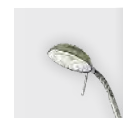

G9
1x max. 40W

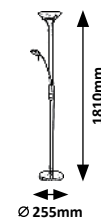

4554



E27
2x max. 15W



G9
1x max. 40W

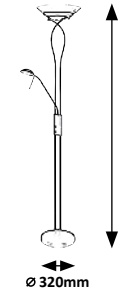

4555



E27
2x max. 15W



G9
1x max. 40W

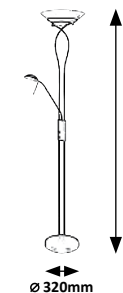

4077



R7s
1x max. 230W

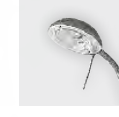

G9
1x max. 40W

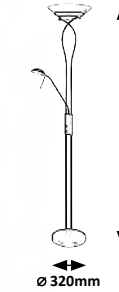

4078

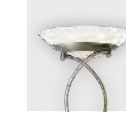

R7s
1x max. 230W

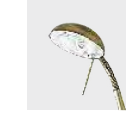

G9
1x max. 40W

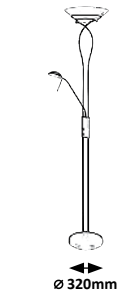

4075 MG

☑ 230W (4600lm, 2700K) + 28W (370lm, 2700K) incl.
R7s / 1x max. 230W + G9 / 1x max. 40W
IP20 • • 19004 • satin chrome



5 998250 340753

4076 MG

☑ 230W (4600lm, 2700K) + 28W (370lm, 2700K) incl.
R7s / 1x max. 230W + G9 / 1x max. 40W
IP20 • • 19004 • bronze



5 998250 340760

4554 MG

☑ E27 / 2x max. 15W + G9 / 1x max. 40W
IP20 • • 19002 • 19003
matte black/white



5 998250 345543

4555 MG

☑ E27 / 2x max. 15W + G9 / 1x max. 40W
IP20 • • 19002 • 19003
antique white/white



5 998250 345550

4077 MG

☑ 230W (4600lm, 2700K) + 28W (370lm, 2700K) incl.
R7s / 1x max. 230W + G9 / 1x max. 40W
IP20 • • 19002 • 19003
satin chrome/white



5 998250 340777

4078 MG

☑ 230W (4600lm, 2700K) + 28W (370lm, 2700K) incl.
R7s / 1x max. 230W + G9 / 1x max. 40W
IP20 • • 19002 • 19003
bronze/white



5 998250 340784



ART FLOWER



OTHERS / BEST MATCH 224-225.

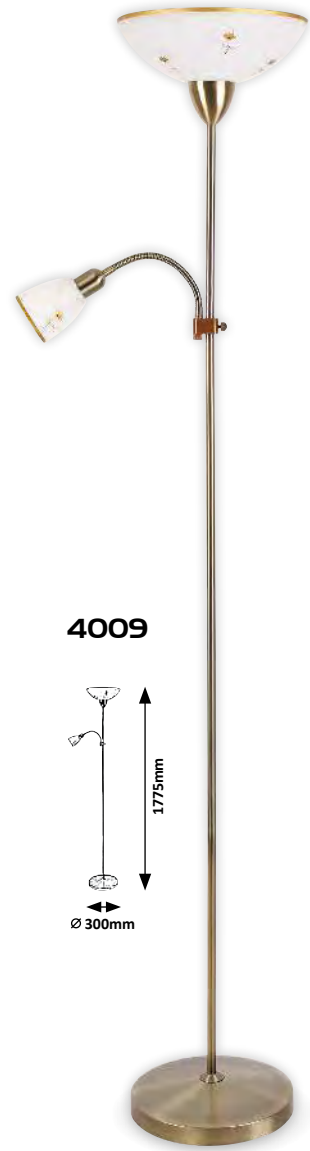

4009

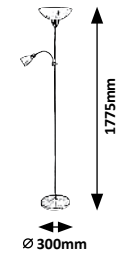

4009

HARMONY

OTHERS / BEST MATCH 424-425.



4091

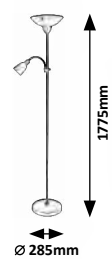

ETRUSCO

OTHERS / BEST MATCH 418.



6968

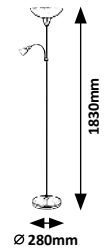

DIANA

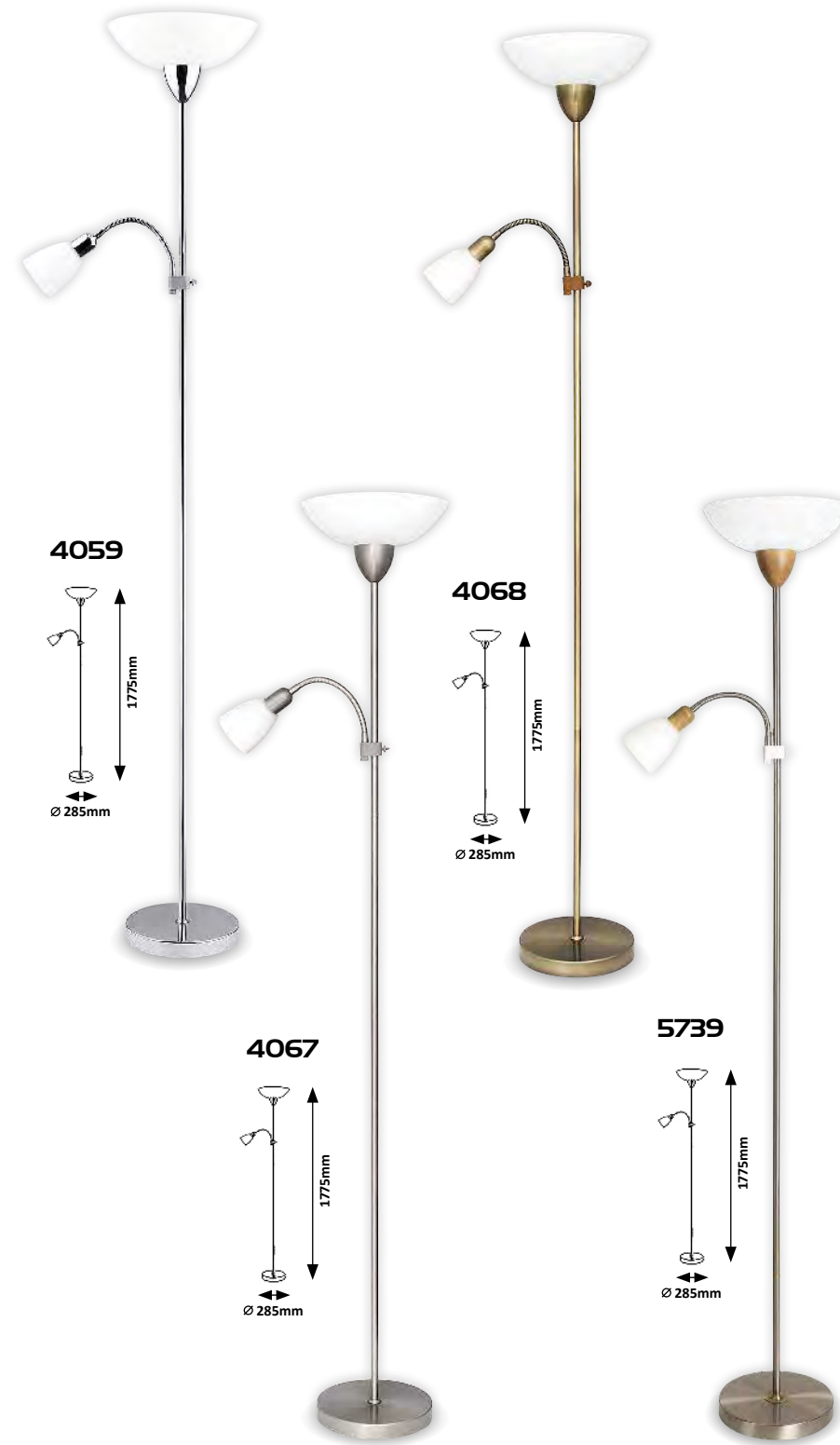

4059

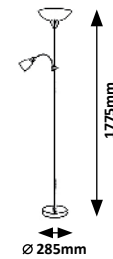

4068

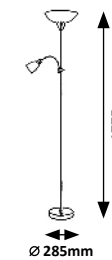

4067

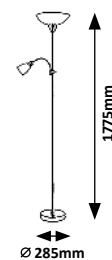

5739

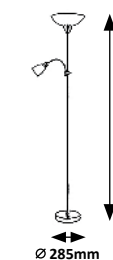

PEARL CLASSIC

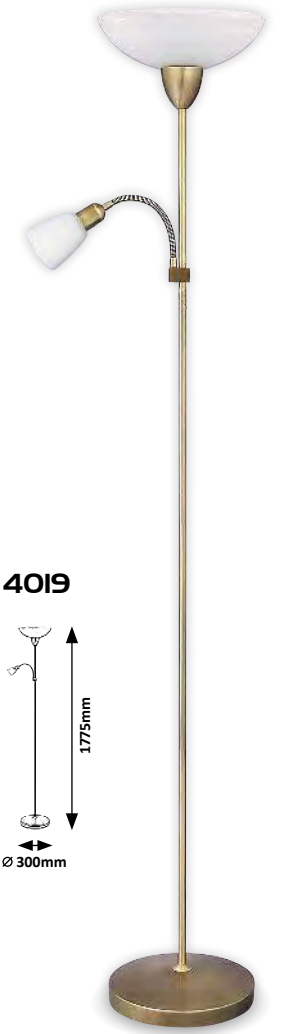

4019

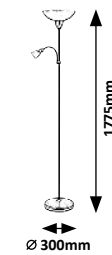

5739

4009 MG

E27 / G45 / 1x max. 60W + E14 / 1x max. 40W
IP20 • 1168 • 1169
alabaster/bronze



5 998250 340098

4091 MG

E27 / 1x max. 100W + E14 / 1x max. 40W
IP20 • 19005 • 19006
satin chrome/white/grey



5 998250 340913

6968 MG

E27 / 1x max. 100W + E14 / 1x max. 40W
IP20 • 9597 • 9598
black/alabaster/brown



5 998250 369686

4019 MG

E27 / G45 / 1x max. 60W + E14 / 1x max. 40W
IP20 • 9584 • 9585
bronze/alabaster



5 998250 340197

4059 MGP

E27 / G45 / 1x max. 60W + E14 / 1x max. 40W
IP20 • 9867 • 9868
chrome/white



5 998250 340593

4067 MGP

E27 / G45 / 1x max. 60W + E14 / 1x max. 40W
IP20 • 9867 • 9868
satin chrome/white



5 998250 340678

4068 MGP

E27 / G45 / 1x max. 60W + E14 / 1x max. 40W
IP20 • 9867 • 9868
bronze/white



5 998250 340685

5739 MGP

E27 / G45 / 1x max. 40W + E14 / 1x max. 40W
IP20 • 9867 • 9868
satin chrome/beechnopal glass



5 998250 357393



ACTION



ACTION



4026 (MP)

☒ E27 / 1x max. 100W +
E14 / 1x max. 25W
IP20 • 9808 • 9809
silver/orange



5 998250 340265

4028 (MP)

☒ E27 / 1x max. 100W +
E14 / 1x max. 25W
IP20 • 9871 • 9872
silver/white



5 998250 340289

4060 (MP)

☒ E27 / 1x max. 100W +
E14 / 1x max. 25W
IP20 • 9871 • 9872
gold/white



5 998250 340609

4061 (MP)

☒ E27 / 1x max. 100W +
E14 / 1x max. 25W
IP20 • 9871 • 9872
white



5 998250 340616

4020 (MP)

☒ E27 / 1x max. 100W +
E14 / 1x max. 25W
IP20 • 19199 • 19200
silver/purple



5 998250 340203

4062 (MP)

☒ E27 / 1x max. 100W +
E14 / 1x max. 25W
IP20 • 9871 • 9872
black/white



5 998250 340623

4064 (MP)

☒ E27 / 1x max. 100W +
E14 / 1x max. 25W
IP20 • 9871 • 9872
satin chrome/white



5 998250 340647

4065 (MP)

☒ E27 / 1x max. 100W +
E14 / 1x max. 25W
IP20 • 9871 • 9872
bronze/white



5 998250 340654

4188 (MP)

☒ E27 / 1x max. 100W +
E14 / 1x max. 25W
IP20 • 9871 • 9872
brown/white



5 998250 341880



FABIAN

WOOD

OTHERS / BEST MATCH 114-115.

NEW



5245 (M)

☒ E27 / 1x max. 40W
IP20 • []
matte black/beech



5 998250 352459

5246 (M)

☒ E27 / 2x max. 40W
IP20 • []
matte black/beech



5 998250 352466

LANNY

OTHERS / BEST MATCH 126-127.



4560

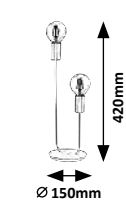

4560 (M)

☒ E27 / 2x max. 15W
IP20 • []
black/gold



5 998250 345604

4561

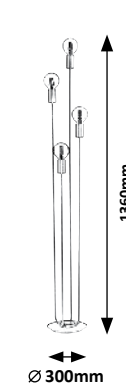

4561 (M)

☒ E27 / 4x max. 15W
IP20 • []
black/gold



5 998250 345611



BASIL

GODRIC

THOMAS

YVETTE

OTHERS / BEST MATCH 290-291.

NEW

WOOD TEXTILE CABLE

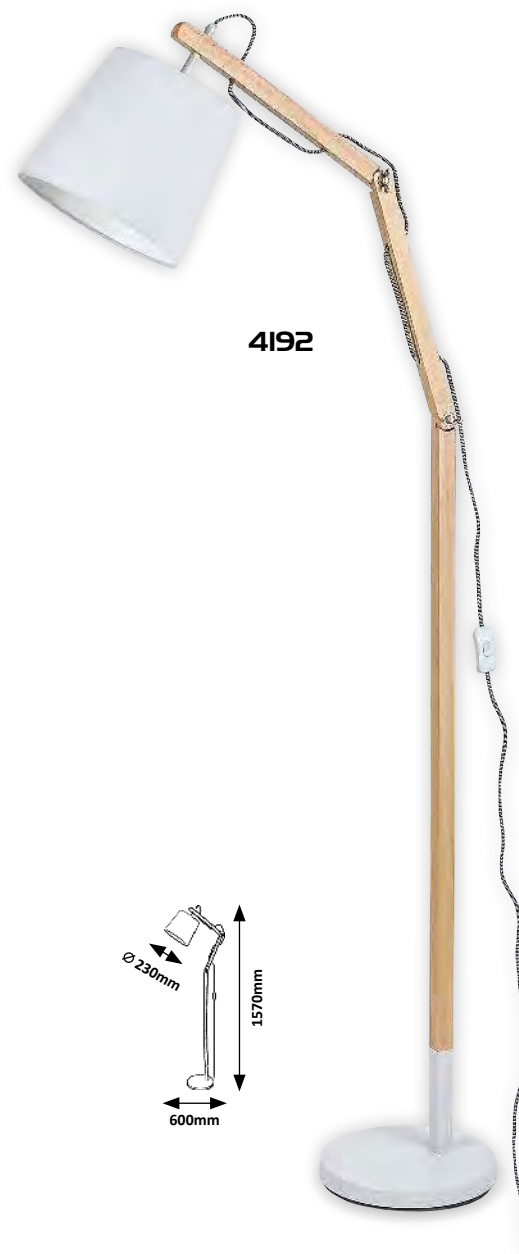
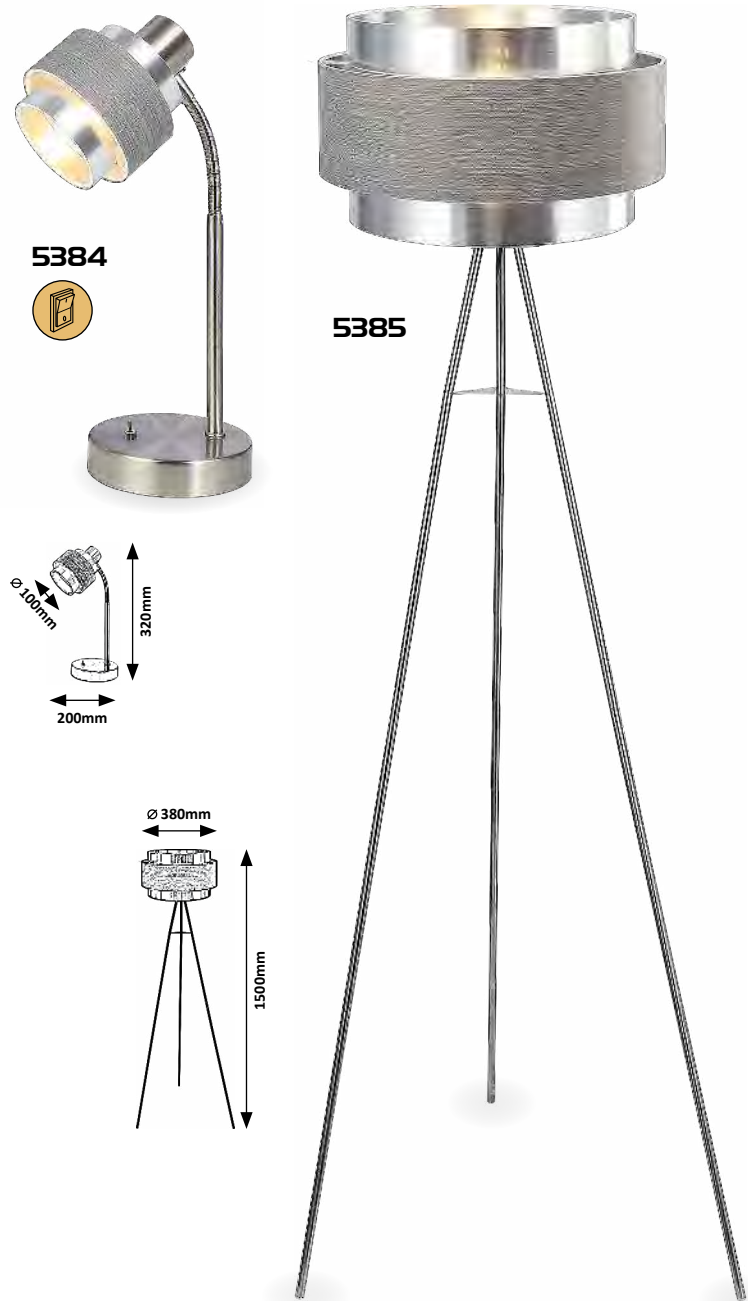

5384 (M) (P)

⊗ E14 / 1x max. 10W
IP20 • □
▲ 19795
satin chrome/silver oak



5 998250 353845

5385 (M) (P)

⊗ E27 / 1x max. 40W
IP20 • □
▲ 19797
satin chrome/silver oak



5 998250 353852

6639 (M) (T)

⊗ E27 / 1x max. 25W
IP20 • □
▲ 19982
black/grey



5 998250 366395

6640 (M) (T)

⊗ E27 / 1x max. 25W
IP20 • □
▲ 19979
black



5 998250 366401

4192 (W) (T)

⊗ E27 / 1x max. 60W
IP20 • □
▲ 19455
beech/white



5 998250 341927

4370 (C) (T)

⊗ E14 / 1x max. 40W
IP20 • □
▲ 19382
beige/white



5 998250 343709

BLANKA

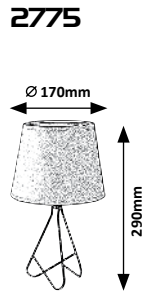
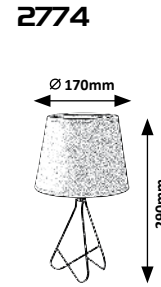

KINGA

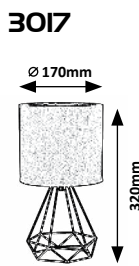
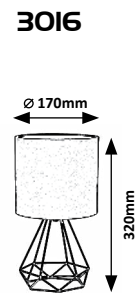

2774 (M) (T)

☒ E14 / 1x max. 40W
IP20 •
▲ 19892
black/rose gold



5 998250 327747

2775 (M) (T)

☒ E14 / 1x max. 40W
IP20 •
▲ 19893
grey/chrome



5 998250 327754

3016 (M) (T)

☒ E14 / 1x max. 40W
IP20 •
▲ 19655
black



5 998250 330167

3017 (M) (T)

☒ E14 / 1x max. 40W
IP20 •
▲ 19656
brown/gold



5 998250 330174

NALANI

VELVET OTHERS / BEST MATCH 75.

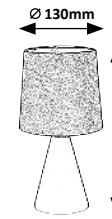
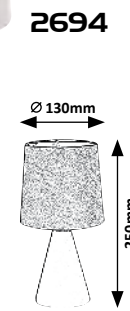
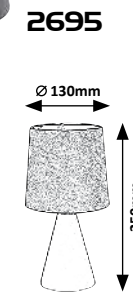

2694 (C) (T)

☒ E14 / 1x max. 40W
IP20 •
▲ 19899
beige



5 998250 326948

2695 (C) (T)

☒ E14 / 1x max. 40W
IP20 •
▲ 19900
grey



5 998250 326955

2696 (C) (T)

☒ E14 / 1x max. 40W
IP20 •
▲ 19901
blue



5 998250 326962

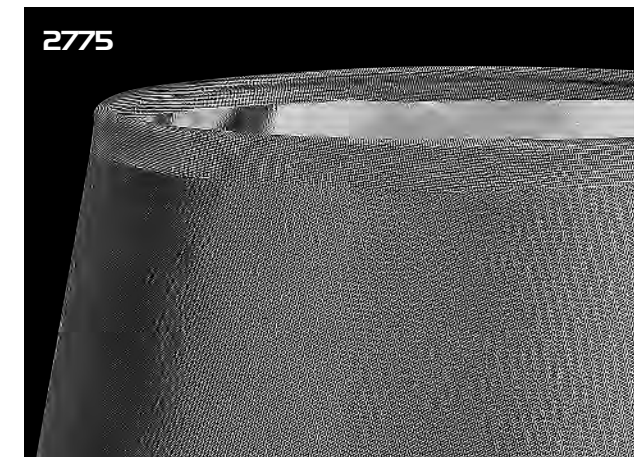

WENDY

NEW



5220

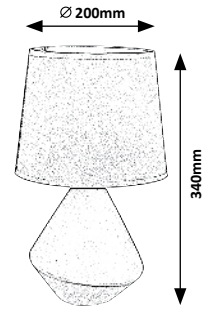

5221

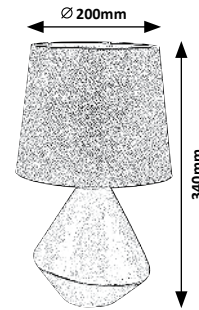

AMIEL



5703

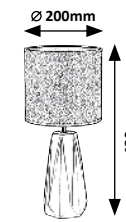

5704

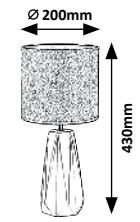

GALEN



5509

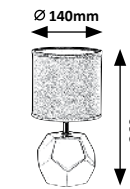

5510

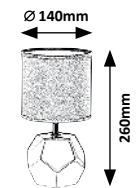

5220 (CT)

E14 / 1x max. 40W
IP20 • 19941
grey



5 998250 352206

5221 (CT)

E14 / 1x max. 40W
IP20 • 19942
brown



5 998250 352213



5703 (CT)

E27 / 1x max. 60W
IP20 • 19766
green



5 998250 357034

5704 (CT)

E27 / 1x max. 60W
IP20 • 19767
brown



5 998250 357041

5509 (CT)

E14 / 1x max. 40W
IP20 • 19764
grey



5 998250 355092

5510 (CT)

E14 / 1x max. 40W
IP20 • 19765
brown



5 998250 355108



OTHERS / BEST MATCH 186.

GINGER



6029

6030

Ø 250mm

Ø 250mm

490mm

490mm

EVELYN



4372

4390

Ø 200mm

Ø 280mm

380mm

590mm

SALEM



4948

4949

4950

Ø 180mm

Ø 180mm

Ø 180mm

250mm

250mm

250mm

SONAL



4548

4549

Ø 180mm

Ø 180mm

300mm

300mm

6029 C T

☒ E27 / 1x max. 60W
IP20 • □
▲ 19768
white/silver/grey



5 998250 360294

6030 C T

☒ E27 / 1x max. 60W
IP20 • □
▲ 19769
white/gold/brown



5 998250 360300

4372 C T

☒ E14 / 1x max. 40W
IP20 • □
▲ 19383
chrome/black



5 998250 343723

4390 C T

☒ E27 / 1x max. 40W
IP20 • □
▲ 19469
silver/black



5 998250 343907

4948 C T

☒ E14 / 1x max. 40W
IP20 • □
▲ 19165
white/grey



5 998250 349480

4949 C T

☒ E14 / 1x max. 40W
IP20 • □
▲ 19157
white/silver



5 998250 349497

4950 C T

☒ E14 / 1x max. 40W
IP20 • □
▲ 19160
black/silver



5 998250 349503

4548 C T

☒ E14 / 1x max. 40W
IP20 • □
▲ 19807
silver/white



5 998250 345482

4549 C T

☒ E14 / 1x max. 40W
IP20 • □
▲ 19808
gold/black



5 998250 345499

ORLANDO



ELLIE

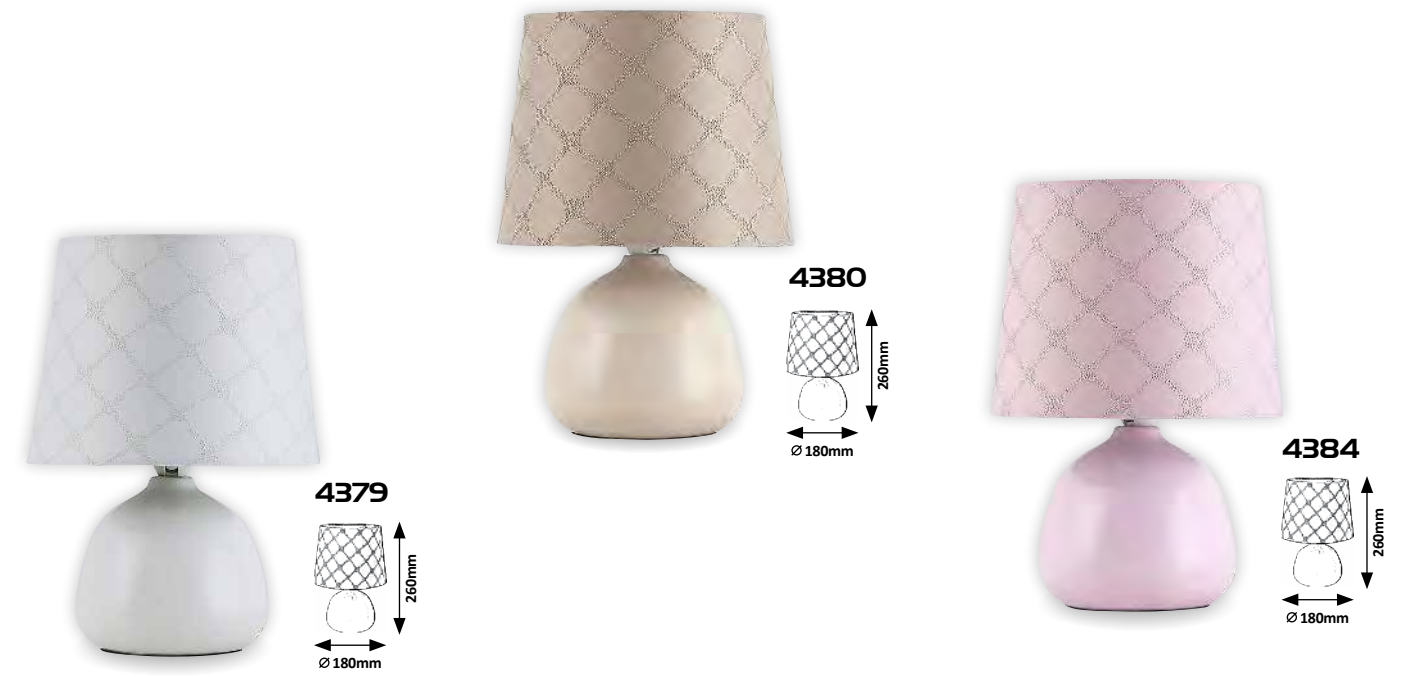

MOLLY



4458 C T

☒ E14 / 1x max. 40W
IP20 •
▲ 19424
grey



5 998250 344584

4928 C T

☒ E14 / 1x max. 40W
IP20 •
▲ 19164
wenge/white



5 998250 349282

4929 C T

☒ E14 / 1x max. 40W
IP20 •
▲ 19164
cream/white



5 998250 349299

4930 C T

☒ E14 / 1x max. 40W
IP20 •
▲ 19164
cocoa/white



5 998250 349305

4379 C T

☒ E14 / 1x max. 40W
IP20 •
▲ 19458
white



5 998250 343792

4380 C T

☒ E14 / 1x max. 40W
IP20 •
▲ 19459
beige



5 998250 343808

4384 C T

☒ E14 / 1x max. 40W
IP20 •
▲ 19463
rose



5 998250 343846

4391 C T

☒ E14 / 1x max. 40W
IP20 •
▲ 19470
beige/white



5 998250 343914

4392 C T

☒ E14 / 1x max. 40W
IP20 •
▲ 19470
blue/white



5 998250 343921

INGRID



4476
 280mm
 Ø 170mm



4478
 280mm
 Ø 170mm



4475
 280mm
 Ø 170mm



4477
 280mm
 Ø 170mm

4475 C T

⊗ E14 / 1x max. 40W
 IP20 •
 ▲ 19534
 cream



5 998250 344751

4476 C T

⊗ E14 / 1x max. 40W
 IP20 •
 ▲ 19605
 brown



5 998250 344768

4477 C T

⊗ E14 / 1x max. 40W
 IP20 •
 ▲ 19535
 green



5 998250 344775

4478 C T

⊗ E14 / 1x max. 40W
 IP20 •
 ▲ 19536
 claret



5 998250 344782

ARIEL



4901
 190mm
 Ø 200mm



4904
 190mm
 Ø 200mm



4906
 190mm
 Ø 200mm



4907
 190mm
 Ø 200mm



4901 C T

⊗ E14 / 1x max. 40W
 IP20 •
 ▲ 9910
 matte white



5 998250 349015

4904 C T

⊗ E14 / 1x max. 40W
 IP20 •
 ▲ 9912
 orange



5 998250 349046

4906 C T

⊗ E14 / 1x max. 40W
 IP20 •
 ▲ 9914
 cherry



5 998250 349066

4907 C T

⊗ E14 / 1x max. 40W
 IP20 •
 ▲ 9915
 green



5 998250 349077

DORA

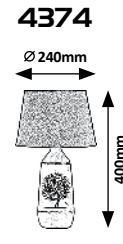
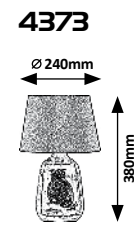

DORKA

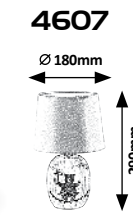
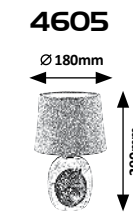

PETRA

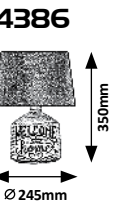

SOPHIE

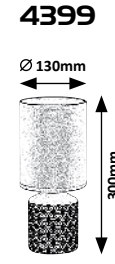
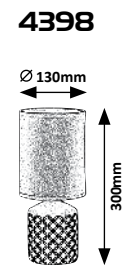
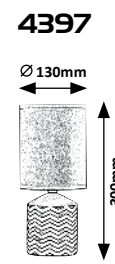

4373 C T

☒ E27 / 1x max. 40W
IP20 • ☒
▲ 19384
white/grey



4374 C T

☒ E27 / 1x max. 40W
IP20 • ☒
▲ 19384
white/grey



4397 C T

☒ E14 / 1x max. 40W
IP20 • ☒
▲ 19547
white/grey



4398 C T

☒ E14 / 1x max. 40W
IP20 • ☒
▲ 19547
white/black



4399 C T

☒ E14 / 1x max. 40W
IP20 • ☒
▲ 19547
white/green



4605 C T

☒ E14 / 1x max. 40W
IP20 • ☒
▲ 19550
brown



4607 C T

☒ E14 / 1x max. 40W
IP20 • ☒
▲ 19551
grey



4386 C T

☒ E14 / 1x max. 40W
IP20 • ☒
▲ 19465
beige/grey





NEW

GREMIO

6915

NEW

BOOGIE

3180

3179

OTHERS / BEST MATCH 119.

BOWIE

6569

6570

TEXTILE CABLE OTHERS / BEST MATCH 102-103. **NEW**

DIMITRI

3124



6915 **M**
 ☒ E27 / 1x max. 40W
 IP20 • •
 beech/black

5 998250 369150

3179 **M**
 ☒ E14 / 1x max. 25W
 IP20 • •
 gold/white

5 998250 331799

3180 **M**
 ☒ E14 / 1x max. 25W
 IP20 • •
 beech/black

5 998250 331805

6569 **M**
 ☒ E27 / 1x max. 60W
 IP20 • •
 black

5 998250 365695

6570 **M**
 ☒ E27 / 1x max. 60W
 IP20 • •
 white

5 998250 365701

3124 **M**
 ☒ E27 / 1x max. 40W
 IP20 • •
 black

5 998250 331249

ZELKOVA



OTHERS / BEST MATCH

16.

NEW



3153

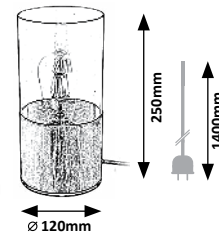

TRUDY



6383

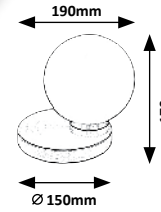

RONNIE

NEW



5254

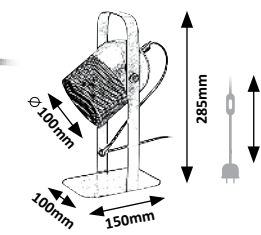

5255

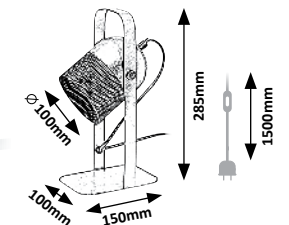

3153



E27 / 1x max. 40W
IP20 • 19952
brushed aluminium/transparent



5 998250 331539

6383



LED 5W
(400lm, 3000K) incl.
IP20 • 19802 • 19802
satin chrome/white



5 998250 363837

5254



E14 / 1x max. 25W
IP20 • 35254
grey/gold



5 998250 352541

5255



E14 / 1x max. 25W
IP20 • 35255
beige/gold



5 998250 352558

THEODOR

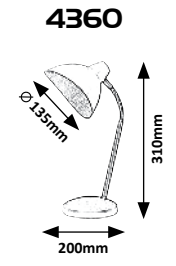

NEW

MONTY

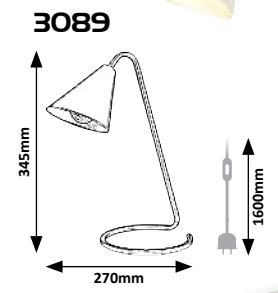
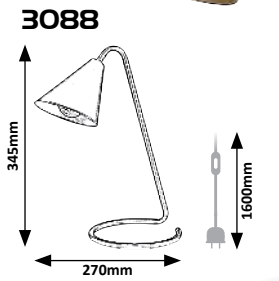

FANNY

NEW

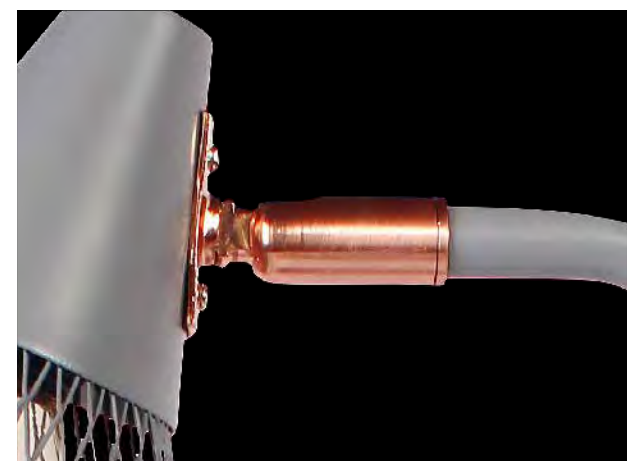
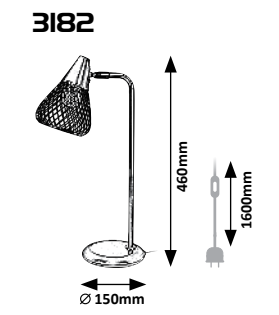
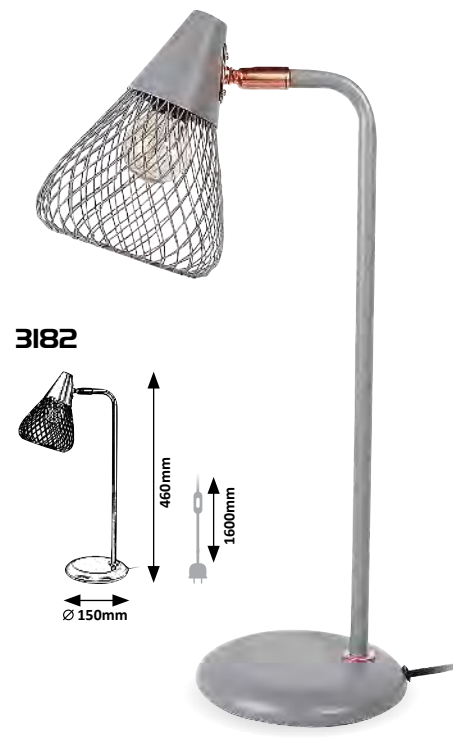
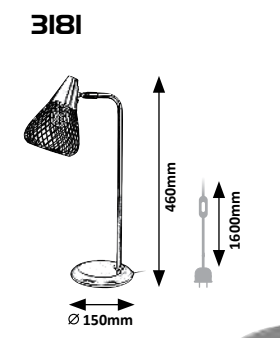

4360 (M)
 E14 / 1x max. 25W
 IP20 •
 black/gold



3088 (M)
 E14 / 1x max. 40W
 IP20 •
 black



3089 (M)
 E14 / 1x max. 40W
 IP20 •
 white



3181 (M)
 E14 / 1x max. 25W
 IP20 •
 black/gold



3182 (M)
 E14 / 1x max. 25W
 IP20 •
 grey/rose gold





AKSEL

WOOD OTHERS / BEST MATCH 159.

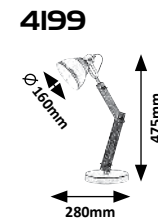

NICOLAS

WOOD OTHERS / BEST MATCH 156.

NEW

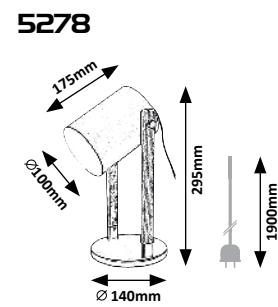

4199 WM

☒ E14 / 1x max. 15W
IP20 • ☒
anthracite/beech



5278 MW

☒ E27 / G45 / 1x max. 9W
IP20 • ☒
matte black/beech



RUFIN

OTHERS / BEST MATCH 122. NEW

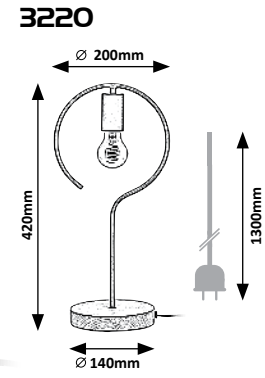
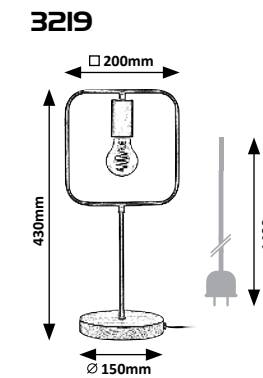

3219 M

☒ E27 / 1x max. 40W
IP20 • ☒
beech/black



3220 M

☒ E27 / 1x max. 40W
IP20 • ☒
beech/black



BANK

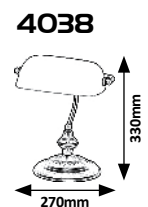
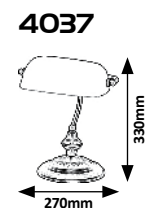

CARTER

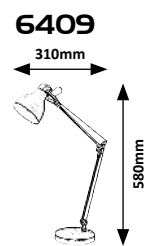

4037 M G

☒ E27 / 1x max. 60W
IP20 •
▲ 9586

satin chrome/white



5 998250 340371

4038 M G

☒ E27 / 1x max. 60W
IP20 •
▲ 9587

bronze/green



5 998250 340388

6408 M

☒ E14 / 1x max. 11W
IP20 •
matte black



5 998250 364087

6409 M

☒ E14 / 1x max. 11W
IP20 •
mint/brown



5 998250 364094

6410 M

☒ E14 / 1x max. 11W
IP20 •
beige/brown



5 998250 364100

SAMSON

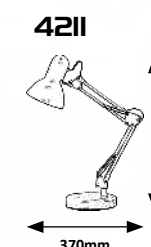
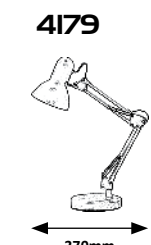
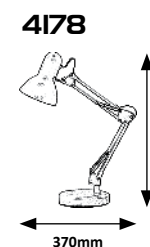

4178 M

☒ E27 / 1x max. 60W
IP20 •
green



5 998250 341781

4179 M

☒ E27 / 1x max. 60W
IP20 •
rose



5 998250 341798

4211 M

☒ E27 / 1x max. 60W
IP20 •
white



5 998250 342115

4212 M

☒ E27 / 1x max. 60W
IP20 •
black



5 998250 342122

4213 M

☒ E27 / 1x max. 60W
IP20 •
silver



5 998250 342139

ARNO



RAUL



COLIN

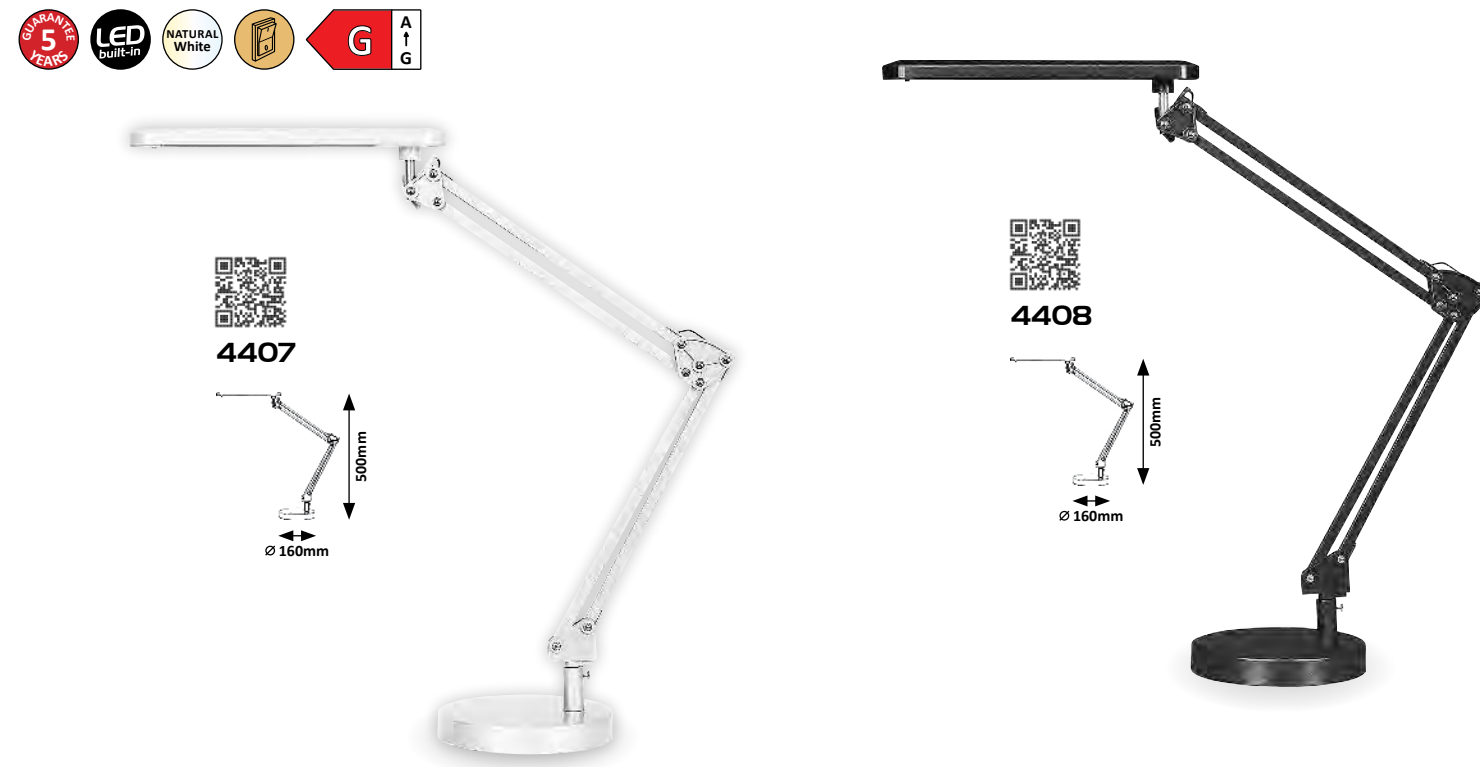

RONALD



4214 (M)
 E27 / 1x max. 60W
 IP20 •
 white



5 998250 342146

4215 (M)
 E27 / 1x max. 60W
 IP20 •
 black



5 998250 342153

4216 (M)
 E27 / 1x max. 60W
 IP20 •
 silver



5 998250 342160

4407 (M P)
 LED / 6W
 (350lm, 4500K) incl.
 IP20 •
 white



5 998250 344072

4408 (M P)
 LED / 6W
 (350lm, 4500K) incl.
 IP20 •
 black



5 998250 344089

4419 (M P)
 LED / 6W
 (350lm, 4500K) incl.
 IP20 •
 black



5 998250 344195

4420 (M P)
 LED / 6W
 (350lm, 4500K) incl.
 IP20 •
 silver



5 998250 344201

4334 (P)
 LED / 5W
 (350lm, 6400K) incl.
 IP20 •
 black



5 998250 343341

4335 (P)
 LED / 5W
 (350lm, 6400K) incl.
 IP20 •
 silver



5 998250 343358

CLARK

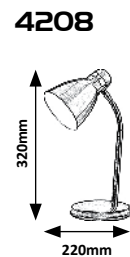
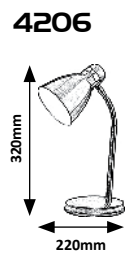
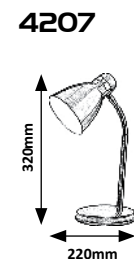
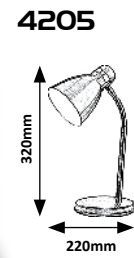
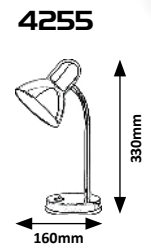

PATRIC

DYLAN

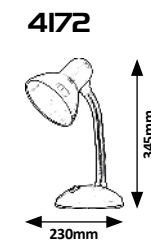
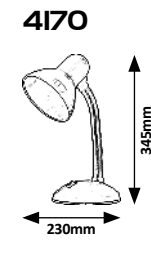
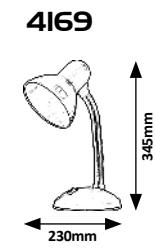
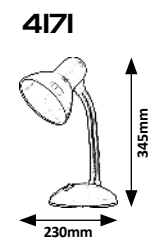
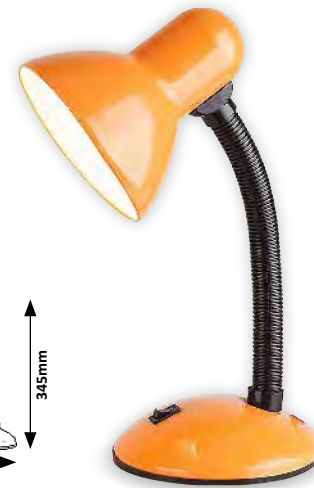
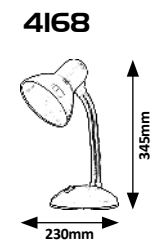

4255 **M**
 ☒ E27 / 1x max. 40W
 IP20 • chrome



4205 **M**
 ☒ E14 / 1x max. 40W
 IP20 • white/chrome



4206 **M**
 ☒ E14 / 1x max. 40W
 IP20 • silver/chrome



4207 **M**
 ☒ E14 / 1x max. 40W
 IP20 • blue/chrome



4208 **M**
 ☒ E14 / 1x max. 40W
 IP20 • green/chrome



4168 **M**
 ☒ E27 / 1x max. 40W
 IP20 • white/black



4169 **M**
 ☒ E27 / 1x max. 40W
 IP20 • black



4170 **M**
 ☒ E27 / 1x max. 40W
 IP20 • green/black



4171 **M**
 ☒ E27 / 1x max. 40W
 IP20 • orange/black



4172 **M**
 ☒ E27 / 1x max. 40W
 IP20 • rose/black





LIONEL

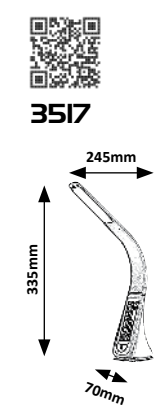
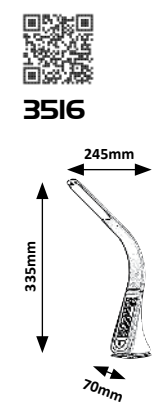
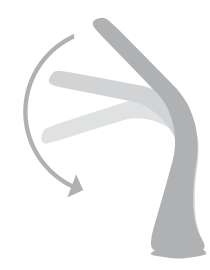

3516 (P)
 LED / 5W
 (260lm, 5000K) incl.
 IP20 • 5V/1A (DC) incl. •
 white

 5 998250 335162

3517 (P)
 LED / 5W
 (260lm, 5000K) incl.
 IP20 • 5V/1A (DC) incl. •
 black

 5 998250 335179

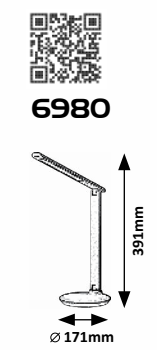
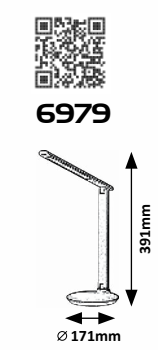
OSIAS



6979 (P)
 LED / 9W
 (400lm, 2700K-6500K) incl.
 IP20 •
 white

 5 998250 369792

6980 (P)
 LED / 9W
 (400lm, 2700K-6500K) incl.
 IP20 •
 black

 5 998250 369808

One button = Three functions Egy gomb = három funkció • Ein Boden = Drei Funktionen



Quick Touch = ON/OFF
 Rövid Érintés = Be-/kikapcsolás • Schnelle Berührung = Ein/Aus



Quick Touch = Colour Temperature Changing
 Rövid érintés = Színhőmérséklet változtatás • Schnelle Berührung = Änderung der Farbtemperatur



Long Touch = Dimming
 Hosszú érintés = Fényerő szabályozás • Lange Berührung = Dimmen

3349, 3350



1515



2977



M

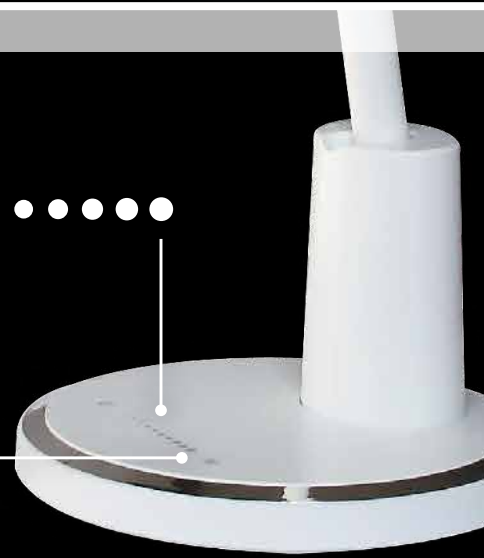

3349 M P

LED / 7W
(400lm, 4000K) incl.
IP20 • silver/white



5 998250 333496

MISHA

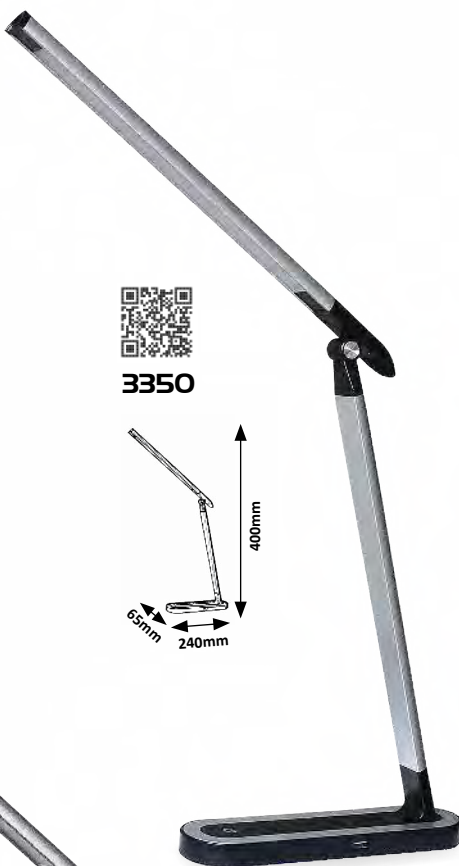

3350

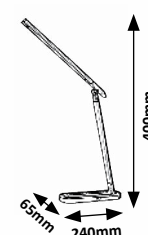

3349

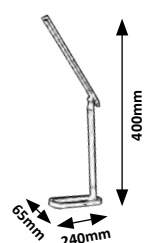

3350 M P

LED / 7W
(400lm, 4000K) incl.
IP20 • silver/black



5 998250 333502

TEKLA



2977



2977 M P

LED / 10W
(700lm, 3000K-6000K) incl.
IP20 • white



5 998250 329772

JUSTIN

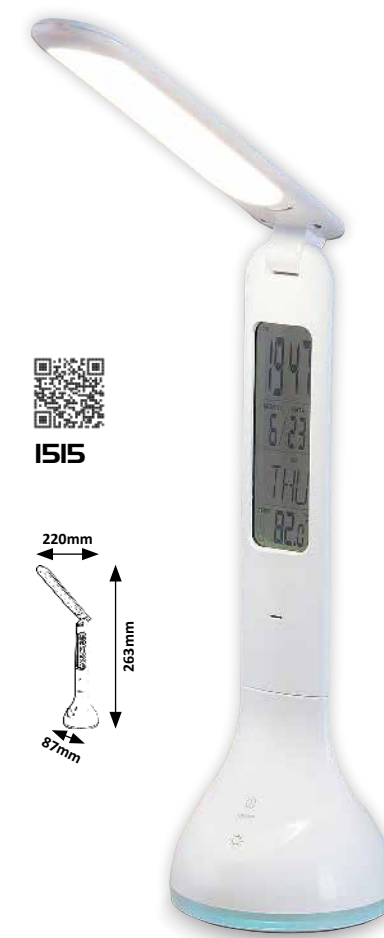

1515

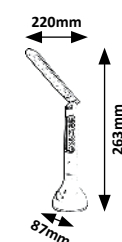

1515 P

LED / 4W
(253lm, 4000K) incl.
IP20 • DC 5V incl. • white



5 998250 315157



BELMONT

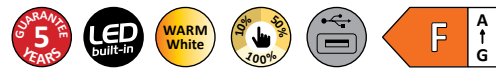

DOMINIC



TIMOTHY



One button = Two functions

Egy gomb = kettő funkció • Ein Boden = Zwei Funktionen



Quick Touch = ON

Rövid érintés = Bekapcsolás • Schnelle Berührung = EIN

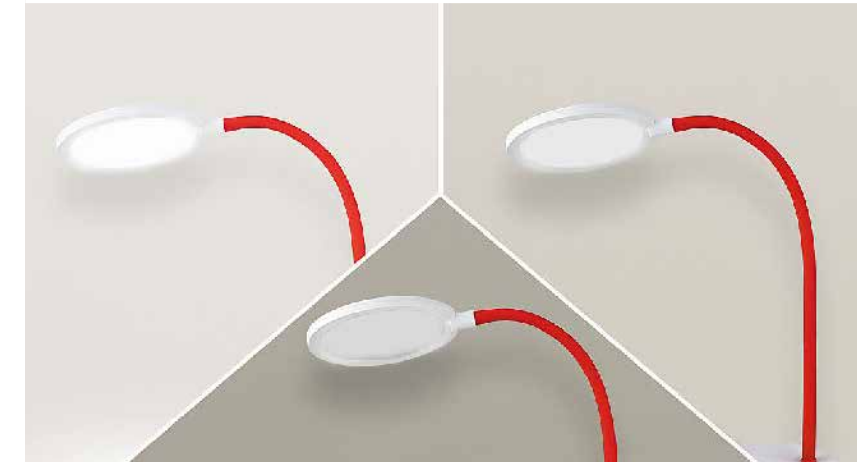

Long Touch = Dimming

Hosszú érintés = Fényerő szabályozás • Lange Berührung = Dimmen



Quick Touch = Off

Rövid érintés = Kikapcsolás • Schnelle Berührung = AUS

6418 (P)

LED / 5W
(400lm, 3000K) incl.
IP20 • white



5 998250 364186

6419 (P)

LED / 5W
(400lm, 3000K) incl.
IP20 • grey



5 998250 364193

6420 (P)

LED / 5W
(400lm, 3000K) incl.
IP20 • gold



5 998250 364209

4164 (P)

LED / 5,3W
(520lm, 3000K) incl.
IP20 • black



5 998250 341644

4167 (P)

LED / 5,3W
(520lm, 3000K) incl.
IP20 • champagne



5 998250 341675

5429 (M P)

LED / 7,5W
(440lm, 4000K) incl.
IP20 • black/white



5 998250 354293

5430 (M P)

LED / 7,5W
(440lm, 4000K) incl.
IP20 • red/white



5 998250 354309



BALOR



3958 (P)
 LED / 5W
 (320lm, 4000K) incl.
 IP20 •
 black/white

 5 998250 339580

3959 (P)
 LED / 5W
 (320lm, 4000K) incl.
 IP20 •
 brown/white

 5 998250 339597

BERRY



6778 (M)
 LED / 4,5W
 (350lm, 4000K) incl.
 IP20 •
 white

 5 998250 367781

6779 (M)
 LED / 4,5W
 (350lm, 4000K) incl.
 IP20 •
 rose

 5 998250 367798

6780 (M)
 LED / 4,5W
 (350lm, 4000K) incl.
 IP20 •
 blue

 5 998250 367804

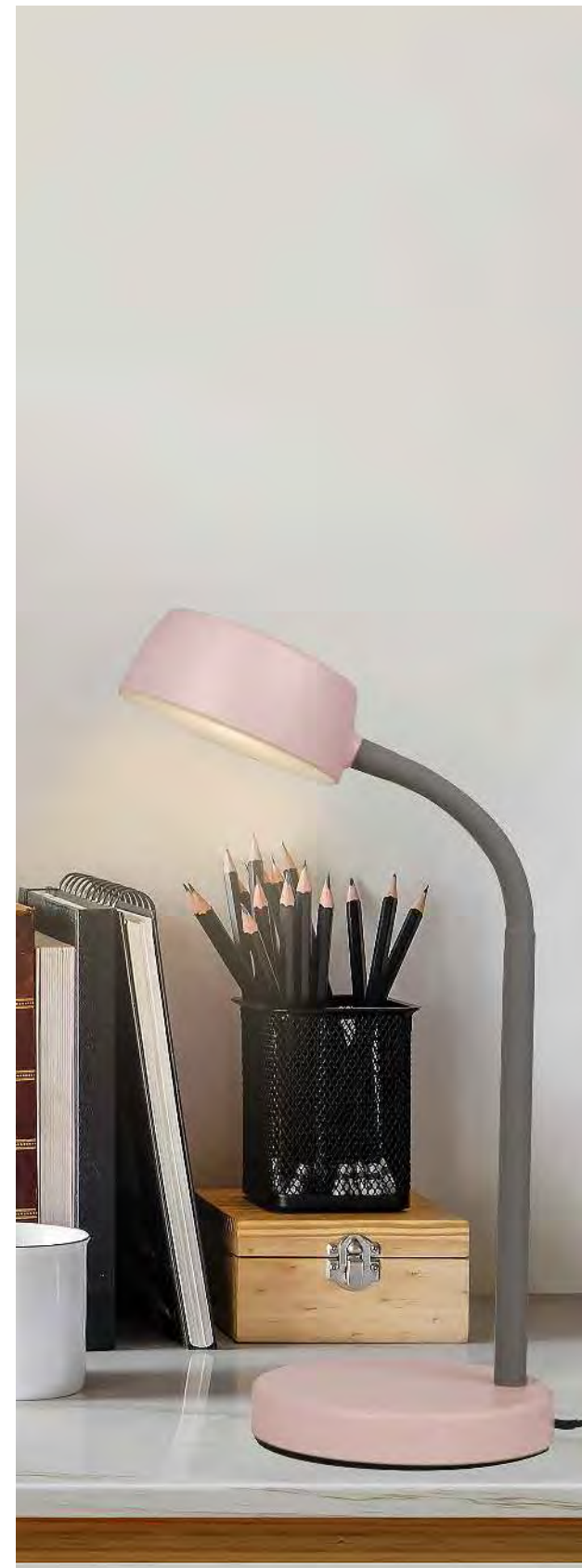

JEFF



- | | | | |
|---|--|--|---|
| <p>4195 (P)</p> <p>LED / 4,5W
(330lm, 3000K) incl.
IP20 • </p> <p>blue</p> <p>5 998250 341958</p> | <p>4196 (P)</p> <p>LED / 4,5W
(330lm, 3000K) incl.
IP20 • </p> <p>white</p> <p>5 998250 341965</p> | <p>4197 (P)</p> <p>LED / 4,5W
(330lm, 3000K) incl.
IP20 • </p> <p>black</p> <p>5 998250 341972</p> | <p>4198 (P)</p> <p>LED / 4,5W
(330lm, 3000K) incl.
IP20 • </p> <p>claret</p> <p>5 998250 341989</p> |
|---|--|--|---|

NOAH



- | | | | | | |
|--|--|---|---|--|---|
| <p>1477 (M P)</p> <p>LED / 5W
(360lm, 3000K) incl.
IP20 • </p> <p>white</p> <p>5 998250 314776</p> | <p>1478 (M P)</p> <p>LED / 5W
(360lm, 3000K) incl.
IP20 • </p> <p>black</p> <p>5 998250 314785</p> | <p>1479 (M P)</p> <p>LED / 5W
(360lm, 3000K) incl.
IP20 • </p> <p>blue</p> <p>5 998250 314792</p> | <p>1480 (M P)</p> <p>LED / 5W
(360lm, 3000K) incl.
IP20 • </p> <p>grey</p> <p>5 998250 314808</p> | <p>1481 (M P)</p> <p>LED / 5W
(360lm, 3000K) incl.
IP20 • </p> <p>green</p> <p>5 998250 314815</p> | <p>1482 (M P)</p> <p>LED / 5W
(360lm, 3000K) incl.
IP20 • </p> <p>rose</p> <p>5 998250 314822</p> |
|--|--|---|---|--|---|

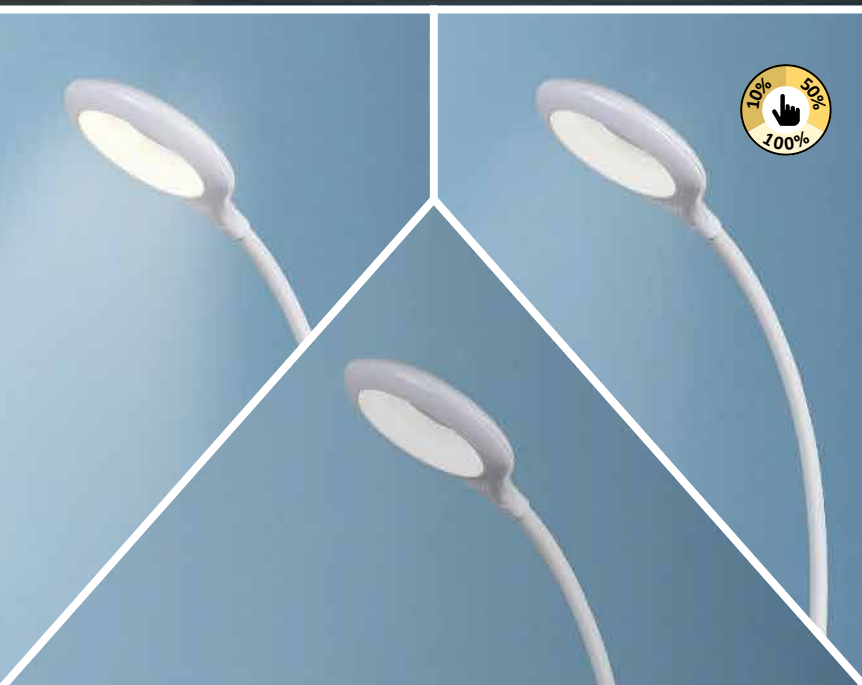

HARRIS

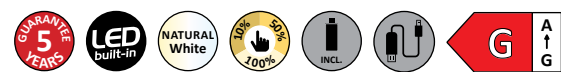

6448

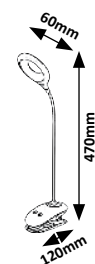

6448 (P)

LED / 4W
(180lm, 4000K) incl.
IP20 • DC 3,5V incl. • white



5 998250 364483

FLINT

NEW



3092

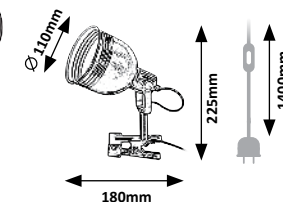

3093

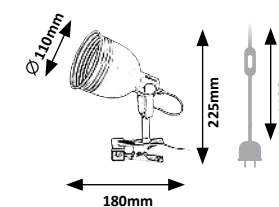

3092 (M)

E14 / 1x max. 25W
IP20 • black/white



5 998250 330921

3093 (M)

E14 / 1x max. 25W
IP20 • beige/white



5 998250 330938

CLIP



4356 (P)
 ☒ E14 / R50 / 1x max. 40W
 IP20 • •
 white



5 998250 343563

4357 (P)
 ☒ E14 / R50 / 1x max. 40W
 IP20 • •
 black



5 998250 343570

4359 (P)
 ☒ E14 / R50 / 1x max. 40W
 IP20 • •
 rose



5 998250 343594

DENNIS



4257 (M P)
 ☒ E27 / 1x max. 40W
 IP20 • •
 green/black



5 998250 342573

4258 (M P)
 ☒ E27 / 1x max. 40W
 IP20 • •
 orange/black



5 998250 342580

4259 (M P)
 ☒ E27 / 1x max. 40W
 IP20 • •
 rose/black



5 998250 342597

4260 (M P)
 ☒ E27 / 1x max. 40W
 IP20 • •
 blue/black



5 998250 342603



09

**CHILDREN AND
DECORATIVE
LAMPS**

**GYERMEK ÉS
DEKOR LÁMPÁK**

**KINDER- UND
DEKORLEUCHTEN**





BIRDY

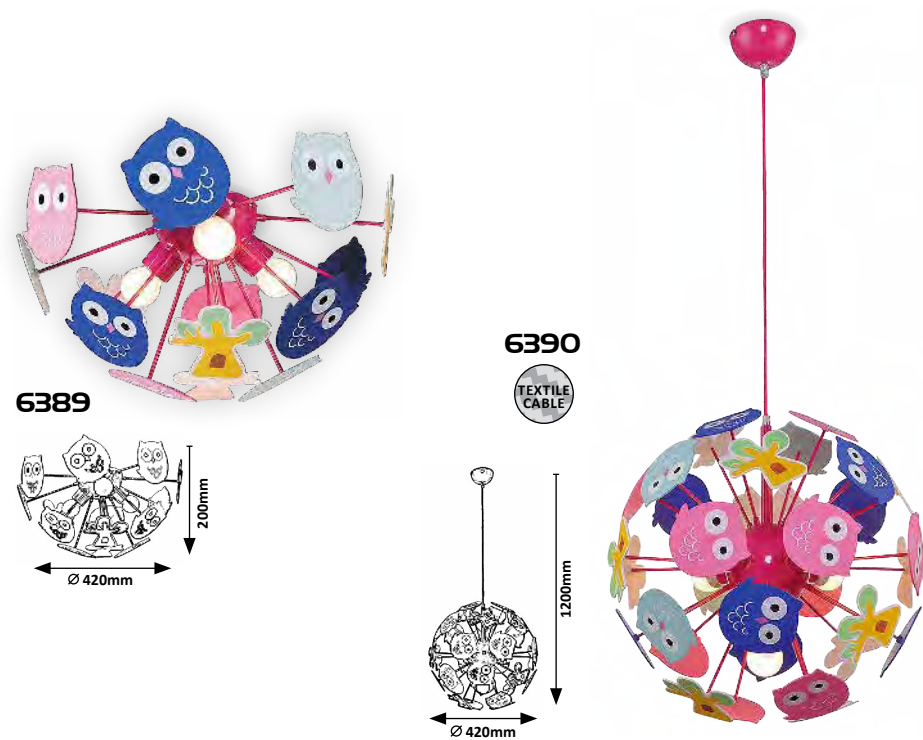

ABC

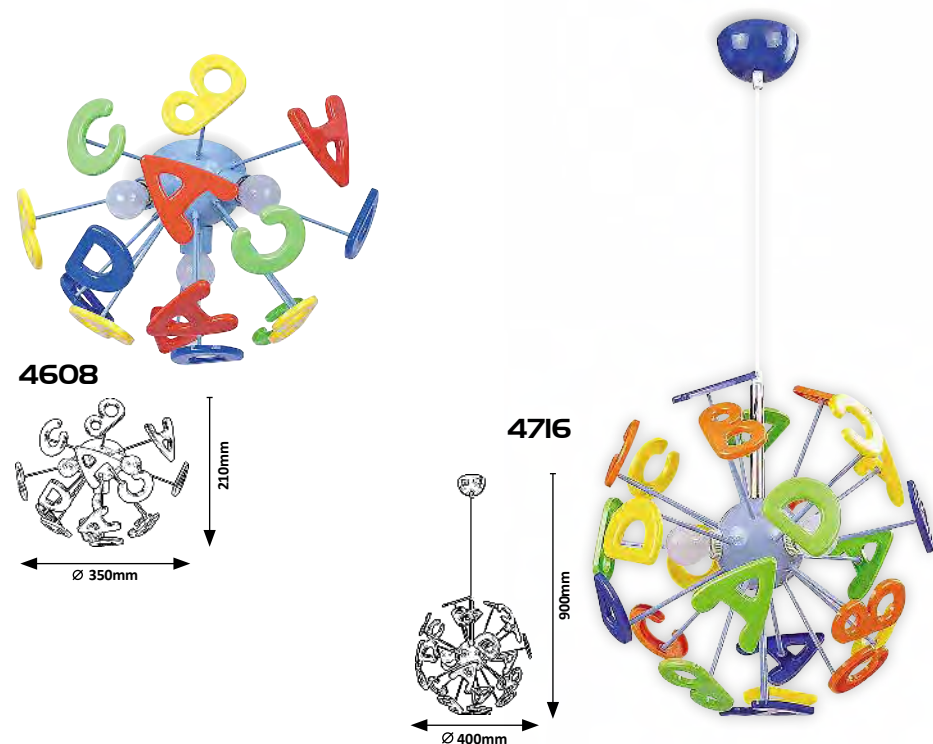

LINETT

DESIGNED BY **rabalux**

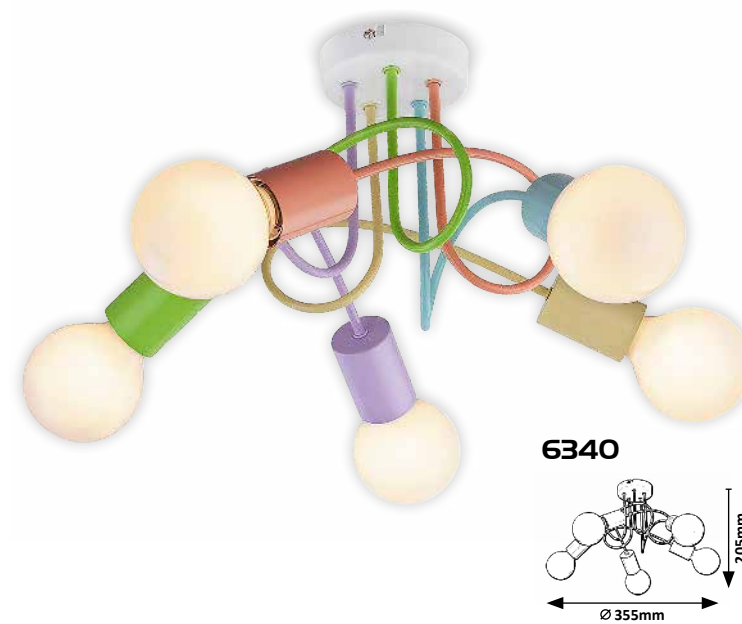

BEE

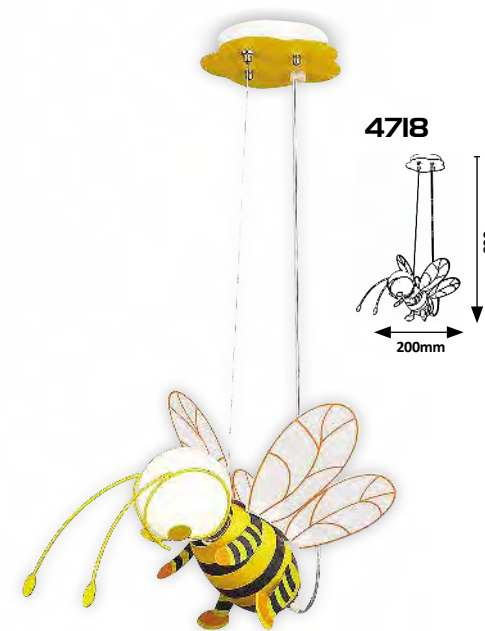

HELICOPTER

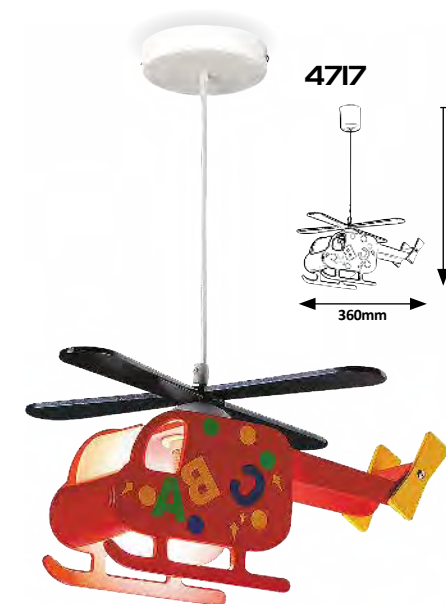

6389 (M) (P)

⊠ E14 / 3x max. 40W
IP20
multicolour



5 998250 363899

6390 (M) (P)

⊠ E14 / 3x max. 40W
IP20
multicolour



5 998250 363905

4608 (M) (P)

⊠ E14 / 3x max. 40W
IP20
multicolour



5 998250 346083

4716 (M) (P)

⊠ E14 / 3x max. 40W
IP20
multicolour



5 998250 347165

4717 (P)

⊠ E27 / 1x max. 40W
IP20
multicolour



5 998250 347172

4718 (P)

⊠ E27 / G90 / 1x max. 40W
IP20
multicolour



5 998250 347189

6340 (M)

⊠ E27 / 5x max. 40W
IP20
multicolour



5 998250 363400

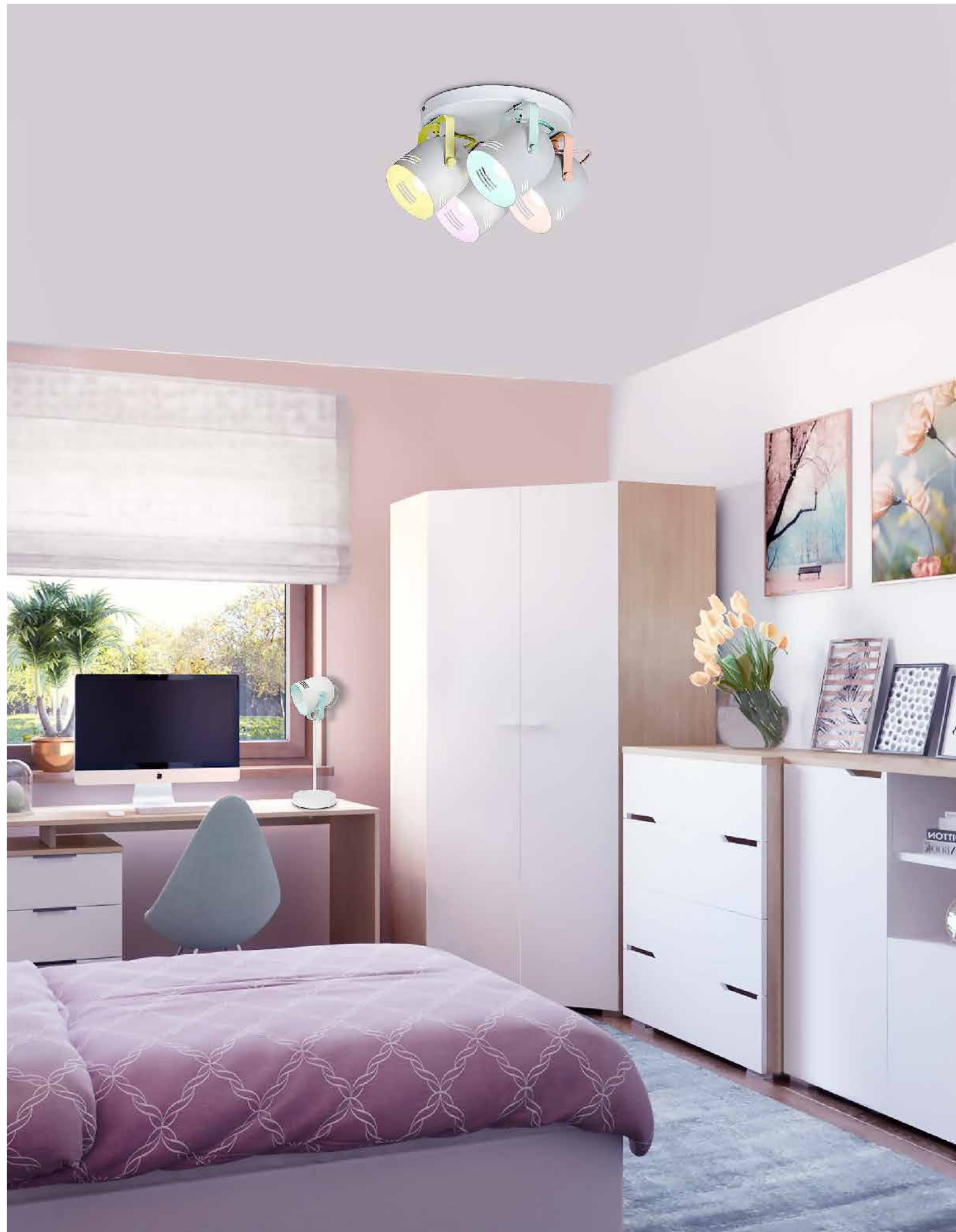

MINUET

TEXTILE CABLE
DESIGNED BY **rabalux**



7012

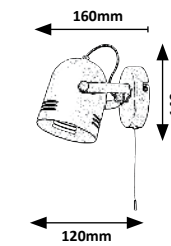

7013

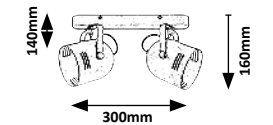

7014

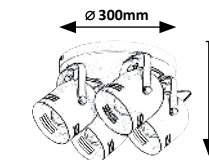

7015

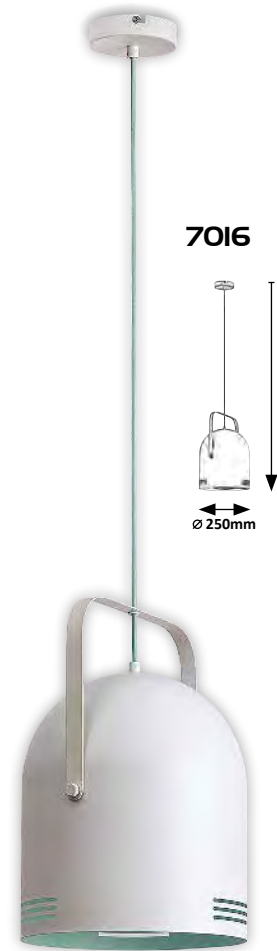
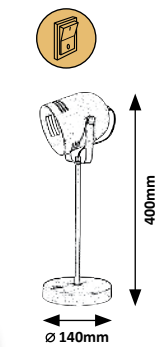

7016

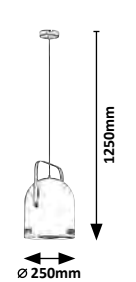

7012



☒ E14 / 1x max. 15W
IP20 •
white/mint



5 998250 370125

7013



☒ E14 / 2x max. 40W
IP20
multicolour



5 998250 370132

7014



☒ E14 / 4x max. 40W
IP20
multicolour



5 998250 370149

7015



☒ E14 / 1x max. 15W
IP20 •
white/mint



5 998250 370156

7016



☒ E27 / 1x max. 40W
IP20
white/mint



5 998250 370163

HANKA



3079

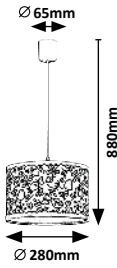

3080

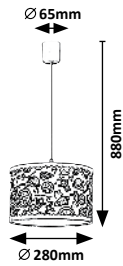

3416

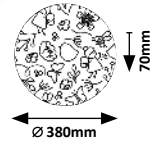

3417

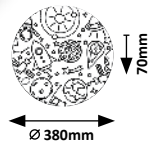

3079 P

⊠ E27 / 1x max. 40W
IP20
white/multicolour



5 998250 330792

3080 P

⊠ E27 / 1x max. 40W
IP20
white/multicolour



5 998250 330808

3416 MP

⊠ LED / 24W
(1560lm, 3000K) incl.
IP20 • 19810
white/multicolour



5 998250 334165

3417 MP

⊠ LED / 24W
(1560lm, 3000K) incl.
IP20 • 19811
white/multicolour



5 998250 334172



LEON

DESIGNED BY **rabalux**



4559

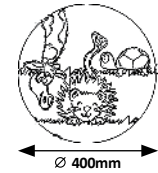

4565



OTHERS / BEST MATCH 442.

4633



4571

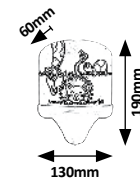

CATHY

DESIGNED BY **rabalux**

OTHERS / BEST MATCH 442.



4558

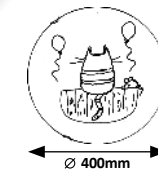

4564



4570



4632

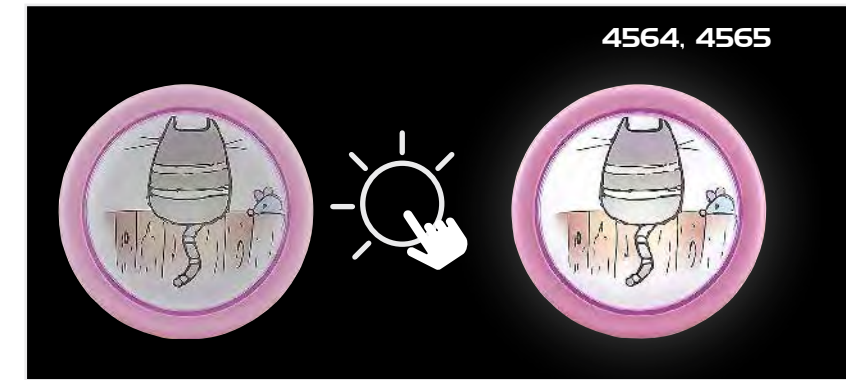

4564, 4565

4559 M G

E27 / 2x max. 60W
IP20 • 682
multicolour



5 998250 345596

4565 P

LED / 0,3W incl.
DC 3V • 2x AA excl.
IP20 • multicolour



5 998250 345659

4571 P

7W (18lm, 2700K) incl.
E14 / 1x max. 7W
IP20
multicolour



5 998250 345710

4633 M PA

multicolour



5 998250 346335

4558 M G

E27 / 2x max. 60W
IP20 • 681
multicolour



5 998250 345581

4564 P

LED / 0,3W incl.
DC 3V • 2x AA excl.
IP20 • multicolour



5 998250 345642

4570 P

7W (18lm, 2700K) incl.
E14 / 1x max. 7W
IP20
multicolour



5 998250 345703

4632 M PA

multicolour



5 998250 346328

SHEPHERD

DESIGNED BY **rabalux**

OTHERS / BEST MATCH 442.



4557 M G

⊠ E27 / 2x max. 60W
IP20 • 680
multicolour



5 998250 345574

4563 P

⊠ LED / 0,3W incl.
DC 3V • 2x AA excl.
IP20 • multicolour



5 998250 345635

4569 P

⊠ 7W (18lm, 2700K) incl.
E14 / 1x max. 7W
IP20
multicolour



5 998250 345697

4631 M PA

⊠ multicolour



5 998250 346311

RICE

OTHERS / BEST MATCH 442.

4894



4898



4894 M PA

⊠ white



5 998250 348940

4898 M PA

⊠ white



5 998250 348988

BALOO

LED built-in WARM White RGB LED INCL. SOFT TOUCH

5409

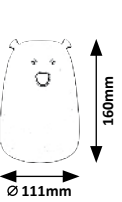

5410

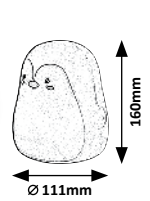

5409 SI

⊠ RGB LED / 0,4W
(29lm, 3000K) incl.
DC 5V incl.
IP20 • white



5 998250 354095

5410 SI

⊠ RGB LED / 0,4W
(29lm, 3000K) incl.
DC 5V incl.
IP20 • white



5 998250 354101

MILO



5730

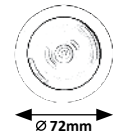

LUPE



6990

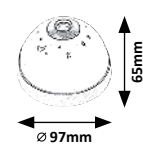

PUSH LIGHT



4703



MAGNUS



5675

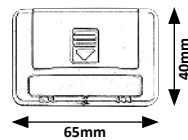

LINA

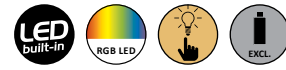

1470

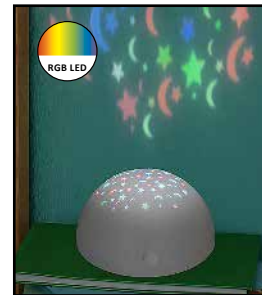

BILLY



4647

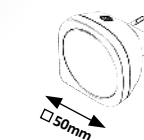

PARIS LUX



4658

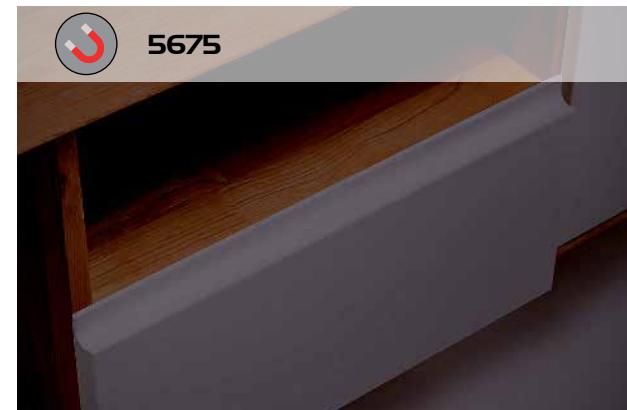
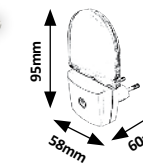

5730

P

LED / 0,5W
(30lm, 4000K) incl.
DC 4,5V • 3xAAA excl. • 2m, 120°
IP20 • white



5 998250 357300

5675

P

LED / 0,5W
(35lm, 3000K) incl.
DC 3V • 3xAA excl.
IP20 • white/transparent



5 998250 356754

6990

P

RGB LED / 0,5W (30lm) incl.
DC 3V • 3xAA excl.
IP20 • white



5 998250 369907

1470

P

RGB LED / 0,5W incl.
DC 4,5V • 3xAA excl.
IP20 • white



5 998250 314709

4703

P

LED / 0,3W incl.
DC 1,5V • 2xAA excl.
IP20 • white



5 998250 347035

4647

P

LED / 0,5W
(2lm, 2700K) incl.
IP20
white



5 998250 346472

4658

P

LED / 0,5W
(6lm, 4000K) incl.
IP20
white/transparent



5 998250 346588

MINKA

NEW



DESIGNED BY **rabalux**

7026

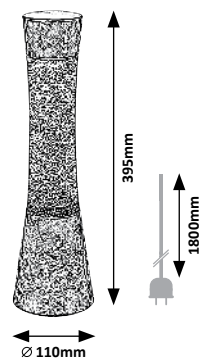

7028

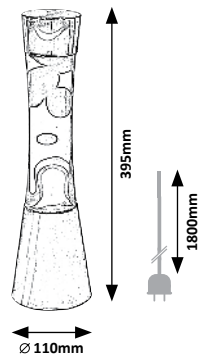

7030

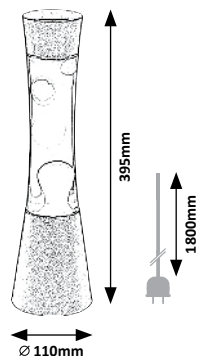

DESIGNED BY **rabalux**

7027

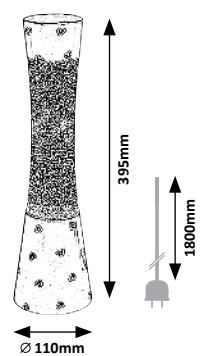

7029

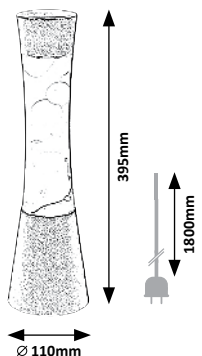

7026 M G

GY6.35 / 1x max. 20W
IP20 •
19450
blue/transparent



5 998250 370262

7027 M G

GY6.35 / 1x max. 20W
IP20 •
19450
rose/transparent



5 998250 370279

7028 M G

GY6.35 / 1x max. 20W
IP20 •
19450
multicolour/transparent



5 998250 370286

7029 M G

GY6.35 / 1x max. 20W
IP20 •
19450
silver/transparent



5 998250 370293

7030 M G

GY6.35 / 1x max. 20W
IP20 •
19450
silver/transparent



5 998250 370309



19450

EN: The spare lightsource can be used for warranty purposes only, it is not to be sold separately!

HU: A pótfényforrás csak garanciális célokra használható fel, önállóan nem értékesíthető!

DE: Die Ersatzlichtquelle kann nur für Garantiezwecke verwendet werden, sie sollte nicht einzeln verkauft werden!

6949



CARNIVAL



6949

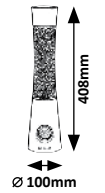

MARSHAL



4109



4110

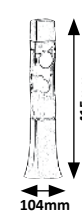

LOLLIPOP 2



4106

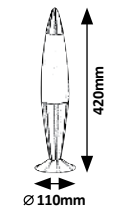

4108

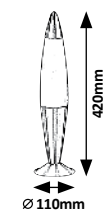

DOVCE

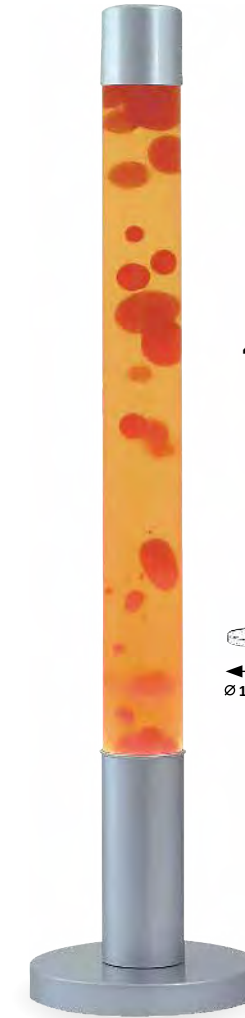

4111

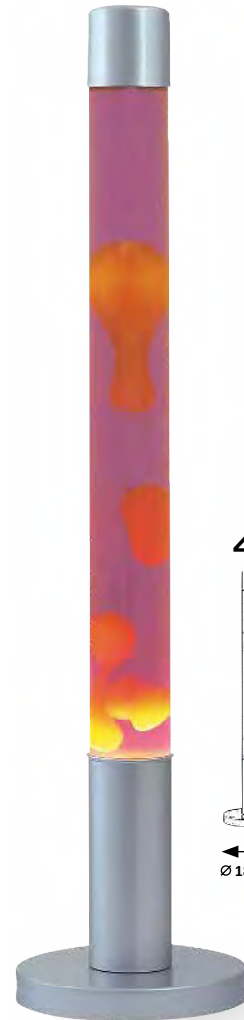
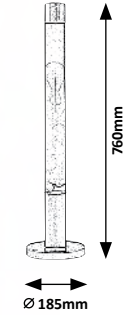

4112

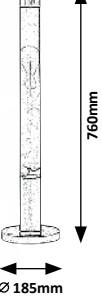

6949 P

LED / 5W incl.
DC 5V
IP20 • •
black/transparent



5 998250 369495

4109 P G

25W incl.
E14 / S35 / 1x max. 25W
IP20 • •
silver/red/yellow



5 998250 341095

4110 P G

25W incl.
E14 / S35 / 1x max. 25W
IP20 • •
silver/transparent/orange



5 998250 341101

4106 M G

25W incl.
E14 / G45 / 1x max. 25W
IP20 • •
silver/orange/purple



5 998250 341064

4108 M G

25W incl.
E14 / G45 / 1x max. 25W
IP20 • •
silver/transparent/rose



5 998250 341088

4111 M G

40W incl.
E14 / R50 / 1x max. 40W
IP20 • •
silver/red/yellow



5 998250 341118

4112 M G

40W incl.
E14 / R50 / 1x max. 40W
IP20 • •
silver/orange/purple



5 998250 341125



LOLLIPOP RAINBOW



7011

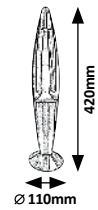

GLITTER RAINBOW



7008

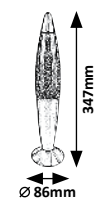

GLITTER



4113



4114



4115



MILLIE



4533

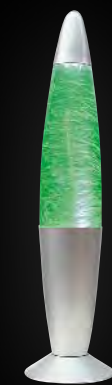

7011 **M G**

25W incl.
E14 / G45 / 1x max. 25W
IP20 •
multicolour/transparent



5 998250 370118

7008 **M G**

15W incl.
E14 / G45 / 1x max. 15W
IP20 •
multicolour/transparent



5 998250 370088

4113 **M G**

25W incl.
E14 / G45 / 1x max. 25W
IP20 •
silver/green



5 998250 341132

4114 **M G**

25W incl.
E14 / G45 / 1x max. 25W
IP20 •
silver/orange



5 998250 341149

4115 **M G**

25W incl.
E14 / G45 / 1x max. 25W
IP20 •
silver/purple



5 998250 341156

4533 **M G**

LED / 0,9W incl.
DC 5V
IP20
silver



5 998250 345338



WASABI

RGB LED WOOD **NEW**



3680 W S

RGB LED / 1W incl.
DC 5V
IP20
orange/oak



3696 W S

RGB LED / 1W incl.
DC 5V
IP20
orange/oak



FLORES

WARM White WOOD



FUJI

WARM White WOOD

2676 S W

15W (90lm, 2700K) incl.
E14 / 1x max. 15W
IP20 • ~3,5kg
brown/orange



4097 S W

15W (90lm, 2700K) incl.
E14 / 1x max. 15W
IP20 • ~2,5kg
brown/orange





ROCK

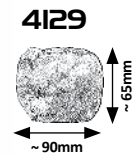

OZONE

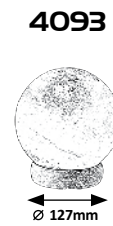

VESUVIUS

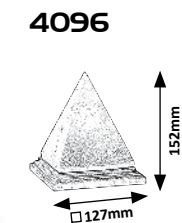

HEKLA

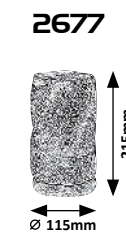

4120 **S** **W**
 15W (90lm, 2700K) incl.
 E14 / 1x max. 15W
 IP20 • ~2kg
 brown/orange



5 998250 341200

4127 **S** **W**
 15W (90lm, 2700K) incl.
 E14 / 1x max. 15W
 IP20 • ~2,7kg
 brown/orange



5 998250 341279

4129 **S**
 ~0,6kg
 orange



5 998250 341293

4130 **S** **W**
 15W (90lm, 2700K) incl.
 E14 / 1x max. 15W
 IP20 • ~8kg
 brown/orange



5 998250 341309

2677 **S** **W**
 15W (90lm, 2700K) incl.
 E14 / 1x max. 15W
 IP20 • ~3,5kg
 brown/orange



5 998250 326771

4093 **S** **W**
 15W (90lm, 2700K) incl.
 E14 / 1x max. 15W
 IP20 • ~2,5kg
 brown/orange



5 998250 340937

4096 **S** **W**
 15W (90lm, 2700K) incl.
 E14 / 1x max. 15W
 IP20 • ~2,5kg
 brown/orange



5 998250 340968



10

**BATHROOM,
PICTURE AND
CABINET LIGHTS**

**FÜRDŐSZOBAI, KÉP- ÉS
PULTMEGVILÁGÍTÓ LÁMPÁK**

**BADLEUCHTEN, BILD- UND
ARBEITSFLÄCHENBELEUCHTUNG**





ANTONIA

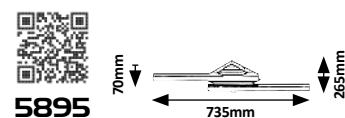
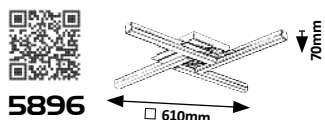

5895 (M) (P)

LED / 24W
(2360lm, 4000K) incl.
IP44
chrome/white



5 998250 358956

5896 (M) (P)

LED / 24W
(2200lm, 4000K) incl.
IP44
chrome/white



5 998250 358963

EVAN

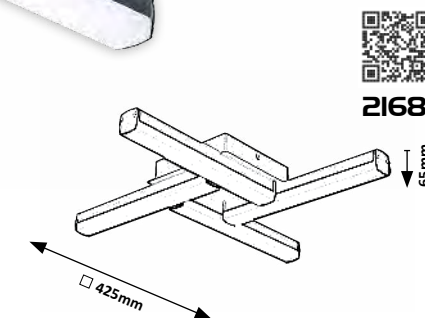
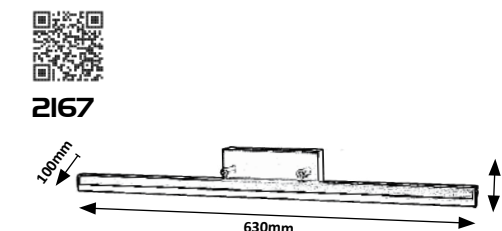
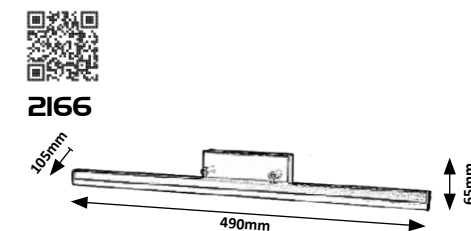

2166 (M) (P)

LED / 12W
(1300lm, 4000K) incl.
IP44
matte black/white



5 998250 321660

2167 (M) (P)

LED / 18W
(1850lm, 4000K) incl.
IP44
matte black/white



5 998250 321677

2168 (M) (P)

LED / 18W
(1750lm, 4000K) incl.
IP44
matte black/white



5 998250 321684



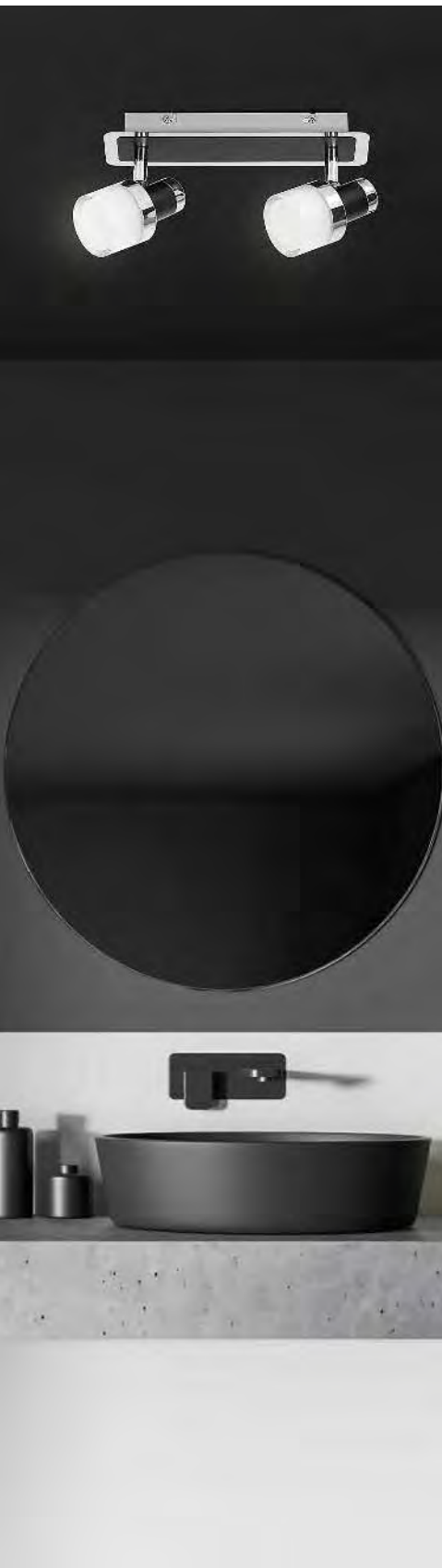

HAROLD

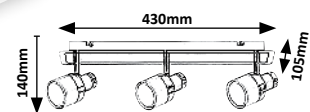
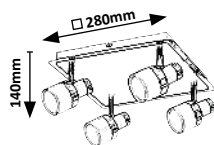
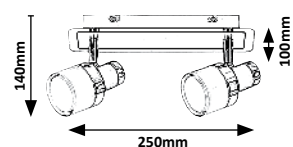
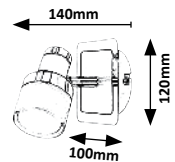

STEVE



5497

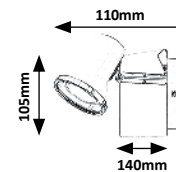

5498

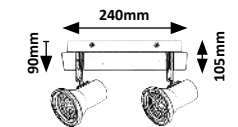

5500

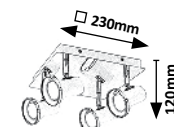

5499

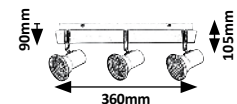

5021 (M) (P)

LED / 5W
(400lm, 4000K) incl.
IP44
chrome/black/opal glass



5 998250 350219

5022 (M) (P)

LED / 10W
(800lm, 4000K) incl.
IP44
chrome/black/opal glass



5 998250 350226

5023 (M) (P)

LED / 15W
(1200lm, 4000K) incl.
IP44
chrome/black/opal glass



5 998250 350233

5024 (M) (P)

LED / 20W
(1600lm, 4000K) incl.
IP44
chrome/black/opal glass



5 998250 350240

5497 (M)

LED / 4,5W (430lm, 4000K) incl.
GU10 / 1x max. 15W
IP44 • 19601
chrome/white



5 998250 354972

5498 (M)

LED / 9W (860lm, 4000K) incl.
GU10 / 2x max. 15W
IP44 • 19601
chrome/white



5 998250 354989

5499 (M)

LED / 13,5W (1290lm, 4000K) incl.
GU10 / 3x max. 15W
IP44 • 19601
chrome/white



5 998250 354996

5500 (M)

LED / 18W (1720lm, 4000K) incl.
GU10 / 4x max. 15W
IP44 • 19601
chrome/white



5 998250 355009

AVIVA

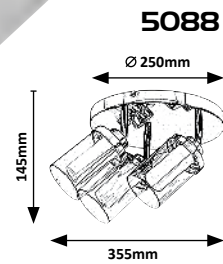
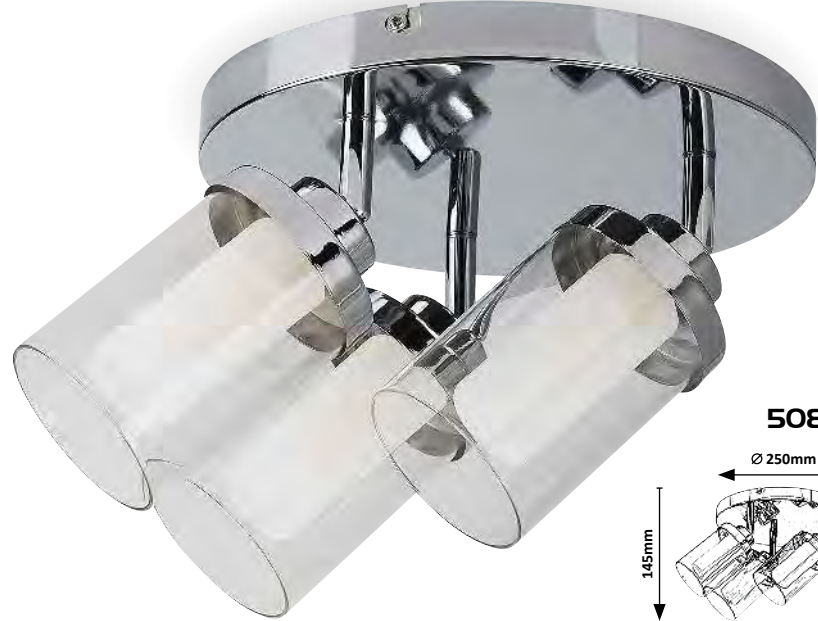
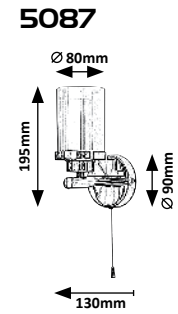

5087 **MG**

☒ G9 / 1x max. 28W
 IP44 •
 ▲ 19850, ▣ 19851
 chrome/opal glass/transparent



5 998250 350875

5088 **MG**

☒ G9 / 3x max. 28W
 IP44
 ▲ 19850, ▣ 19851
 chrome/opal glass/transparent



5 998250 350882

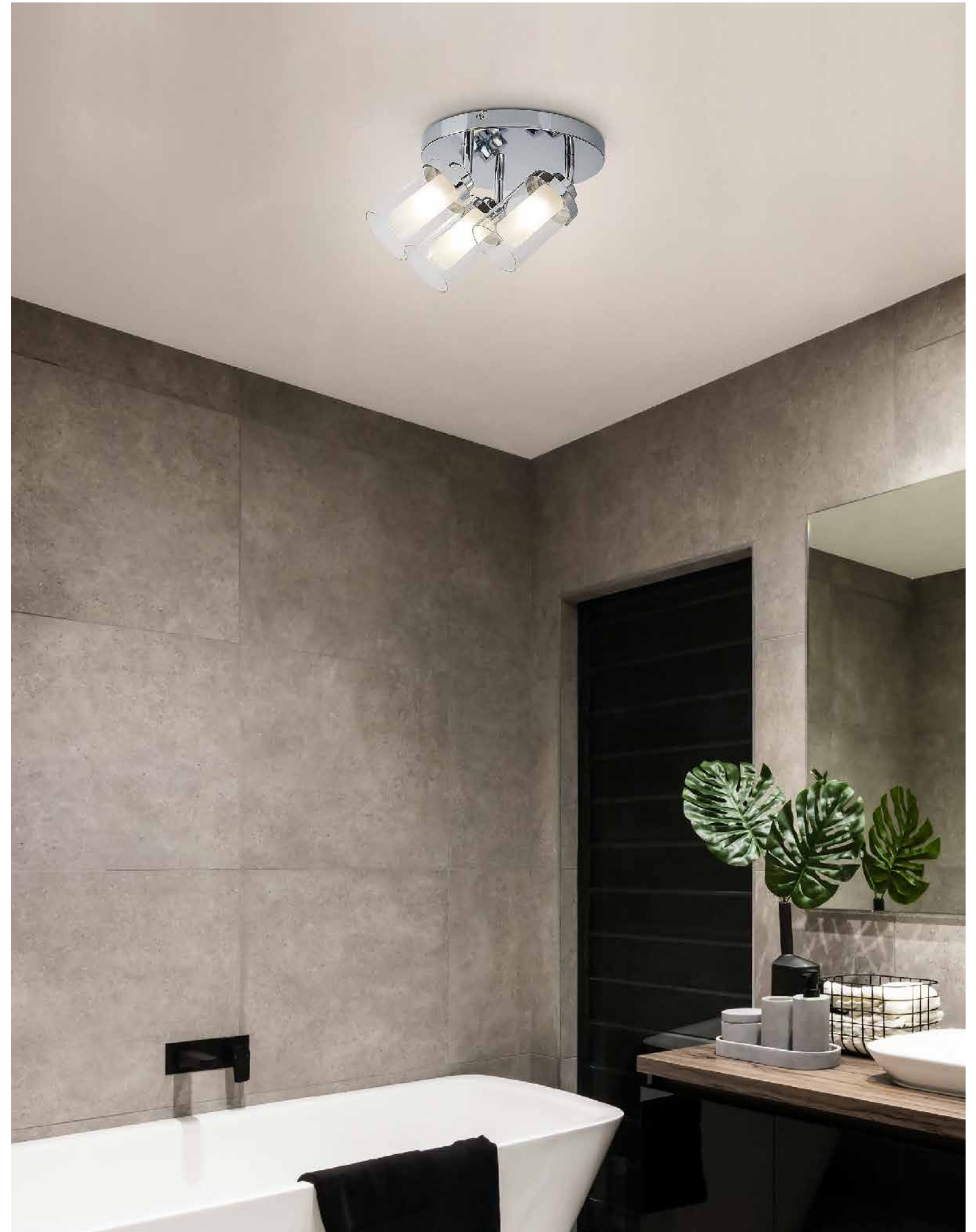



NIAGARA

 **NEW**



2194 **M G**

☒ E14 / 1x max. 40W
IP44
☐ 19953 • 🏠 19954
chrome/transparent



2195 **M G**

☒ E14 / 3x max. 40W
IP44
☐ 19953 • 🏠 19954
chrome/transparent



ANTOINE

 **NEW**



3207 **M G**

☒ E14 / 1x max. 40W
IP44 • 🏠 19955
chrome/transparent



3208 **M G**

☒ E14 / 2x max. 40W
IP44 • 🏠 19955
chrome/transparent



3209 **M G**

☒ E14 / 3x max. 40W
IP44 • 🏠 19955
chrome/transparent



3210 **M G**

☒ E14 / 3x max. 40W
IP44 • 🏠 19955
chrome/transparent





BEATA



5716 MP

LED / 5W
(465lm, 4000K) incl.
IP44
chrome/white



5717 MP

LED / 10W
(930lm, 4000K) incl.
IP44
chrome/white



5718 MP

LED / 15W
(1400lm, 4000K) incl.
IP44
chrome/white



BECCA

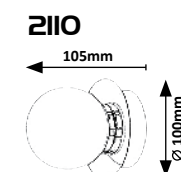

2110 MG

G9 / 1x max. 28W
IP44 • 19632
chrome/white



2111 MG

G9 / 2x max. 28W
IP44 • 19632
chrome/white



2112 MG

G9 / 3x max. 28W
IP44 • 19632
chrome/white



2113 MG

G9 / 3x max. 28W
IP44 • 19632
chrome/white





TONY

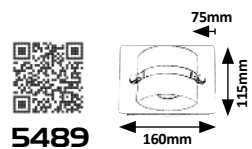

5489

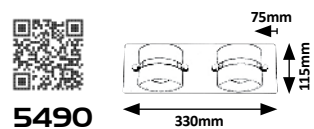

5490

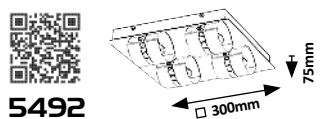

5492

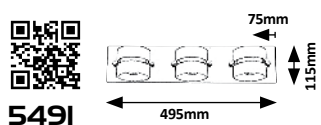

5491

5489 (MP)

LED / 5W
(365lm, 4000K) incl.
IP44 • 19600
chrome/opal glass



5 998250 354897

5490 (MP)

LED / 10W
(730lm, 4000K) incl.
IP44 • 19600
chrome/opal glass



5 998250 354903

5491 (MP)

LED / 15W
(1095lm, 4000K) incl.
IP44 • 19600
chrome/opal glass



5 998250 354910

5492 (MP)

LED / 20W
(1460lm, 4000K) incl.
IP44 • 19600
chrome/opal glass



5 998250 354927

RUBEN

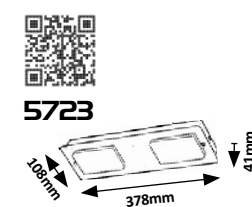
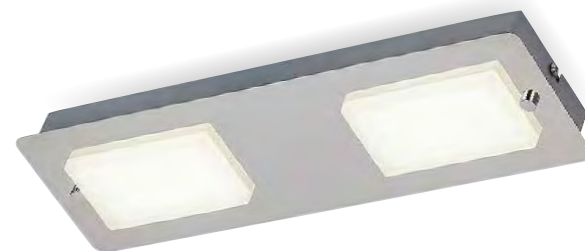

5723

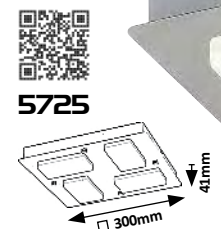

5725

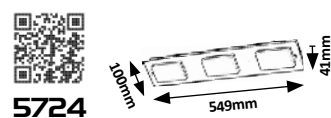

5724

5723 (MP)

LED / 9W
(774lm, 4000K) incl.
IP44
chrome/white



5 998250 357232

5724 (MP)

LED / 13,5W
(1161lm, 4000K) incl.
IP44
chrome/white



5 998250 357249

5725 (MP)

LED / 18W
(1548lm, 4000K) incl.
IP44
chrome/white



5 998250 357256



3464



WOLIMIR

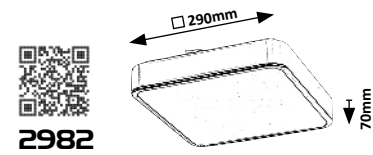
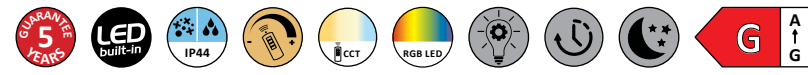

BALTHASAR

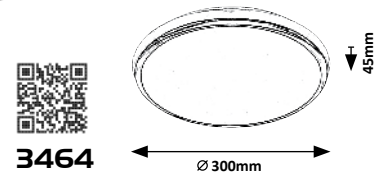
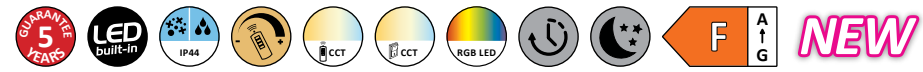

2982 (M A)

LED / 22W
(1800lm, 3000K-6000K) incl.
IP44 • 19643 • 519
chrome/white



3464 (M P)

LED / 18W
(1600lm, 3000K-6500K) incl.
IP44 • 19989 • 557
chrome/white



SLAVA

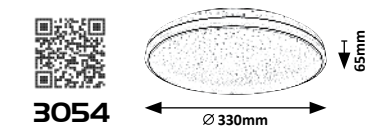

TOMA

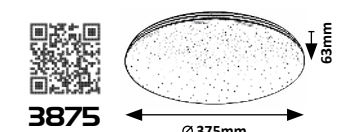
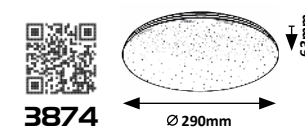

3054 (M A)

LED / 18W
(1170lm, 3000K) incl.
IP44 • 19902
black/white



3874 (M A)

LED / 20W
(1400lm, 4000K) incl.
IP44 • 19871
chrome/white



2982



3875 (M A)

LED / 30W
(2100lm, 4000K) incl.
IP44 • 19872
chrome/white





JEREMY

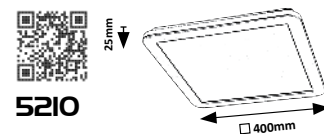
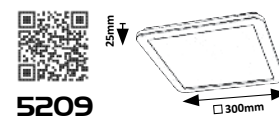
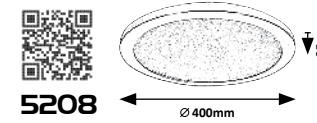
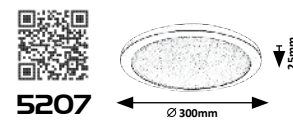
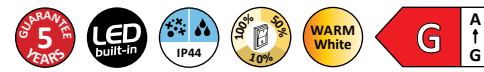

5207 (M) (P)

LED / 18W
(1200lm, 3000K) incl.
IP44
chrome/crystal



5 998250 352077

5208 (M) (P)

LED / 24W
(1500lm, 3000K) incl.
IP44
chrome/crystal



5 998250 352084

5209 (M) (P)

LED / 18W
(1200lm, 3000K) incl.
IP44
silver/white



5 998250 352091

5210 (M) (P)

LED / 24W
(1500lm, 3000K) incl.
IP44
silver/white



5 998250 352107

LAMBERT

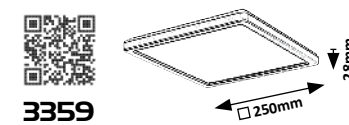
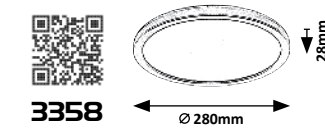

3358 (P)

LED / 15W
(1500lm, 4000K) incl.
IP44
silver/white



5 998250 333588

3359 (P)

LED / 15W
(1500lm, 4000K) incl.
IP44
silver/white



5 998250 333595



3358, 3359





LUCAS

OTHERS / BEST MATCH

 396-398.



CIBYLL



5832

ZENON



3437 **MP**
 LED / 12W
 (780lm, 4000K) incl.
 IP44 • 19714
 white

3438 **MP**
 LED / 18W
 (1170lm, 4000K) incl.
 IP44 • 19715
 white

3439 **MP**
 LED / 24W
 (1560lm, 4000K) incl.
 IP44 • 19716
 white

5832 **MG**
 E27 / 1x max. 60W
 IP44
 19817
 white

2697 **P**
 LED / 18W
 (1800lm, 3000K-4000K-6000K) incl.
 IP54
 white

2698 **P**
 LED / 24W
 (2400lm, 3000K-4000K-6000K) incl.
 IP54
 white

2699 **P**
 LED / 18W
 (1800lm, 3000K-4000K-6000K) incl.
 IP54 • 10m, 360°
 white

2700 **P**
 LED / 24W
 (2400lm, 3000K-4000K-6000K) incl.
 IP54 • 10m, 360°
 white



EVERY



TOGO



ABBEY



3998 MG

LED / 6W
(550lm, 4000K) incl.
IP44 • 19669
chrome/white



5 998250 339986

3999 MG

LED / 6W
(550lm, 3000K) incl.
IP44 • 19669
antique bronze/white



5 998250 339993

1302 MG

E14 / 1x max. 40W
IP44 • 9973
bronze/white



5 998250 313023

5827 MG

E14 / 1x max. 40W
IP44 • 9973
chrome/white



5 998250 358277

5786 MP

LED / 10W
(900lm, 3000K) incl.
IP44
antique bronze



5 998250 357867

5787 MP

LED / 10W
(900lm, 4000K) incl.
IP44
chrome



5 998250 357874

YAGO

IP44 2in1 **NEW**



2in1 Bathroom/Outdoor lamp • Fürdőszobai/Kültéri lámpa • Badleuchten/Aussenleuchten

3309 **M G**
 ☒ E27 / 1x max. 60W
 IP44 • 19984
 chrome/transparent



3310 **M G**
 ☒ E27 / 1x max. 60W
 IP44 • 19984
 matte black/transparent



BETTY

5 YEARS GUARANTEE LED built-in IP44 NATURAL White **F** A G



JIM

5 YEARS GUARANTEE LED built-in IP44 NATURAL White **G** A G



<p>5713 M G ☒ LED / 4W (371lm, 4000K) incl. IP44 • 19587 chrome/opal glass</p>	<p>5714 M G ☒ LED / 8W (785lm, 4000K) incl. IP44 • 19588 chrome/opal glass</p>	<p>5745 M G ☒ LED / 4W (371lm, 4000K) incl. IP44 • 19587 bronze/white</p>	<p>5746 M G ☒ LED / 8W (785lm, 4000K) incl. IP44 • 19588 bronze/white</p>	<p>5749 M G ☒ LED / 5W (400lm, 4000K) incl. IP44 • 19589 chrome/white</p>	<p>5750 M G ☒ LED / 10W (800lm, 4000K) incl. IP44 • 19590 chrome/white</p>
--	--	---	---	---	--

SILAS

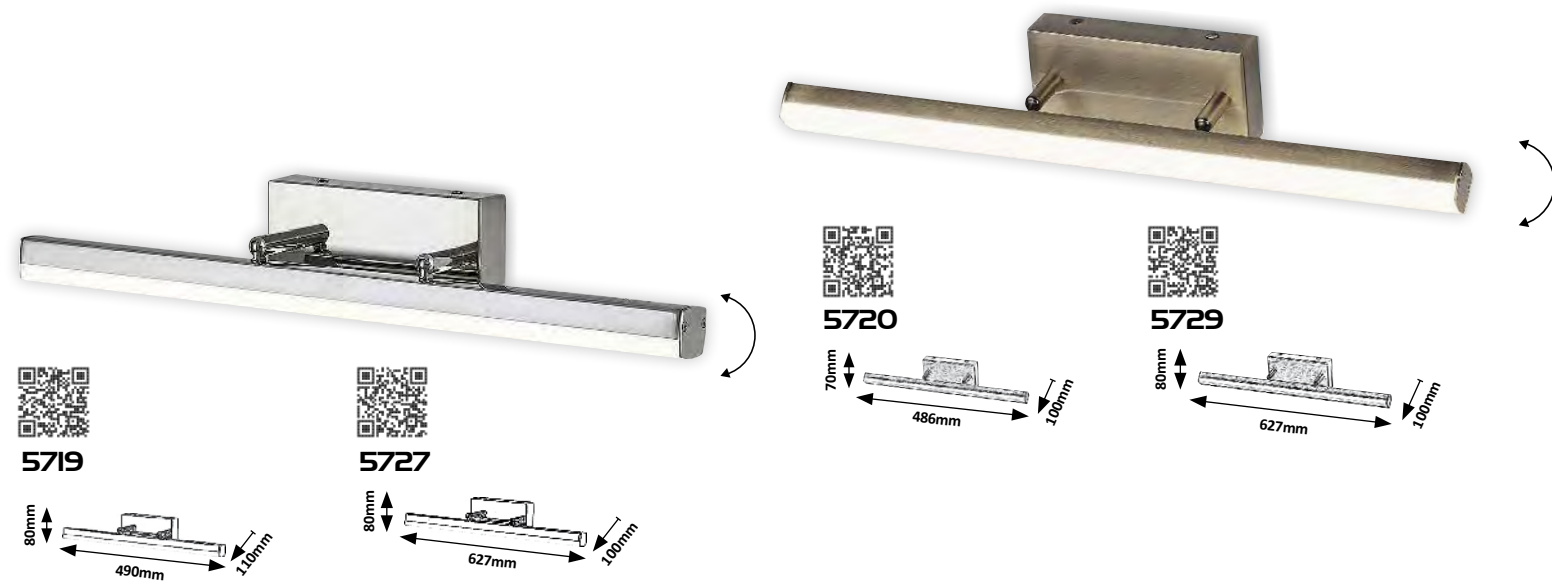

LIAM



JOHN

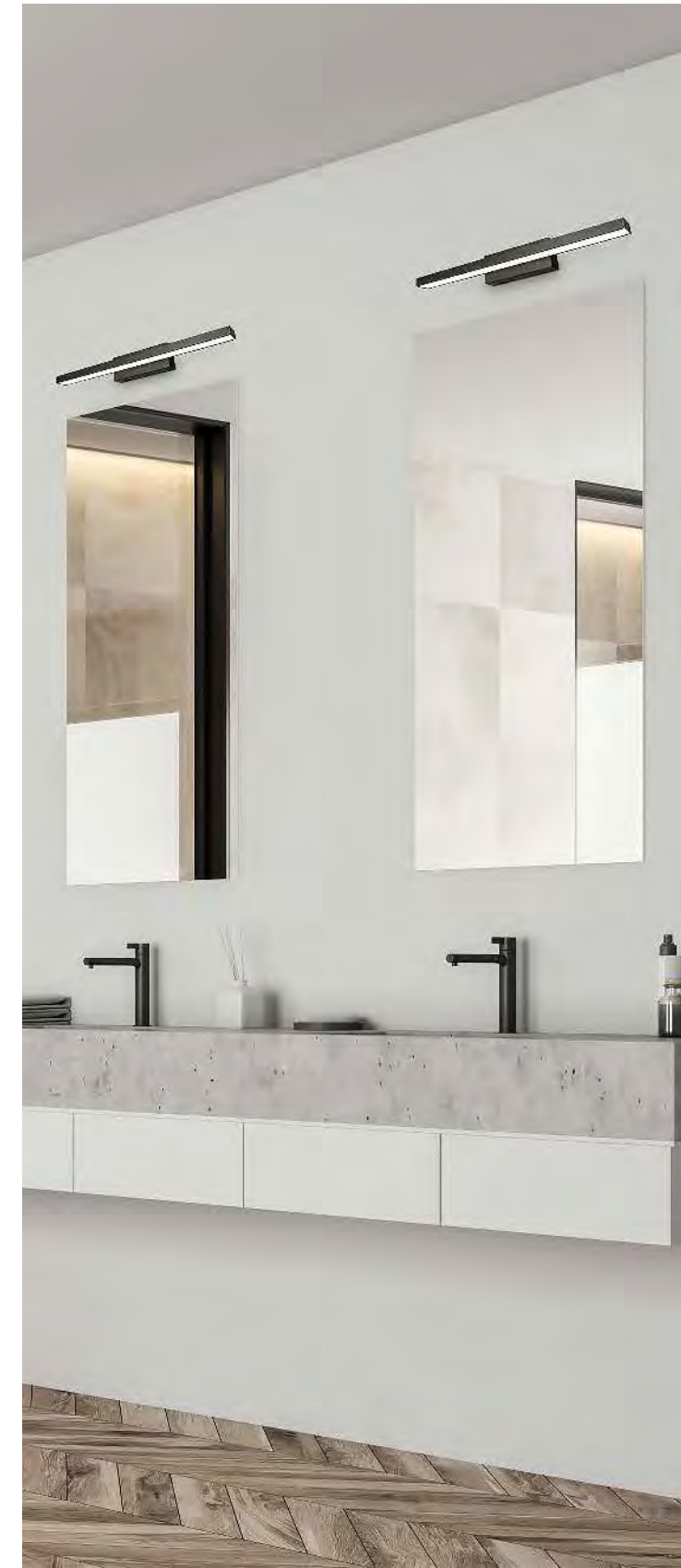
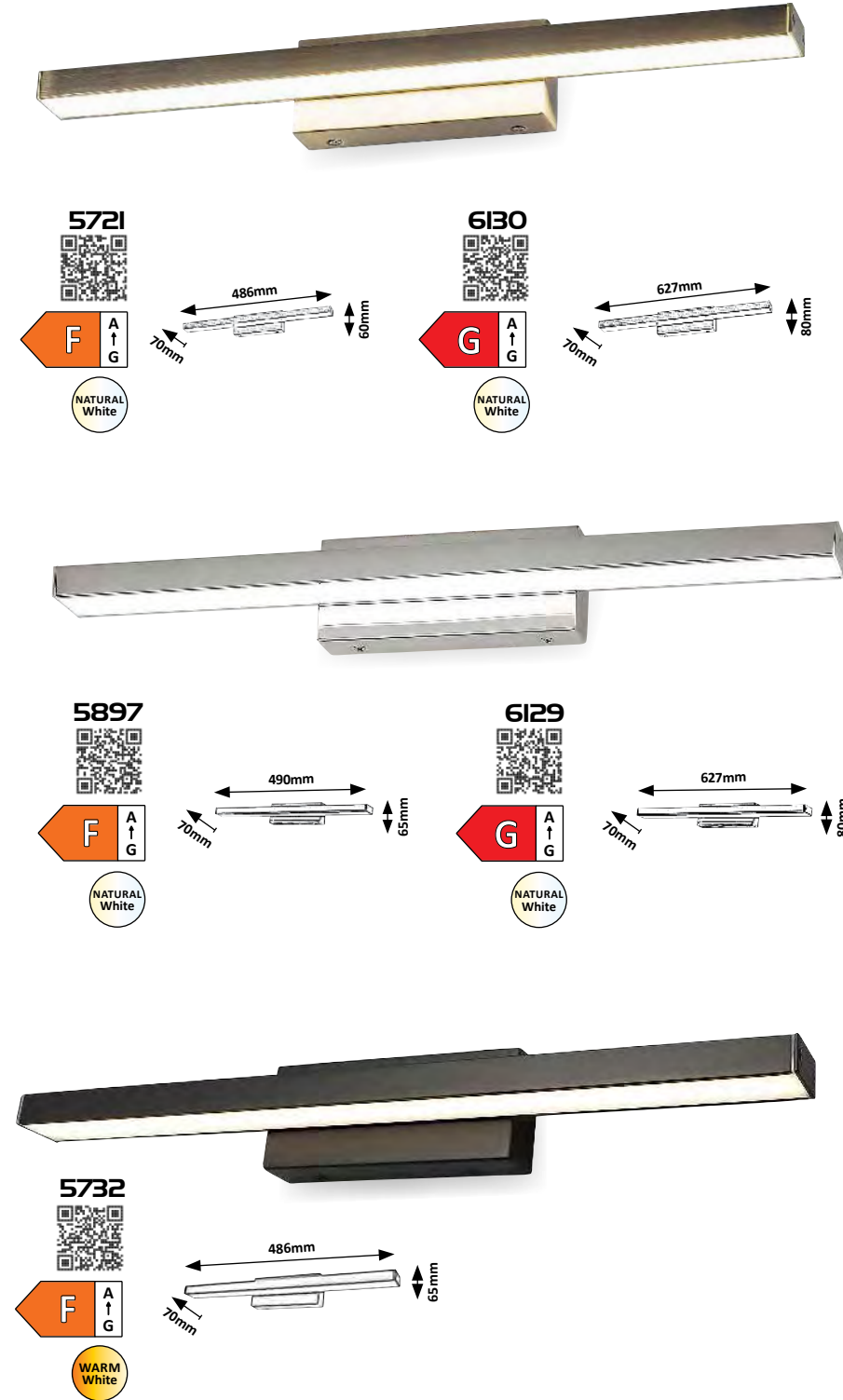

5719 (MP)

LED / 12W
(1180lm, 4000K) incl.
IP44
chrome



5 998250 357195

5720 (MP)

LED / 12W
(1180lm, 4000K) incl.
IP44
bronze



5 998250 357201

5727 (MP)

LED / 18W
(1700lm, 4000K) incl.
IP44
chrome



5 998250 357270

5729 (MP)

LED / 18W
(1700lm, 4000K) incl.
IP44
bronze



5 998250 357294

6230 (M)

LED / 5W
(400lm, 4000K) incl.
IP44
chrome



5 998250 362304

5721 (MP)

LED / 12W
(1080lm, 4000K) incl.
IP44
bronze



5 998250 357218

5732 (MP)

LED / 12W
(930lm, 3000K) incl.
IP44
matte black



5 998250 357324

5897 (MP)

LED / 12W
(1080lm, 4000K) incl.
IP44
chrome



5 998250 358970

6129 (MP)

LED / 18W
(1300lm, 4000K) incl.
IP44
chrome



5 998250 361291

6130 (MP)

LED / 18W
(1300lm, 4000K) incl.
IP44
bronze



5 998250 361307

JAKUB

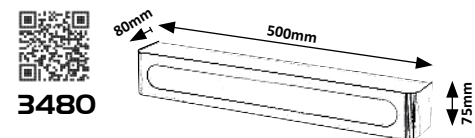
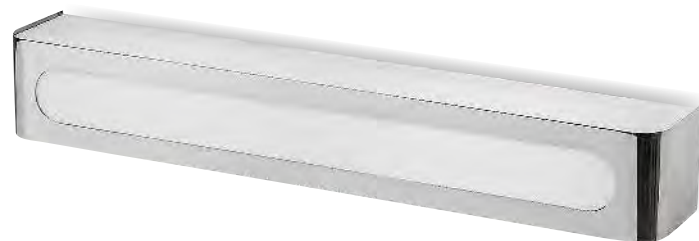
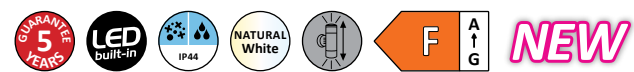

DANTON

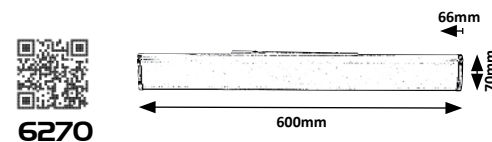
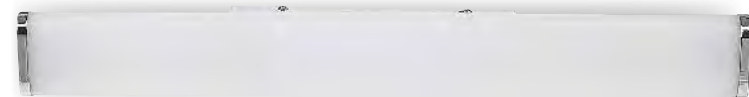

EVRON

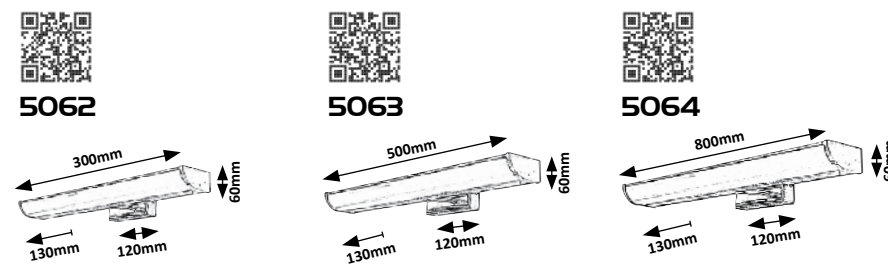

MATT

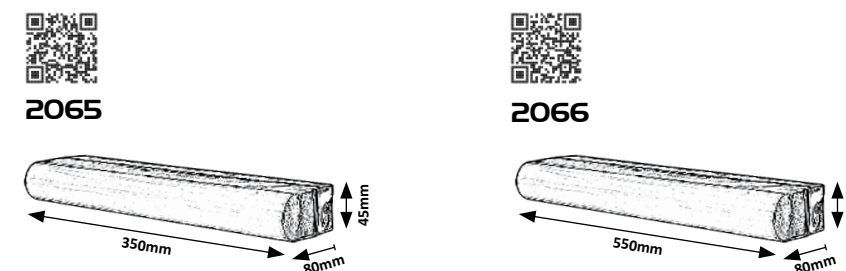

3480 (M) (P)
 LED / 12W
 (1280lm, 4000K) incl.
 IP44
 chrome/white
 5 998250 334806

6270 (M) (P)
 LED / 14W
 (1220lm, 3000K) incl.
 IP44
 chrome/white
 5 998250 362700

5062 (M) (P)
 LED / 5W
 (400lm, 4000K) incl.
 IP44
 chrome/white
 5 998250 350622

5063 (M) (P)
 LED / 7,5W
 (600lm, 4000K) incl.
 IP44
 chrome/white
 5 998250 350639

5064 (M) (P)
 LED / 13,5W
 (1080lm, 4000K) incl.
 IP44
 chrome/white
 5 998250 350646

2065 (M) (P)
 LED / 10W
 (960lm, 4000K) incl.
 IP44
 chrome/white
 5 998250 320656

2066 (M) (P)
 LED / 15W
 (1360lm, 4000K) incl.
 IP44
 chrome/white
 5 998250 320663



2114, 2115 3in1



Wall • Fal • Wand



Mirror • Tükör • Spiegel



Furniture • Bútor • Möbel

ALBINA

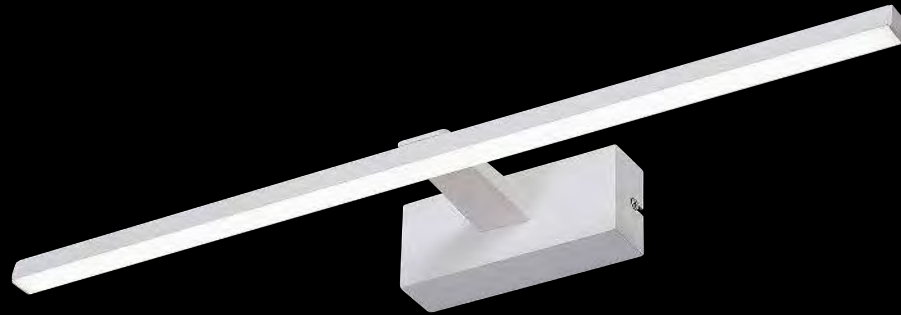

1448

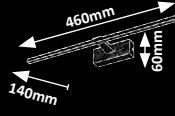

1449

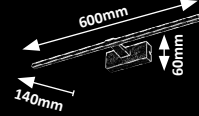

1464

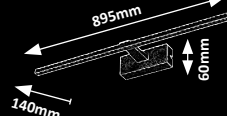

LEVON

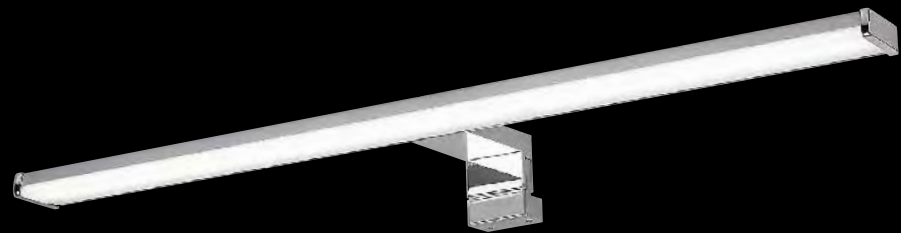

2114

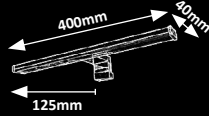

2115

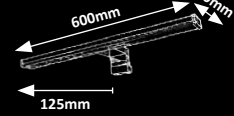

ANDREW



5782

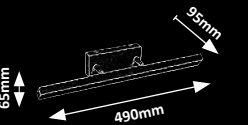

SPENCER



5783

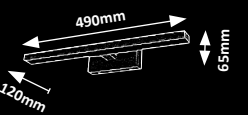

BASTIAN



5781

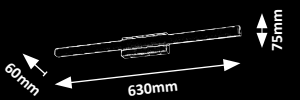

1448 MP

LED / 8W
(450lm, 4000K) incl.
IP23
matte white



5 998250 314488

1449 MP

LED / 12W
(795lm, 4000K) incl.
IP23
matte white



5 998250 314495

1464 MP

LED / 18W
(900lm, 4000K) incl.
IP23
matte white



5 998250 314648

2114 MP

LED / 8W
(560lm, 4000K) incl.
IP44
chrome



5 998250 321141

2115 MP

LED / 12W
(840lm, 4000K) incl.
IP44
chrome



5 998250 321158

5782 MP

LED / 12W
(820lm, 3000K) incl.
IP44
matte white



5 998250 357829

5783 MP

LED / 12W
(820lm, 3000K) incl.
IP44
matte white



5 998250 357836

5781 MP

LED / 13W
(1120lm, 4000K) incl.
IP44
chrome



5 998250 357812



PERIODIC

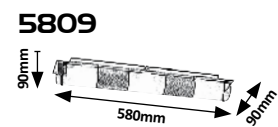
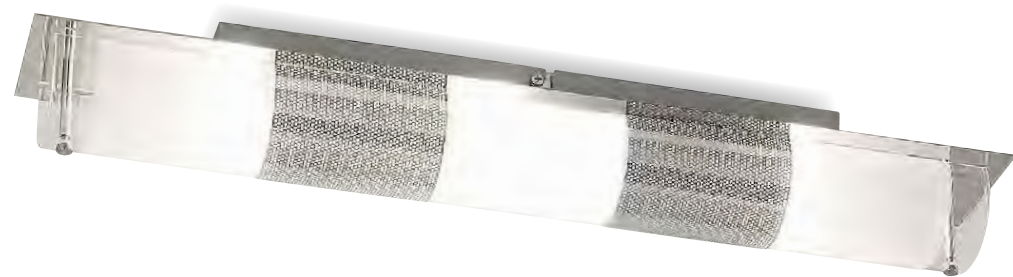
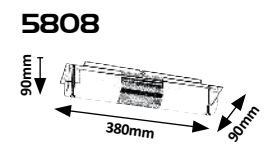

5800 **MG**
 ☒ E14 / 1x max. 40W
 IP20 • 9730
 chrome/transparent/opal glass



5808 **MG**
 ☒ E14 / 2x max. 40W
 IP20 • 9593
 chrome/transparent/opal glass



5809 **MG**
 ☒ E14 / 3x max. 40W
 IP20 • 9594
 chrome/transparent/opal glass



BYRON

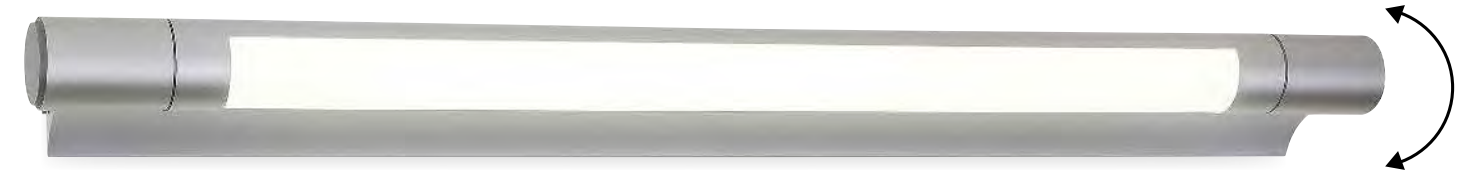

I444

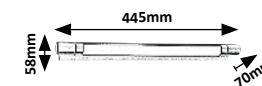

I445

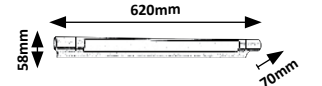

I444 **MP**
 ☒ LED / 4W
 (250lm, 4000K) incl.
 IP20 •
 silver



I445 **MP**
 ☒ LED / 8W
 (546lm, 4000K) incl.
 IP20 •
 silver



illustration

PAULA

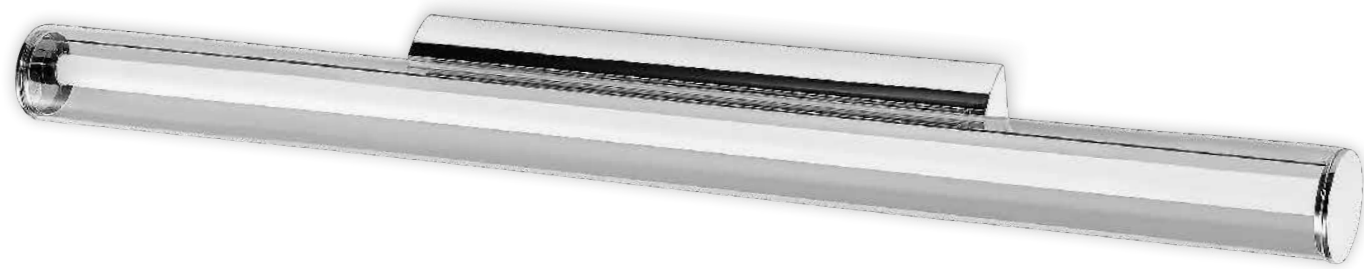

6749

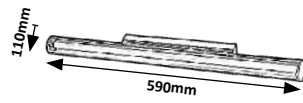

6750

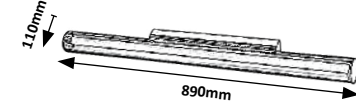

HANSON

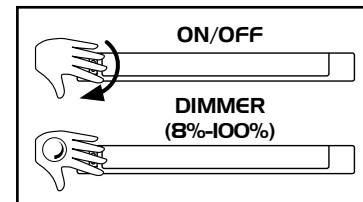
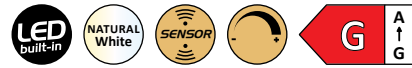

5674

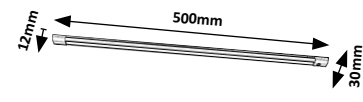

EASY LIGHT



2361

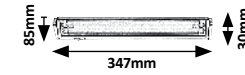

2362

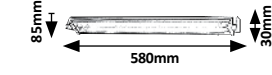

2363

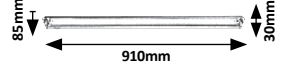

2364

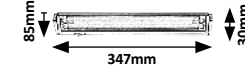

2365

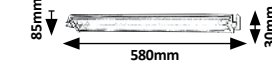

2366

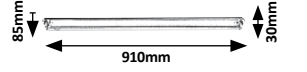

6749 M P G

LED / 12W
(1000lm, 4000K) incl.
IP20 • 19828
chrome/transparent



5 998250 367491

6750 M P G

LED / 18W
(1400lm, 4000K) incl.
IP20 • 19829
chrome/transparent



5 998250 367507

5674 P

LED / 8W
(560lm, 4000K) incl.
IP20 • 120°
grey/white



5 998250 356747

2361 M G

8W
(480lm, 2700K) incl.
G5 / T5 / 1x max. 8W
IP20 • white



5 998250 323619

2362 M G

13W
(820lm, 2700K) incl.
G5 / T5 / 1x max. 13W
IP20 • white



5 998250 323626

2363 M G

21W
(1890lm, 2700K) incl.
G5 / T5 / 1x max. 21W
IP20 • white



5 998250 323633

2364 M G

8W
(480lm, 2700K) incl.
G5 / T5 / 1x max. 8W
IP20 • silver



5 998250 323640

2365 M G

13W
(820lm, 2700K) incl.
G5 / T5 / 1x max. 13W
IP20 • silver



5 998250 323657

2366 M G

21W
(1890lm, 2700K) incl.
G5 / T5 / 1x max. 21W
IP20 • silver



5 998250 323664

BATTEN LIGHT



I450

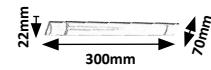

I451

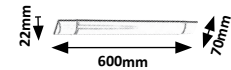

I452



I453

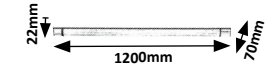

I450 (P)

LED / 10W
(800lm, 4000K) incl.
IP20
white



5 998250 314501

I451 (P)

LED / 20W
(1600lm, 4000K) incl.
IP20
white



5 998250 314518

I452 (P)

LED / 30W
(2400lm, 4000K) incl.
IP20
white



5 998250 314525

I453 (P)

LED / 40W
(3200lm, 4000K) incl.
IP20
white



5 998250 314532

SLIM

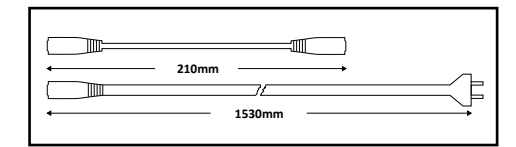

2341

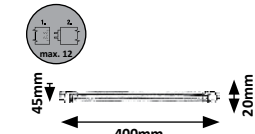

2342

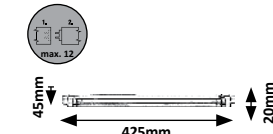

2343

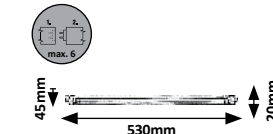

2344

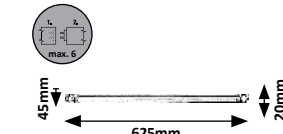

2345

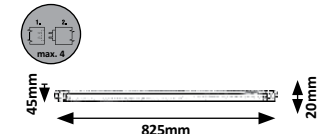

2341 (P)

8W (520lm, 2700K) incl.
G5 / T4 / 1x max. 8W
IP20 •
white



5 998250 323411

2342 (P)

12W (850lm, 2700K) incl.
G5 / T4 / 1x max. 12W
IP20 •
white



5 998250 323428

2343 (P)

16W (1230lm, 2700K) incl.
G5 / T4 / 1x max. 16W
IP20 •
white



5 998250 323435

2344 (P)

20W (1500lm, 2700K) incl.
G5 / T4 / 1x max. 20W
IP20 •
white



5 998250 323442

2345 (P)

30W (2500lm, 2700K) incl.
G5 / T4 / 1x max. 30W
IP20 •
white



5 998250 323459

GREG

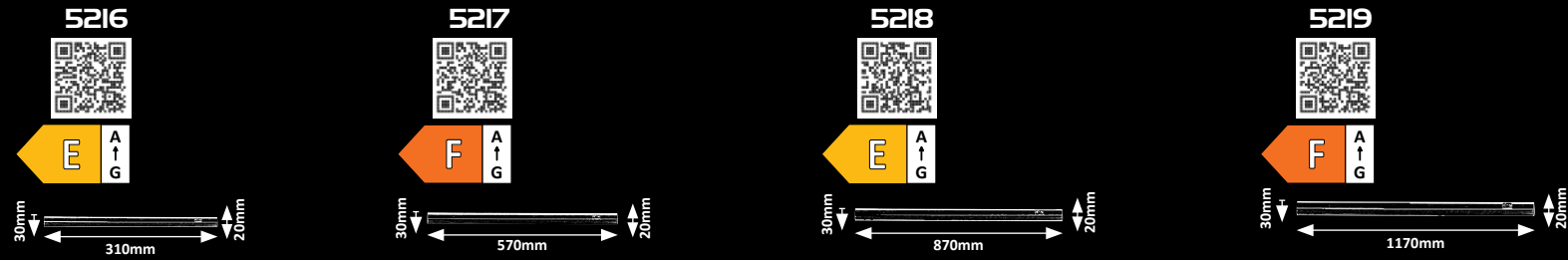

- | | | | |
|---|---|---|---|
| <p>5216 (P)</p> <p>LED / 4W
(400lm, 4000K) incl.
IP20 • □
white</p> <p>5 998250 352169</p> | <p>5217 (P)</p> <p>LED / 9W
(800lm, 4000K) incl.
IP20 • □
white</p> <p>5 998250 352176</p> | <p>5218 (P)</p> <p>LED / 13W
(1300lm, 4000K) incl.
IP20 • □
white</p> <p>5 998250 352183</p> | <p>5219 (P)</p> <p>LED / 18W
(1800lm, 4000K) incl.
IP20 • □
white</p> <p>5 998250 352190</p> |
|---|---|---|---|

STREAK LIGHT

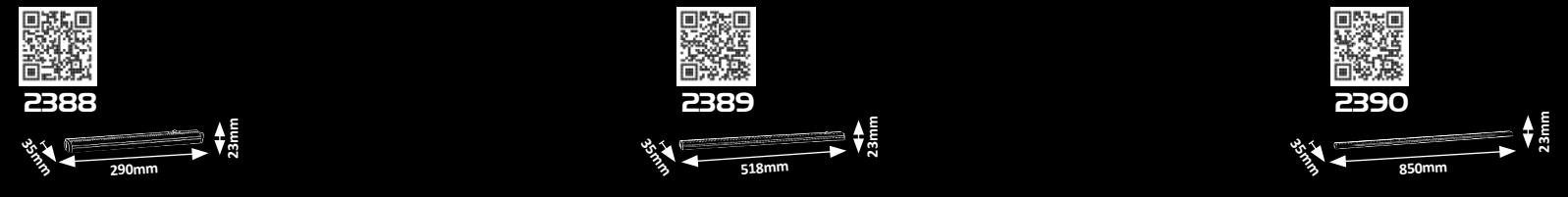

- | | | |
|---|---|---|
| <p>2388 (P)</p> <p>LED / 4W
(300lm, 3000K) incl.
IP20 • □
white</p> <p>5 998250 323886</p> | <p>2389 (P)</p> <p>LED / 7W
(550lm, 3000K) incl.
IP20 • □
white</p> <p>5 998250 323893</p> | <p>2390 (P)</p> <p>LED / 13W
(1050lm, 3000K) incl.
IP20 • □
white</p> <p>5 998250 323909</p> |
|---|---|---|

BATH

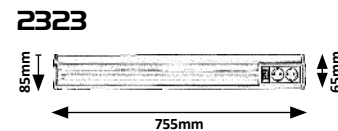
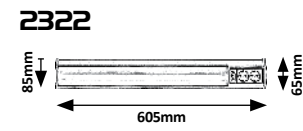
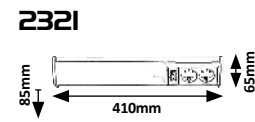
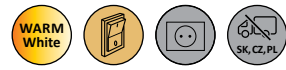

2321 (M) (P)
 11W (840lm, 2700K) incl.
 G23 / PL / 1x max. 11W
 IP20 •
 white

2322 (M) (P)
 15W (950lm, 2700K) incl.
 G13 / T8 / 1x max. 15W
 IP20 •
 white

2323 (M) (P)
 18W (1350lm, 2700K) incl.
 G13 / T8 / 1x max. 18W
 IP20 •
 white

SOFT

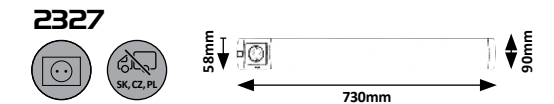
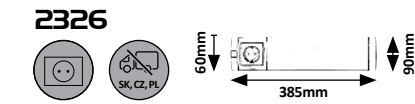
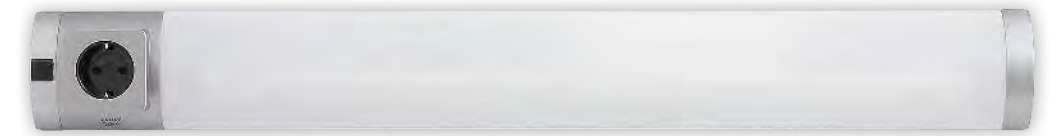

2326 (P)
 11W (840lm, 2700K) incl.
 G23 / PL / 1x max. 11W
 IP20 •
 silver





2327 (P)
 18W (1350lm, 2700K) incl.
 G13 / T8 / 1x max. 18W
 IP20 •
 silver

2328 (P)
 10W (630lm, 2700K) incl.
 G13 / T8 / 1x max. 10W
 IP20 •
 silver

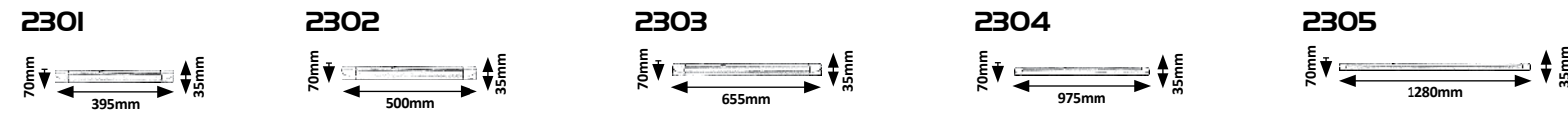
2329 (P)
 18W (1350lm, 2700K) incl.
 G13 / T8 / 1x max. 18W
 IP20 •
 silver

BAND LIGHT



<p>2301 M P</p> <p>☑ 10W (630lm, 2700K) incl. G13 / T8 / 1x max. 10W IP20 • 🗄️ • 🗄️ 19685 white</p>  <p>5 998250 323015</p>	<p>2302 M P</p> <p>☑ 15W (950lm, 2700K) incl. G13 / T8 / 1x max. 15W IP20 • 🗄️ • 🗄️ 19686 white</p>  <p>5 998250 323022</p>	<p>2303 M P</p> <p>☑ 18W (1380lm, 2700K) incl. G13 / T8 / 1x max. 18W IP20 • 🗄️ • 🗄️ 19687 white</p>  <p>5 998250 323039</p>	<p>2304 M P</p> <p>☑ 30W (2400lm, 2700K) incl. G13 / T8 / 1x max. 30W IP20 • 🗄️ • 🗄️ 19688 white</p>  <p>5 998250 323046</p>	<p>2305 M P</p> <p>☑ 36W (3350lm, 2700K) incl. G13 / T8 / 1x max. 36W IP20 • 🗄️ • 🗄️ 19689 white</p>  <p>5 998250 323053</p>
--	--	---	--	---

BAND LIGHT



<p>2306 M P</p> <p>☑ 10W (630lm, 2700K) incl. G13 / T8 / 1x max. 10W IP20 • 🗄️ • 🗄️ 19685 silver</p>  <p>5 998250 323060</p>	<p>2307 M P</p> <p>☑ 15W (950lm, 2700K) incl. G13 / T8 / 1x max. 15W IP20 • 🗄️ • 🗄️ 19686 silver</p>  <p>5 998250 323077</p>	<p>2308 M P</p> <p>☑ 18W (1350lm, 2700K) incl. G13 / T8 / 1x max. 18W IP20 • 🗄️ • 🗄️ 19687 silver</p>  <p>5 998250 323084</p>	<p>2309 M P</p> <p>☑ 36W (3350lm, 2700K) incl. G13 / T8 / 1x max. 36W IP20 • 🗄️ • 🗄️ 19689 silver</p>  <p>5 998250 323091</p>
---	---	--	--

PICTURE GUARD

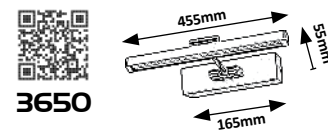
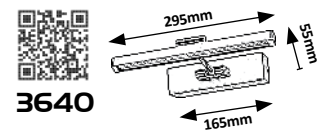
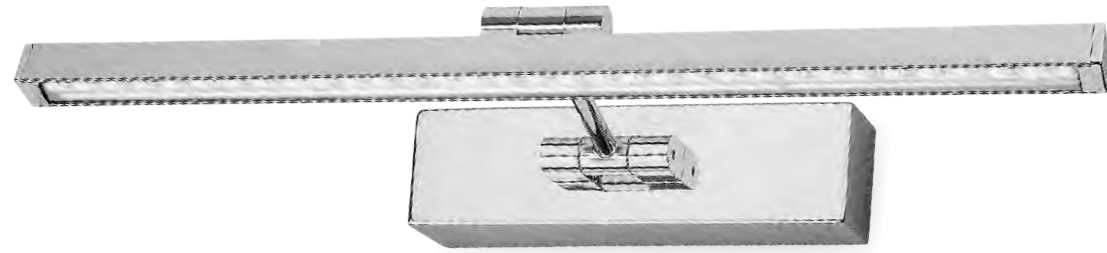

PICTURE LIGHT

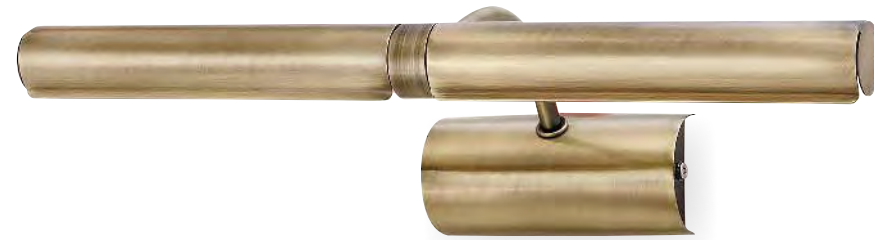
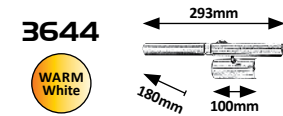
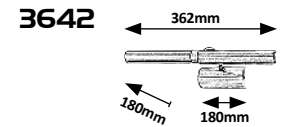
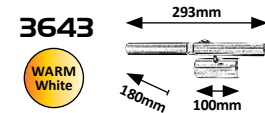
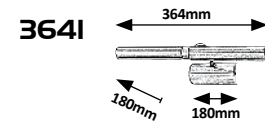

3640 (M)	3650 (M)	3641 (M)	3642 (M)	3643 (M)	3644 (M)
LED / 5W (300lm, 3000K) incl. IP20 chrome	LED / 8W (580lm, 3000K) incl. IP20 chrome	E14 / T25 / 2x max. 40W IP20 satin chrome	E14 / T25 / 2x max. 40W IP20 bronze	28W (370lm, 2700K) incl. G9 / 2x max. 40W IP20 satin chrome	28W (370lm, 2700K) incl. G9 / 2x max. 40W IP20 bronze
5 998250 336404	5 998250 336503	5 998250 336411	5 998250 336428	5 998250 336435	5 998250 336442

PICTURE SLIM

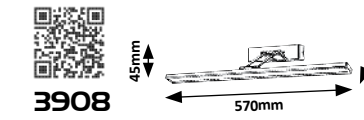
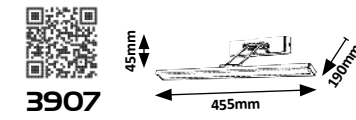
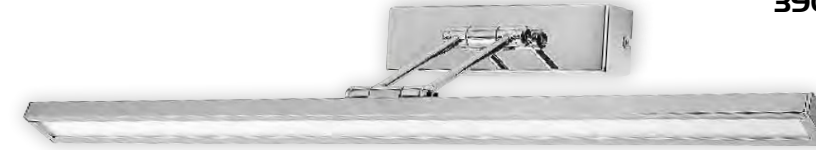
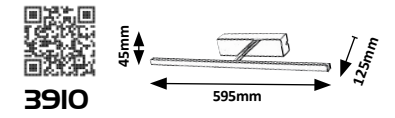
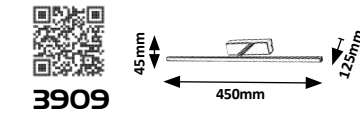
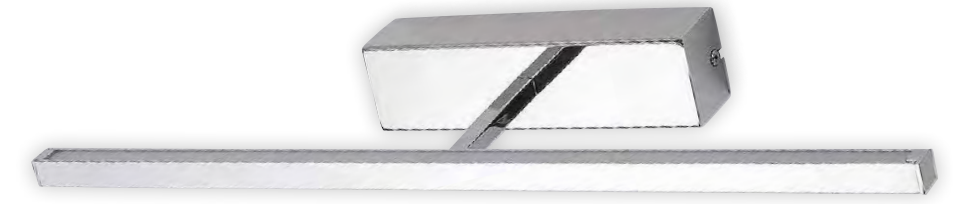

LUDOVIC

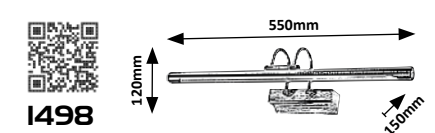
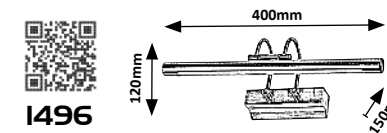

3907 (M)	3908 (M)	3909 (M)	3910 (M)	I496 (M P)	I498 (M P)
LED / 8W (316lm, 4000K) incl. IP20 chrome	LED / 12W (466lm, 4000K) incl. IP20 chrome	LED / 8W (321lm, 4000K) incl. IP20 chrome	LED / 12W (554lm, 4000K) incl. IP20 chrome	LED / 9W (810lm, 3000K) incl. IP20 bronze	LED / 13W (1170lm, 3000K) incl. IP20 bronze
5 998250 339078	5 998250 339085	5 998250 339092	5 998250 339108	5 998250 314969	5 998250 314983

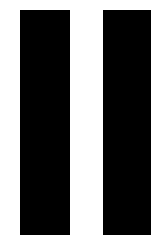

RECESSED AND SURFACE MOUNTED LIGHTING

**BE- ÉS
RÁÉPÍTHETŐ LÁMPÁK**

**EIN- UND
AUFBAULEUCHTEN**



KOBALD

NEW



2047

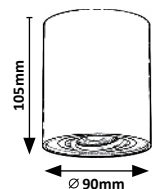

2048

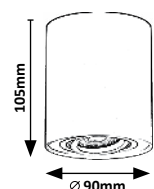

2049

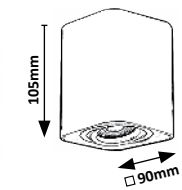

2050

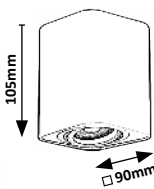

KOBALD

NEW



2051

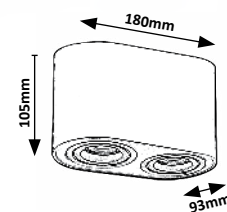

2053

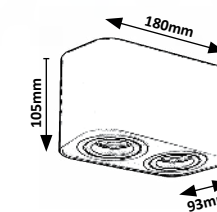

2052

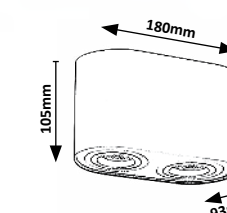

2054

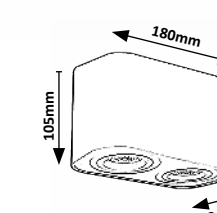

2055

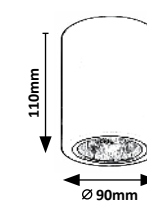

2056

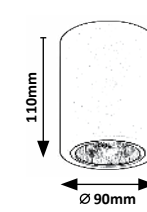

2047 **M**
 ☒ GU10 / 1x max. 42W
 IP20
 matte black



5 998250 320472

2048 **M**
 ☒ GU10 / 1x max. 42W
 IP20
 matte white



5 998250 320489

2049 **M**
 ☒ GU10 / 1x max. 42W
 IP20
 matte black



5 998250 320496

2050 **M**
 ☒ GU10 / 1x max. 42W
 IP20
 matte white



5 998250 320502

2051 **M**
 ☒ GU10 / 2x max. 42W
 IP20
 matte black



5 998250 320519

2052 **M**
 ☒ GU10 / 2x max. 42W
 IP20
 matte white



5 998250 320526

2053 **M**
 ☒ GU10 / 2x max. 42W
 IP20
 matte black



5 998250 320533

2054 **M**
 ☒ GU10 / 2x max. 42W
 IP20
 matte white



5 998250 320540

2055 **M**
 ☒ E27 / G45 / 1x max. 25W
 IP20
 matte black/chrome



5 998250 320557

2056 **M**
 ☒ E27 / G45 / 1x max. 25W
 IP20
 matte white/chrome



5 998250 320564



DONALD



MADDOX

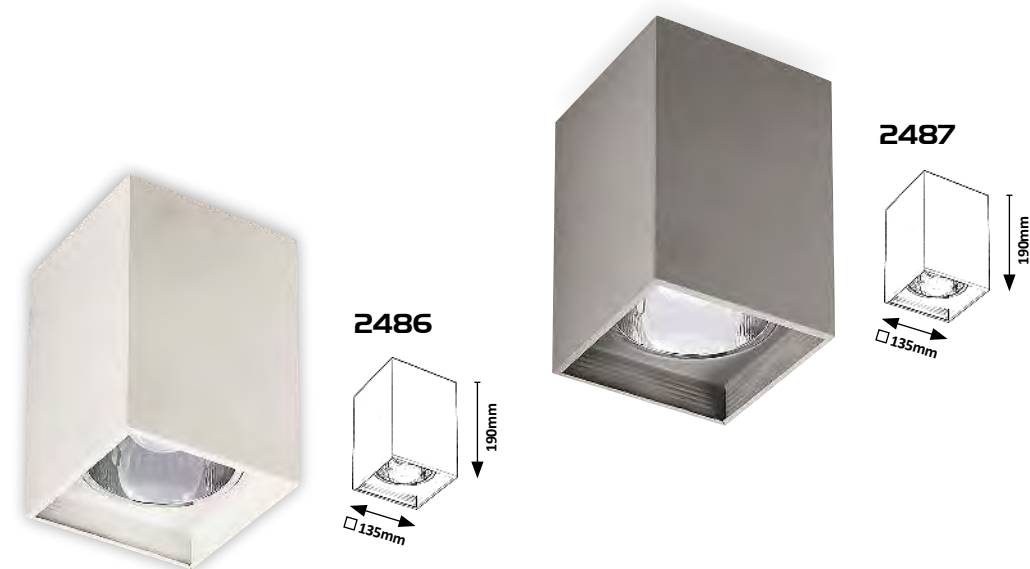

SONNET

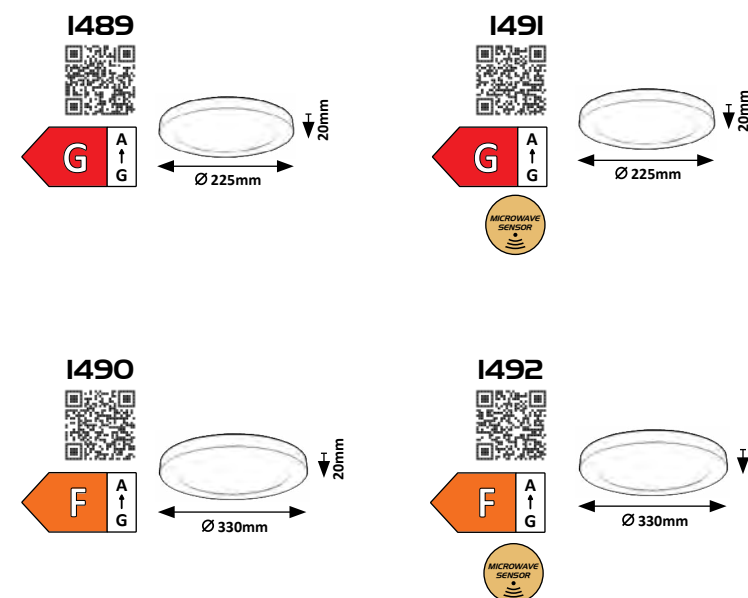

2in1 Surface mounted • Ráépíthető • Aufbau



2in1 Recessed • Beépíthető • Einbau



Movable spring
Állítható beépítési méret
Bewegliche Feder

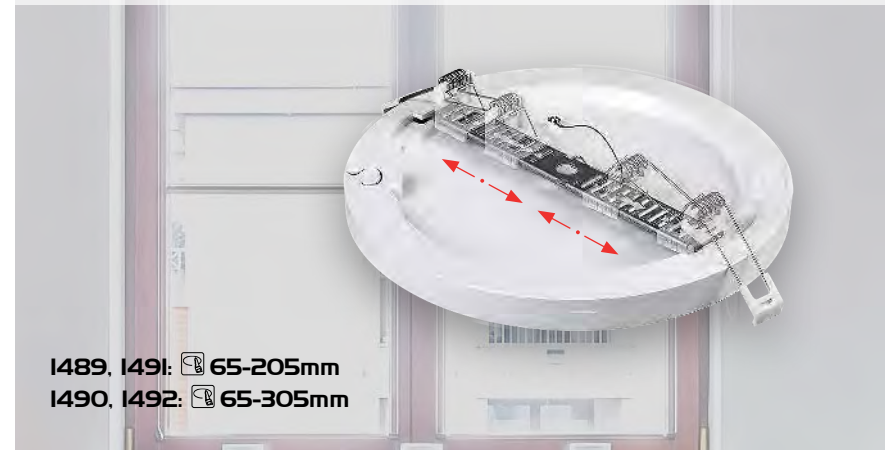

1489, 1491: 65-205mm
1490, 1492: 65-305mm

2484 (M)

⊗ E27 / 1x max. 60W
IP20
matte white



5 998250 324845

2485 (M)

⊗ E27 / 1x max. 60W
IP20
grey



5 998250 324852

2486 (M)

⊗ E27 / 1x max. 60W
IP20
matte white



5 998250 324869

2487 (M)

⊗ E27 / 1x max. 60W
IP20
grey



5 998250 324876

1489 (MP)

⊗ LED / 18W
(1500lm, 4000K) incl.
IP20 • white
65-205mm • 70mm



5 998250 314891

1490 (MP)

⊗ LED / 30W
(2800lm, 4000K) incl.
IP20 • white
65-305mm • 70mm



5 998250 314907

1491 (MP)

⊗ LED / 18W
(1500lm, 4000K) incl.
IP20 • white • 8m, 130°
65-205mm • 70mm



5 998250 314914

1492 (MP)

⊗ LED / 30W
(2800lm, 4000K) incl.
IP20 • white • 8m, 130°
65-305mm • 70mm



5 998250 314921



OLEG

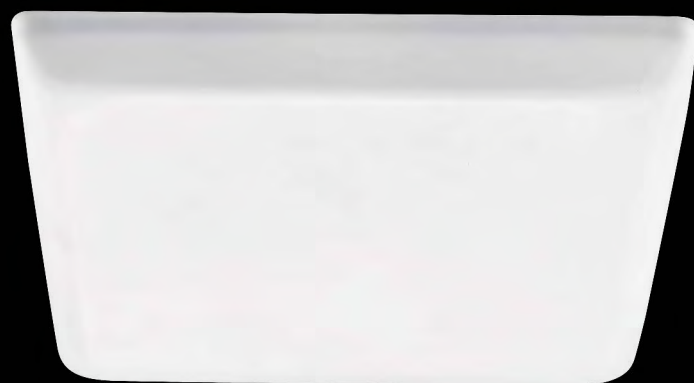

5371

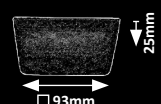

5373

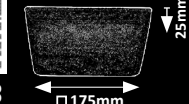

5372

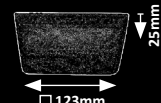

5374

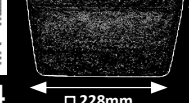

OLEG



5367

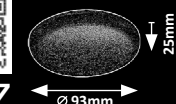

5369

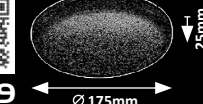

5368

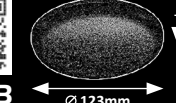

5370

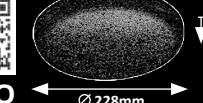

5371 (MP)

LED / 7W
(714lm, 4000K) incl.
IP65/IP20 • white
75mm



5 998250 353715

5372 (MP)

LED / 12W
(1272lm, 4000K) incl.
IP65/IP20 • white
125mm



5 998250 353722

5373 (MP)

LED / 18W
(1890lm, 4000K) incl.
IP65/IP20 • white
185mm



5 998250 353739

5374 (MP)

LED / 24W
(2568lm, 4000K) incl.
IP65/IP20 • white
245mm



5 998250 353746

5367 (MP)

LED / 7W
(714lm, 4000K) incl.
IP65/IP20 • white
73mm



5 998250 353678

5368 (MP)

LED / 12W
(1272lm, 4000K) incl.
IP65/IP20 • white
107mm



5 998250 353685

5369 (MP)

LED / 18W
(1890lm, 4000K) incl.
IP65/IP20 • white
140mm



5 998250 353692

5370 (MP)

LED / 24W
(2568lm, 4000K) incl.
IP65/IP20 • white
205mm



5 998250 353708

SHAUN

5 YEARS GUARANTEE
LED built-in
NATURAL White
F A G
NEW

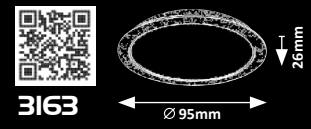

3163

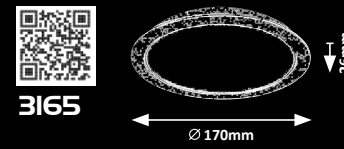

3165

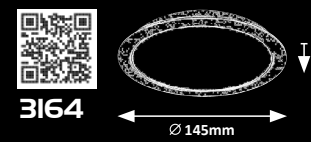

3164

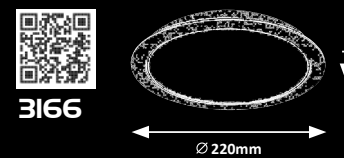

3166

3163 (P)

LED / 5W
(450lm, 4000K) incl.
IP20 • 26mm
white



5 998250 331638

3164 (P)

LED / 12W
(1300lm, 4000K) incl.
IP20 • 26mm
white



5 998250 331645

3165 (P)

LED / 18W
(1845lm, 4000K) incl.
IP20 • 26mm
white



5 998250 331652

3166 (P)

LED / 24W
(2400lm, 4000K) incl.
IP20 • 26mm
white



5 998250 331669

SHAUN

5 YEARS GUARANTEE
LED built-in
NATURAL White
F A G
NEW

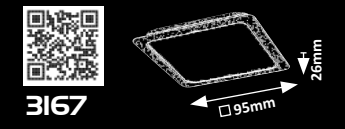

3167

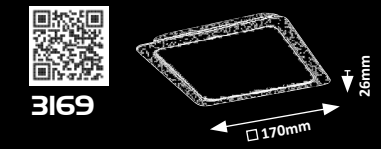

3169

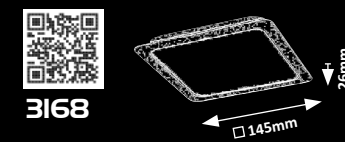

3168

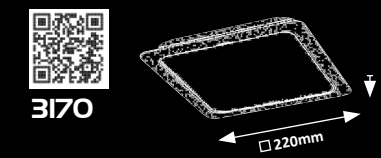

3170

3167 (P)

LED / 5W
(450lm, 4000K) incl.
IP20 • 26mm
white



5 998250 331676

3168 (P)

LED / 12W
(1300lm, 4000K) incl.
IP20 • 26mm
white



5 998250 331683

3169 (P)

LED / 18W
(1845lm, 4000K) incl.
IP20 • 26mm
white



5 998250 331690

3170 (P)

LED / 24W
(2400lm, 4000K) incl.
IP20 • 26mm
white



5 998250 331706

SHAUN





NEW



3171

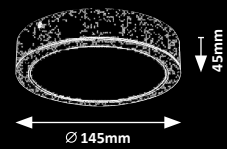

3172

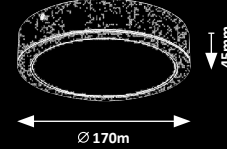

3173

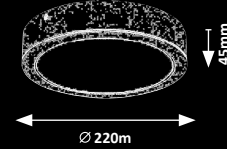

3174

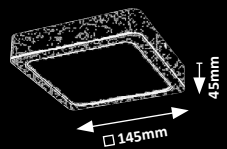

3175

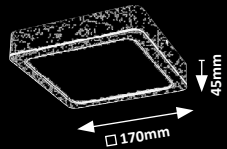

3176

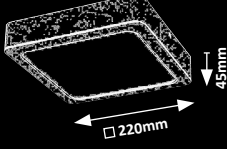

3171

(P)

 LED / 12W
 (1300lm, 4000K) incl.
 IP20
 white



3172

(P)

 LED / 18W
 (1845lm, 4000K) incl.
 IP20
 white



3173

(P)

 LED / 24W
 (2400lm, 4000K) incl.
 IP20
 white



3174

(P)

 LED / 12W
 (1300lm, 4000K) incl.
 IP20
 white



3175

(P)

 LED / 18W
 (1845lm, 4000K) incl.
 IP20
 white



3176

(P)

 LED / 24W
 (2400lm, 4000K) incl.
 IP20
 white

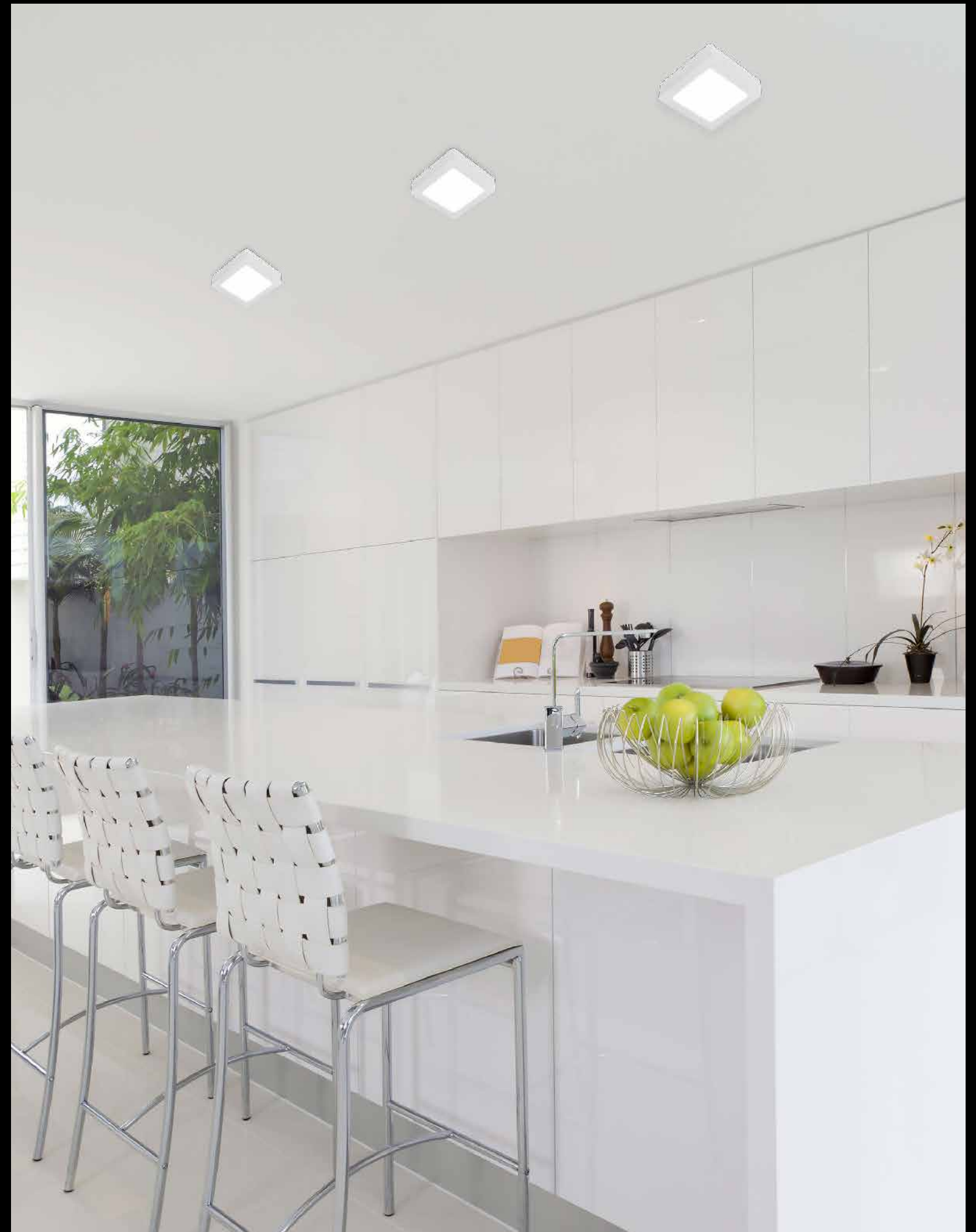



LOIS

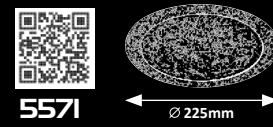
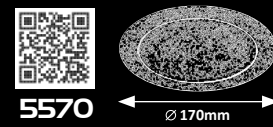
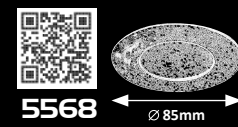

5568 (MP)

LED / 3W
(170lm, 4000K) incl.
IP20 • matte white
76mm • 25mm



5569 (MP)

LED / 6W
(350lm, 4000K) incl.
IP20 • matte white
106mm • 25mm



5570 (MP)

LED / 12W
(800lm, 4000K) incl.
IP20 • matte white
155mm • 25mm



5571 (MP)

LED / 18W
(1400lm, 4000K) incl.
IP20 • matte white
210mm • 25mm



LOIS



5576 (MP)

LED / 3W
(170lm, 4000K) incl.
IP20 • matte white
70mm • 25mm



5577 (MP)

LED / 6W
(350lm, 4000K) incl.
IP20 • matte white
106mm • 25mm



5578 (MP)

LED / 12W
(800lm, 4000K) incl.
IP20 • matte white
155mm • 25mm



5579 (MP)

LED / 18W
(1400lm, 4000K) incl.
IP20 • matte white
205mm • 25mm

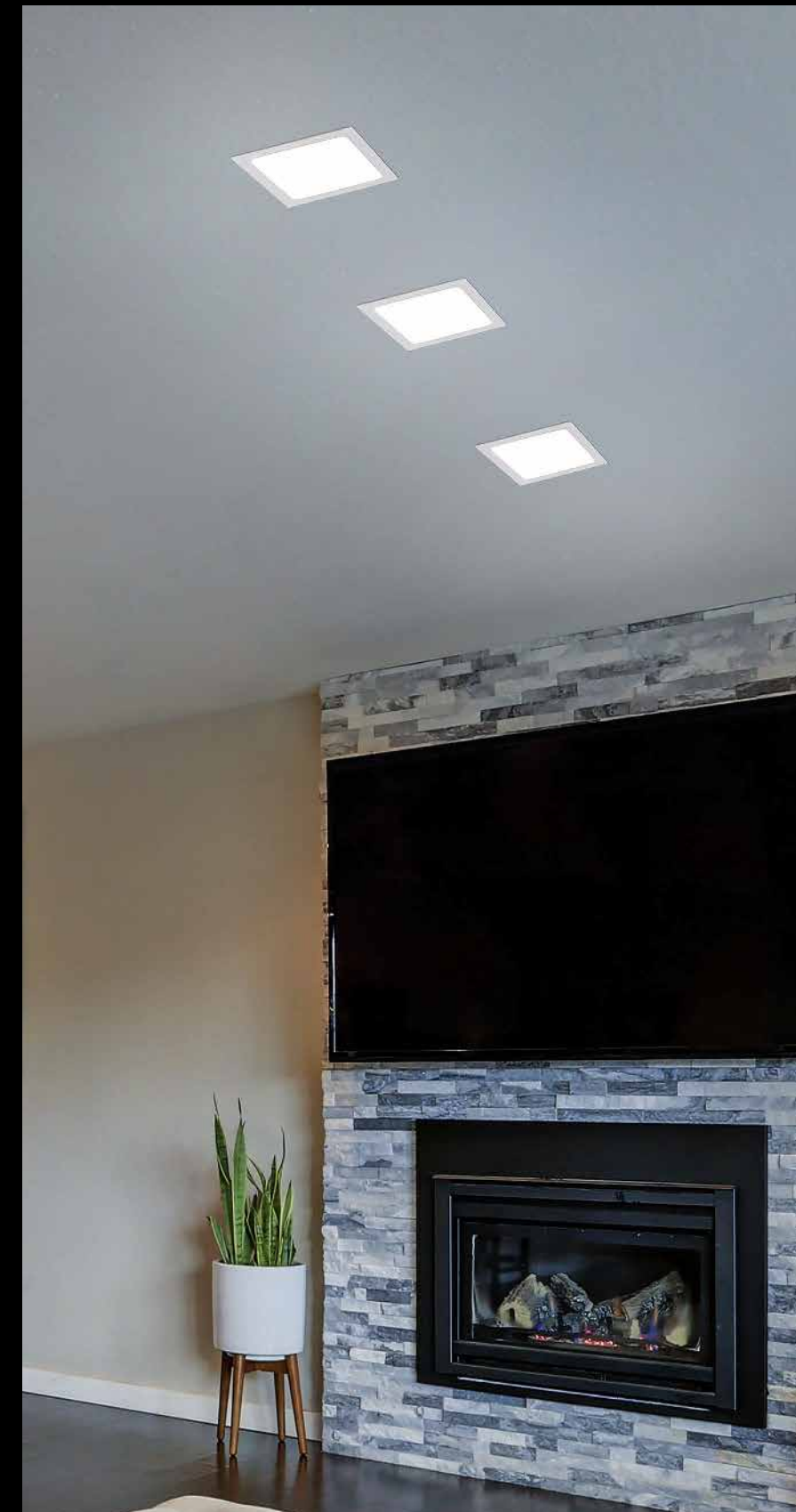



LOIS

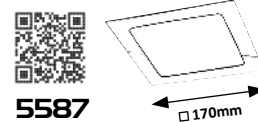
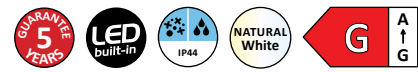

LOIS

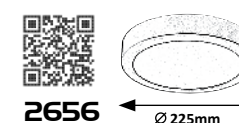
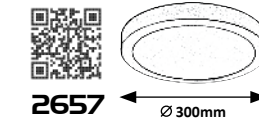

5584 (MP)

LED / 3W
(170lm, 4000K) incl.
IP44 • chrome/white
76mm • 30mm



5 998250 355849

5585 (MP)

LED / 12W
(800lm, 4000K) incl.
IP44 • chrome/white
155mm • 30mm



5 998250 355856

5586 (MP)

LED / 3W
(170lm, 4000K) incl.
IP44 • chrome/white
76mm • 30mm



5 998250 355863

5587 (MP)

LED / 12W
(800lm, 4000K) incl.
IP44 • chrome/white
155mm • 25mm



5 998250 355870

2655 (MP)

LED / 12W
(800lm, 4000K) incl.
IP20
matte white



5 998250 326559

2656 (MP)

LED / 18W
(1400lm, 4000K) incl.
IP20
matte white



5 998250 326566

2657 (MP)

LED / 24W
(1700lm, 4000K) incl.
IP20
matte white



5 998250 326573

2658 (MP)

LED / 36W
(2500lm, 4000K) incl.
IP20
matte white



5 998250 326580



LOIS



2659

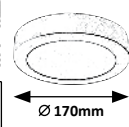

2661

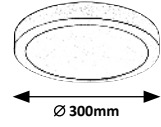

2660

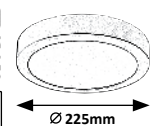

2662

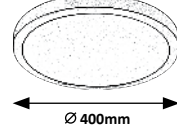

2663

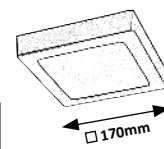

2664

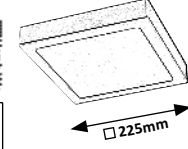

LOIS



2665

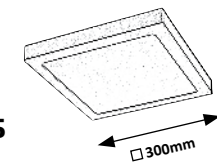

2666

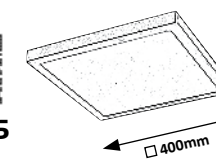

2667

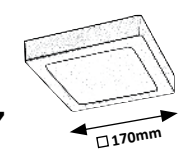

2669

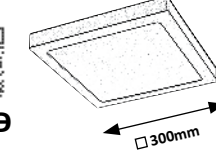

2668

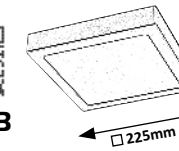

2670

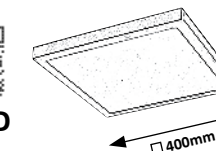

<p>2659 (MP)</p> <p>LED / 12W (800lm, 3000K) incl. IP20 satin chrome/white</p> <p>5 998250 326597</p>	<p>2660 (MP)</p> <p>LED / 18W (1400lm, 3000K) incl. IP20 satin chrome/white</p> <p>5 998250 326603</p>	<p>2661 (MP)</p> <p>LED / 24W (1700lm, 3000K) incl. IP20 satin chrome/white</p> <p>5 998250 326610</p>	<p>2662 (MP)</p> <p>LED / 36W (2500lm, 3000K) incl. IP20 satin chrome/white</p> <p>5 998250 326627</p>	<p>2663 (MP)</p> <p>LED / 12W (800lm, 4000K) incl. IP20 matte white</p> <p>5 998250 326634</p>	<p>2664 (MP)</p> <p>LED / 18W (1400lm, 4000K) incl. IP20 matte white</p> <p>5 998250 326641</p>
--	---	---	---	---	--

<p>2665 (MP)</p> <p>LED / 24W (1700lm, 4000K) incl. IP20 matte white</p> <p>5 998250 326658</p>	<p>2666 (MP)</p> <p>LED / 36W (2500lm, 4000K) incl. IP20 matte white</p> <p>5 998250 326665</p>	<p>2667 (MP)</p> <p>LED / 12W (800lm, 3000K) incl. IP20 satin chrome/white</p> <p>5 998250 326672</p>	<p>2668 (MP)</p> <p>LED / 18W (1400lm, 3000K) incl. IP20 satin chrome/white</p> <p>5 998250 326689</p>	<p>2669 (MP)</p> <p>LED / 24W (1700lm, 3000K) incl. IP20 satin chrome/white</p> <p>5 998250 326696</p>	<p>2670 (MP)</p> <p>LED / 36W (2500lm, 3000K) incl. IP20 satin chrome/white</p> <p>5 998250 326702</p>
--	--	--	---	---	---



LITE

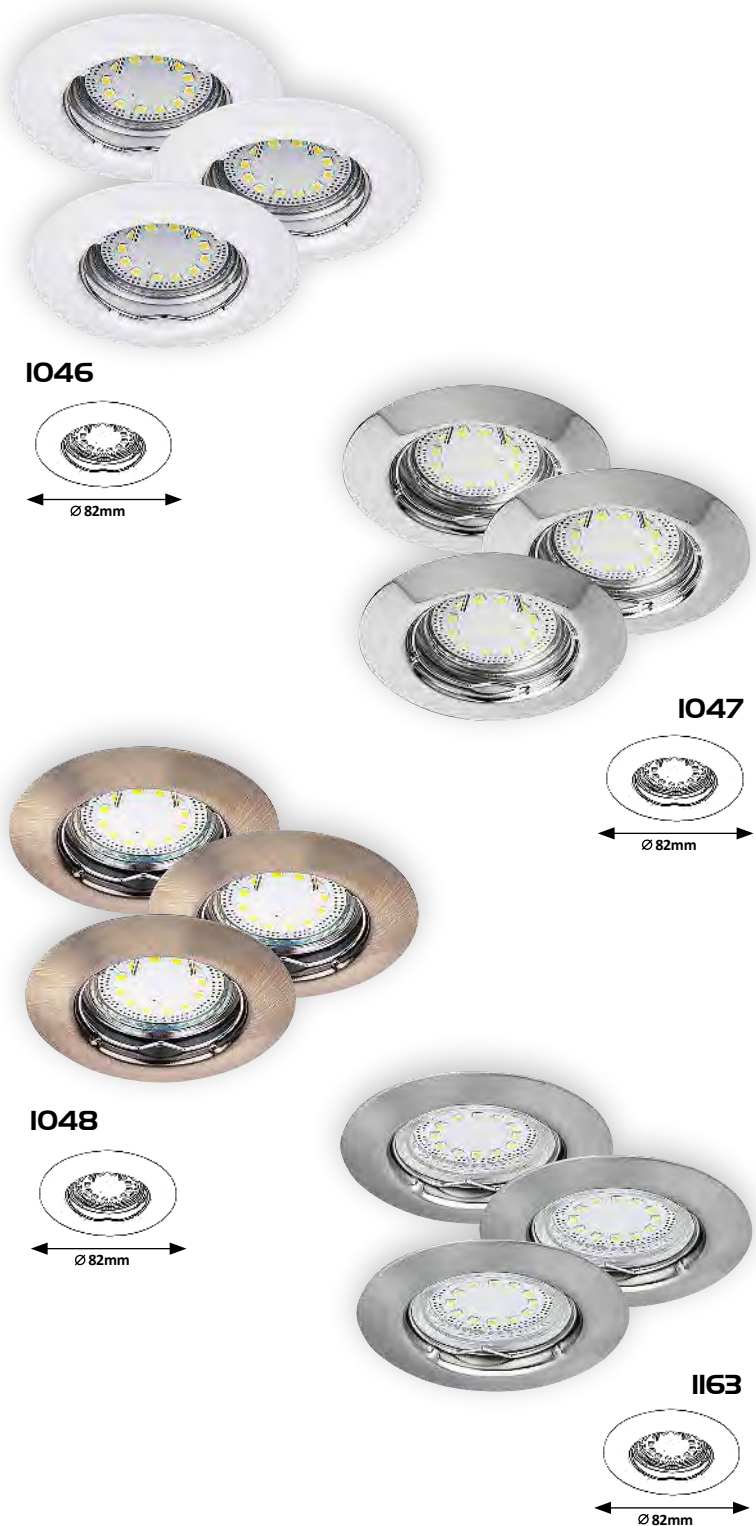
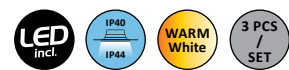

LITE

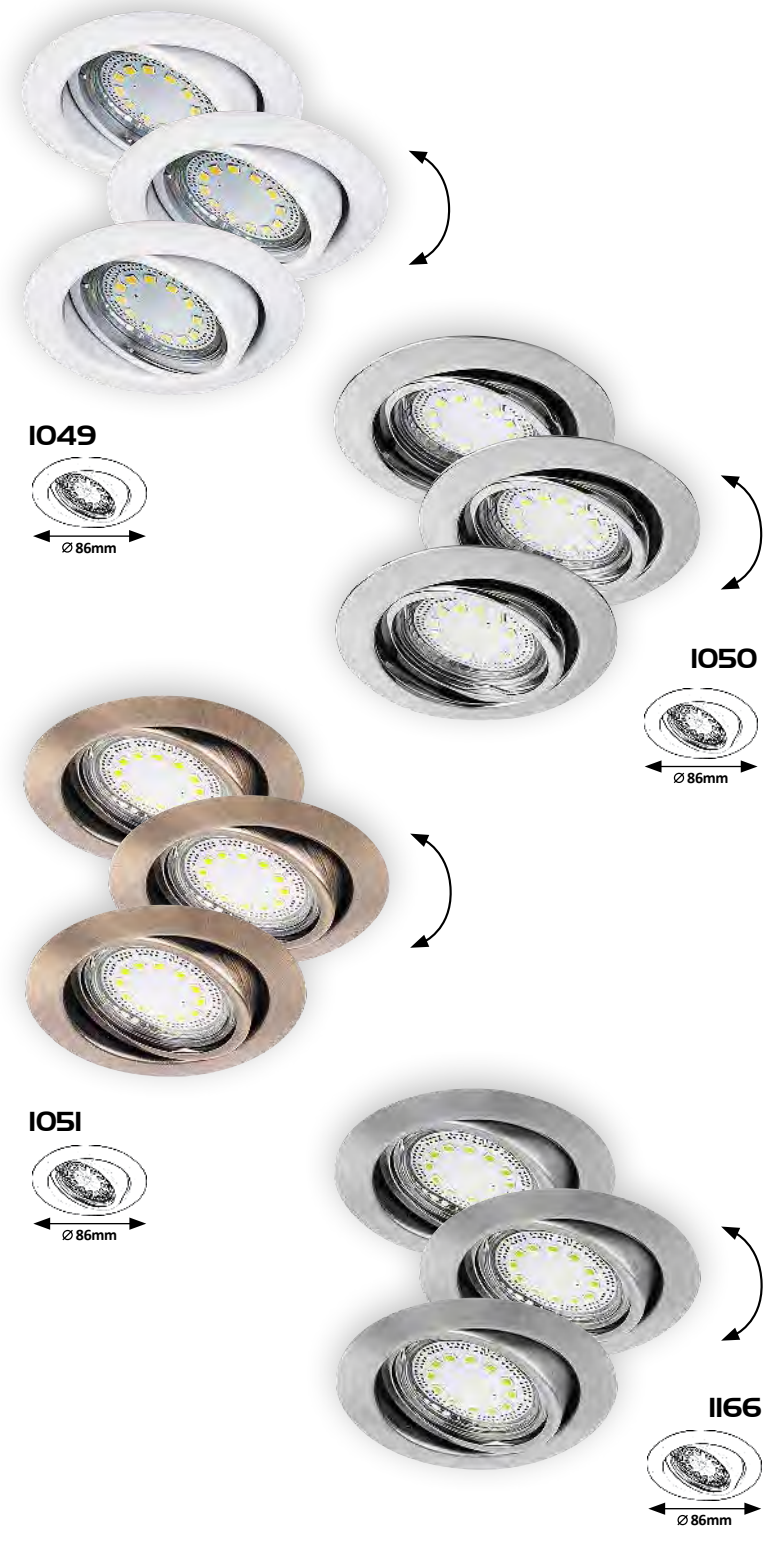

IO46 **M**
 LED / 3W (240lm, 3000K) incl.
 GU10 / 1x max. 50W
 IP44/IP40 • white
 68mm • 65mm
 5 998250 310466

IO47 **M**
 LED / 3W (240lm, 3000K) incl.
 GU10 / 1x max. 50W
 IP44/IP40 • chrome
 68mm • 65mm
 5 998250 310473

IO48 **M**
 LED / 3W (240lm, 3000K) incl.
 GU10 / 1x max. 50W
 IP44/IP40 • bronze
 68mm • 65mm
 5 998250 310480

IO49 **M**
 LED / 3W (240lm, 3000K) incl.
 GU10 / 1x max. 50W
 IP44/IP40 • satin chrome
 68mm • 65mm
 5 998250 311636

IO49 **M**
 LED / 3W (240lm, 3000K) incl.
 GU10 / 1x max. 50W
 IP40 • white
 72mm • 60mm
 5 998250 310497

IO50 **M**
 LED / 3W (240lm, 3000K) incl.
 GU10 / 1x max. 50W
 IP40 • chrome
 72mm • 60mm
 5 998250 310503

IO51 **M**
 LED / 3W (240lm, 3000K) incl.
 GU10 / 1x max. 50W
 IP40 • bronze
 72mm • 60mm
 5 998250 310510

IO52 **M**
 LED / 3W (240lm, 3000K) incl.
 GU10 / 1x max. 50W
 IP40 • satin chrome
 72mm • 65mm
 5 998250 311661

SPOT RELIGHT



1087 **M**
 ☒ GU 5.3 / 12V / 1x max. 50W
 IP20 • white
 ☒ 68mm • ↓ 35mm



5 998250 310879

1088 **M**
 ☒ GU 5.3 / 12V / 1x max. 50W
 IP20 • chrome
 ☒ 68mm • ↓ 35mm



5 998250 310886

1089 **M**
 ☒ GU 5.3 / 12V / 1x max. 50W
 IP20 • satin chrome
 ☒ 68mm • ↓ 35mm



5 998250 310893

1090 **M**
 ☒ GU 5.3 / 12V / 1x max. 50W
 IP20 • bronze
 ☒ 68mm • ↓ 35mm



5 998250 310909

SPOT RELIGHT

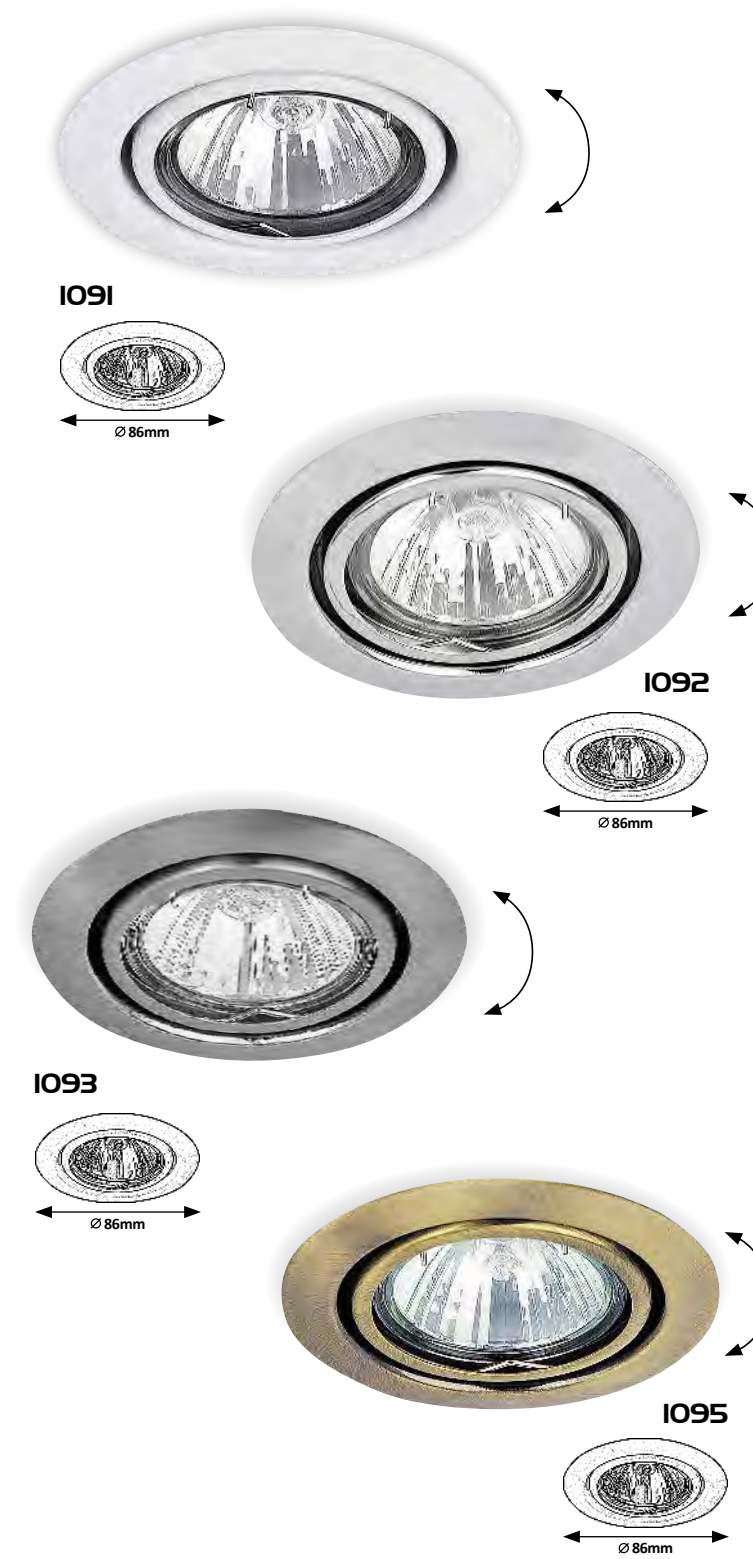

1091 **M**
 ☒ GU 5.3 / 12V / 1x max. 50W
 IP20 • white
 ☒ 72mm • ↓ 35mm



5 998250 310916

1092 **M**
 ☒ GU 5.3 / 12V / 1x max. 50W
 IP20 • chrome
 ☒ 72mm • ↓ 35mm



5 998250 310923

1093 **M**
 ☒ GU 5.3 / 12V / 1x max. 50W
 IP20 • satin chrome
 ☒ 72mm • ↓ 35mm



5 998250 310930

1095 **M**
 ☒ GU 5.3 / 12V / 1x max. 50W
 IP20 • bronze
 ☒ 72mm • ↓ 35mm



5 998250 310954

RANDY



I072 (P)
 LED / 4W
 (350lm, 3000K) incl.
 IP20/IP44 • chrome
 68mm • 40mm

 5 998250 310725

I078 (P)
 LED / 4W
 (350lm, 3000K) incl.
 IP20/IP44 • white
 68mm • 40mm

 5 998250 310787

I079 (P)
 LED / 4W
 (350lm, 3000K) incl.
 IP20/IP44 • chrome
 68mm • 40mm

 5 998250 310794

I080 (P)
 LED / 4W
 (350lm, 3000K) incl.
 IP20/IP44 • white
 68mm • 40mm

 5 998250 310800

SPOT FASHION



I116 (M)
 GU 5.3 / 12V /
 1x max. 50W
 IP20 • brushed aluminium
 70mm • 30mm

 5 998250 311166

I117 (M)
 GU 5.3 / 12V /
 1x max. 50W
 IP20 • brushed aluminium
 70mm • 30mm

 5 998250 311173

I120 (M, AC)
 GU 5.3 / 12V /
 1x max. 50W
 IP20 • chrome/transparent
 60mm • 25mm

 5 998250 311203

I147 (M, G)
 GU 5.3 / 12V /
 1x max. 50W
 IP20 • chrome
 60mm • 30mm

 5 998250 3111470

I148 (M, G)
 GU 5.3 / 12V /
 1x max. 50W
 IP20 • chrome
 55mm • 30mm

 5 998250 311487

I160 (M, AC)
 GU 5.3 / 12V /
 1x max. 50W
 IP20 • chrome/transparent
 52mm • 25mm

 5 998250 311609



12

OUTDOOR LAMPS

KÜLTÉRI LÁMPÁK

AUSSENLEUCHTEN



TAVERNA



7127

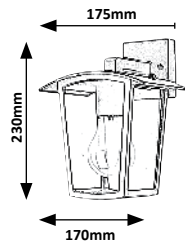

7130

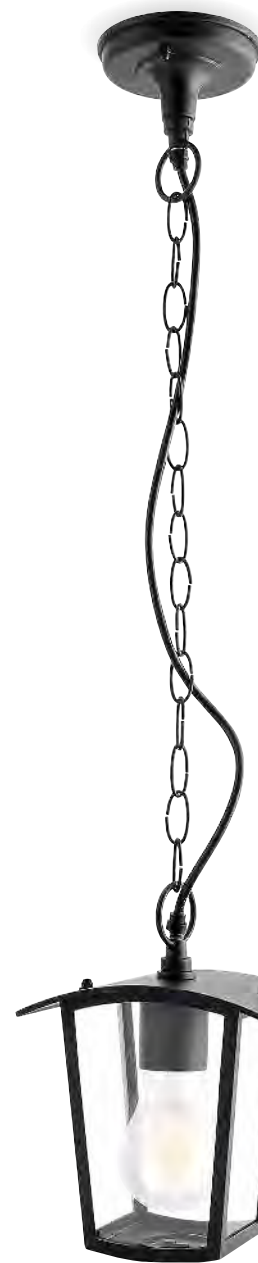
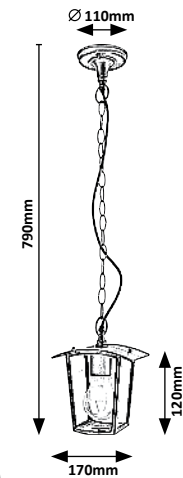

7128

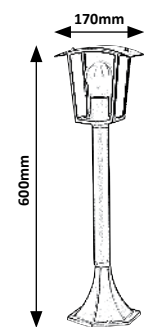

7129

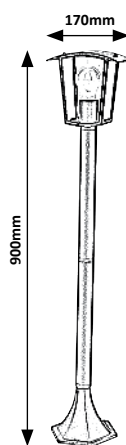

7127 (M P)

⊗ E27 / 1x max. 15W
IP44 • 19983
black/transparent



5 998250 371276

7128 (M P)

⊗ E27 / 1x max. 15W
IP44 • 19983
black/transparent



5 998250 371283

7129 (M P)

⊗ E27 / 1x max. 15W
IP44 • 19983
black/transparent



5 998250 371290

7130 (M P)

⊗ E27 / 1x max. 15W
IP44 • 19983
black/transparent



5 998250 371306

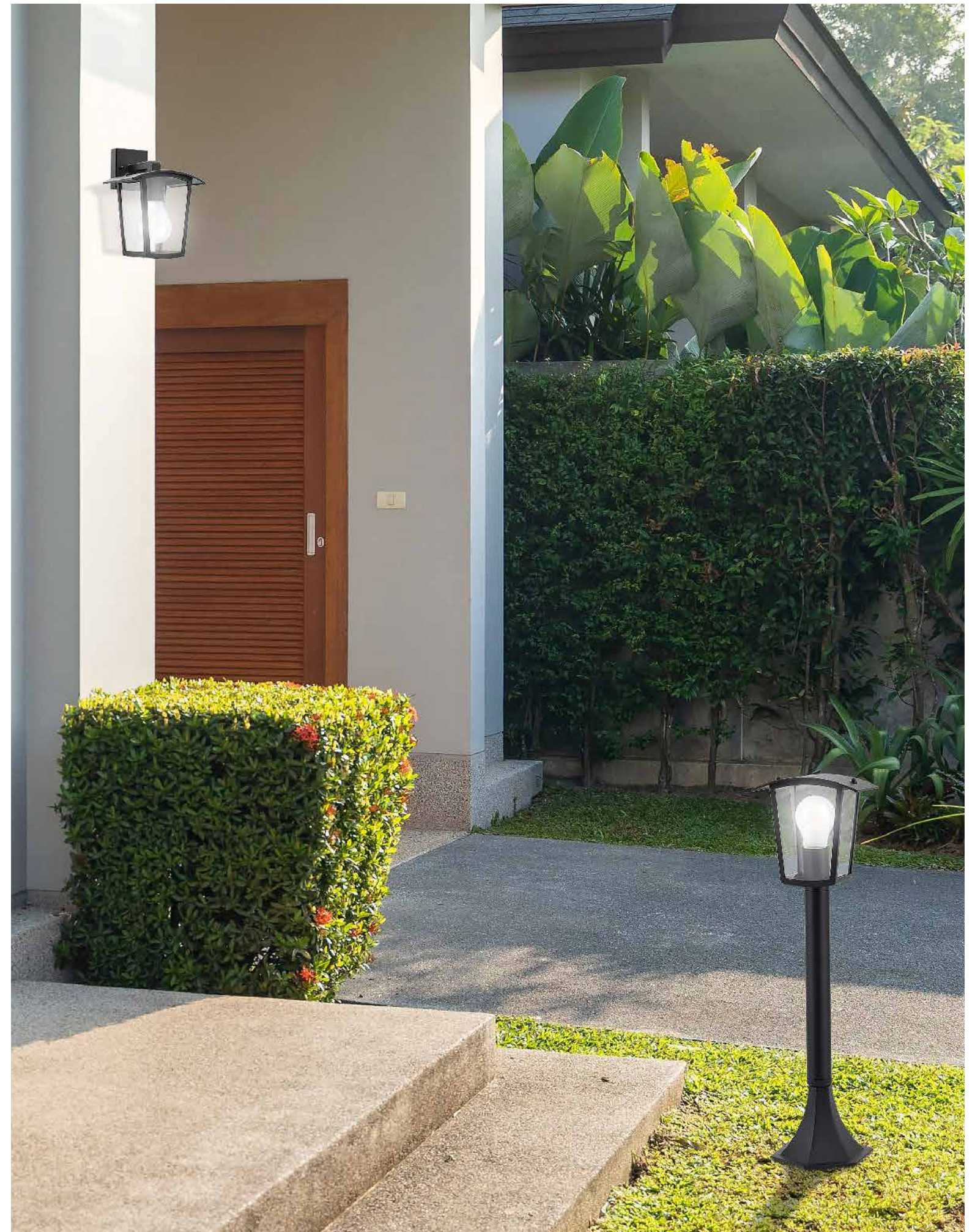



ALMADA



DARRINGTON



7884 (M) (P)

☒ E27 / 1x max. 10W
 IP44 • 19855
 brown/transparent



5 998250 378848

7885 (M) (P)

☒ E27 / 1x max. 10W
 IP44 • 19855
 brown/transparent



5 998250 378855

7886 (M) (P)

☒ E27 / 1x max. 10W
 IP44 • 19855
 brown/transparent



5 998250 378862

7677 (M) (G)

☒ E27 / 1x max. 20W
 IP44
 19638
 black/white



5 998250 376776

7678 (M) (G)

☒ E27 / 1x max. 20W
 IP44
 19638
 black/white



5 998250 376783

7679 (M) (G)

☒ E27 / 1x max. 20W
 IP44 • 6m, 90°
 19638
 black/white



5 998250 376790

7680 (M) (G)

☒ E27 / 1x max. 20W
 IP44
 19638
 black/white



5 998250 376806



BUDAPEST



8888

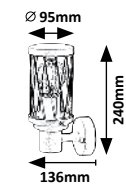

8889

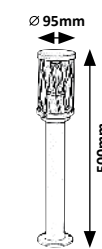

8890

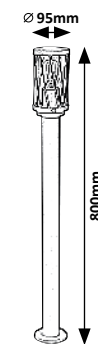

PESCARA



8757

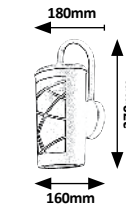

8759

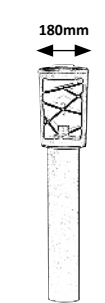

8888 (M) (P)

☒ E27 / 1x max. 40W
IP44
brown/transparent



5 998250 388885

8889 (M) (P)

☒ E27 / 1x max. 40W
IP44
brown/transparent



5 998250 388892

8890 (M) (P)

☒ E27 / 1x max. 40W
IP44
brown/transparent



5 998250 388908

8757 (M) (P)

☒ E27 / 1x max. 60W
IP44
brown/rust effect/opal glass



5 998250 387574

8759 (M) (P)

☒ E27 / 1x max. 60W
IP44
brown/rust effect/opal glass



5 998250 387598



MONACO

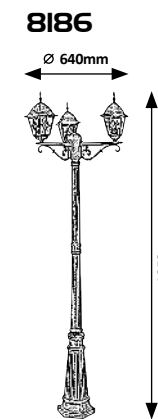
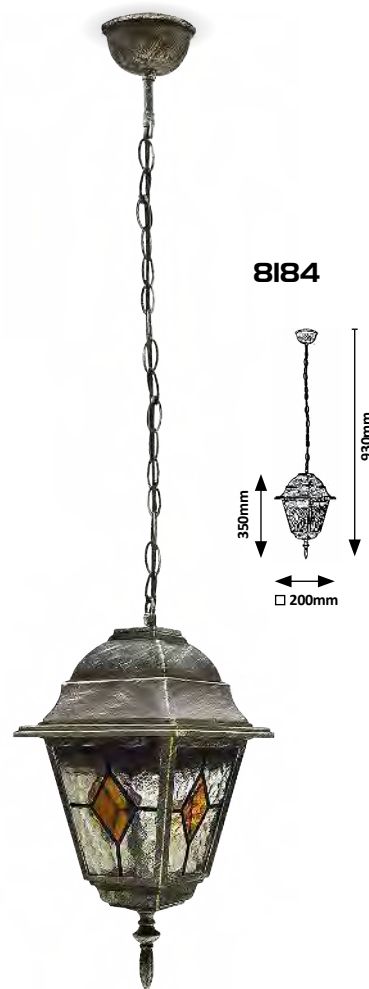
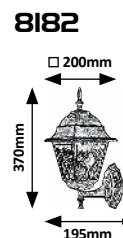

8181 M G

☒ E27 / 1x max. 60W
IP43 • 19053
antique gold/transparent/
orange



5 998250 381817

8182 M G

☒ E27 / 1x max. 60W
IP43 • 19053
antique gold/transparent/
orange



5 998250 381824

8183 M G

☒ E27 / 1x max. 60W
IP43 • 19053
antique gold/transparent/
orange



5 998250 381831

8184 M G

☒ E27 / 1x max. 60W
IP43 • 19053
antique gold/transparent/
orange



5 998250 381848

8185 M G

☒ E27 / 1x max. 60W
IP43 • 19053
antique gold/transparent/
orange



5 998250 381855

8186 M G

☒ E27 / 3x max. 60W
IP43 • 19053
antique gold/transparent/
orange



5 998250 381862

TORONTO



8380

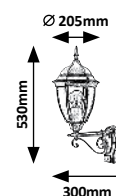

8381

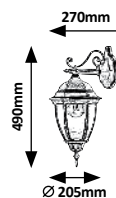

8382

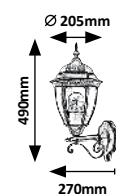

8383

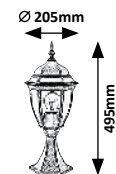

8380 MG

☒ E27 / 1x max. 60W
IP44 • 9801
☒ 8m, 100°
antique gold/transparent



5 998250 383804

8381 MG

☒ E27 / 1x max. 60W
IP44 • 9801
antique gold/transparent



5 998250 383811

8382 MG

☒ E27 / 1x max. 60W
IP44 • 9801
antique gold/transparent



5 998250 383828

8383 MG

☒ E27 / 1x max. 60W
IP44 • 9801
antique gold/transparent



5 998250 383835

TORONTO

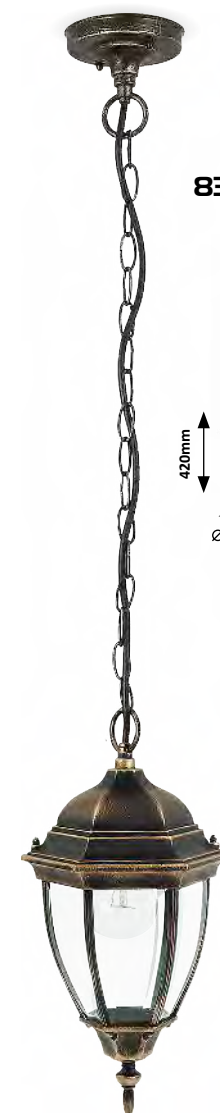

8384

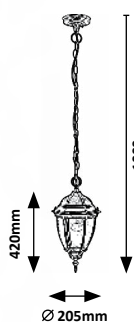

8385

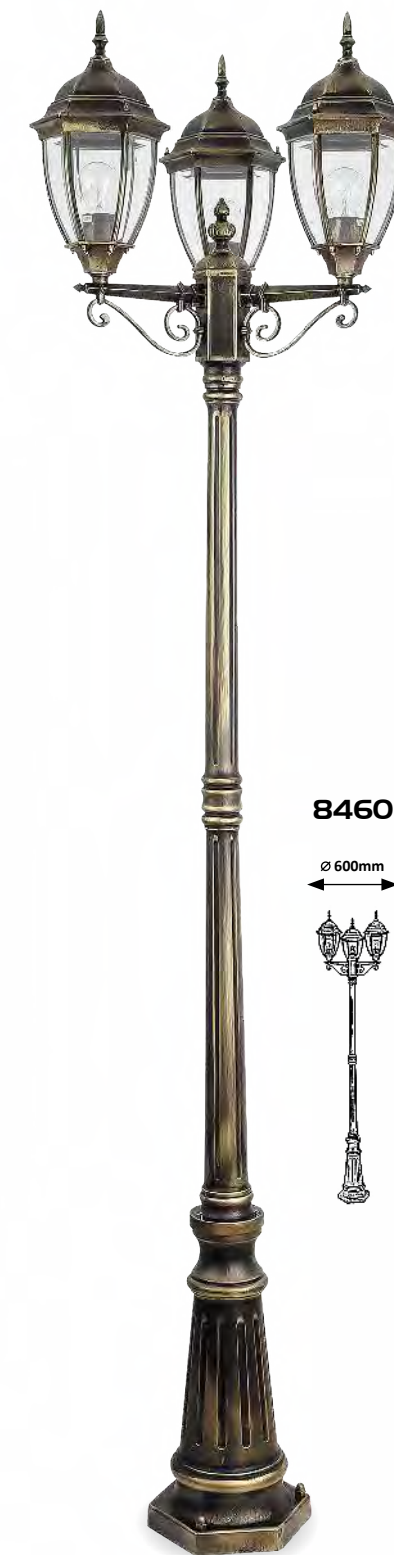
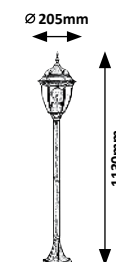

8460



8384 MG

☒ E27 / 1x max. 60W
IP44 • 9801
antique gold/transparent



5 998250 383842

8385 MG

☒ E27 / 1x max. 60W
IP44 • 9801
antique gold/transparent



5 998250 383859

8460 MG

☒ E27 / 3x max. 60W
IP44 • 9801
antique gold/transparent



5 998250 384603



NIZZA



8451

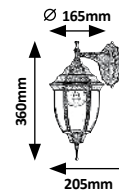

8453



8452

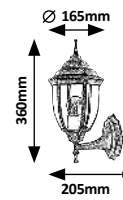

8458

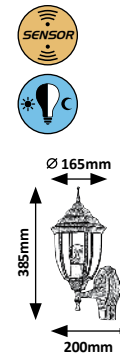

8455

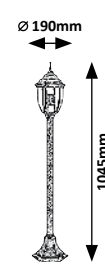

8454

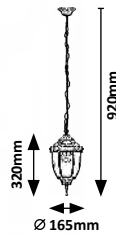

8451 **MG**

☒ E27 / 1x max. 60W
IP43 • 9837
antique gold/transparent



5 998250 384511

8452 **MG**

☒ E27 / 1x max. 60W
IP43 • 9837
antique gold/transparent



5 998250 384528

8453 **MG**

☒ E27 / 1x max. 60W
IP43 • 9837
antique gold/transparent



5 998250 384535

8454 **MG**

☒ E27 / 1x max. 60W
IP43 • 9837
antique gold/transparent



5 998250 384542

8455 **MG**

☒ E27 / 1x max. 60W
IP43 • 9837
antique gold/transparent



5 998250 384559

8458 **MG**

☒ E27 / 1x max. 60W
IP43 • 9837
8m, 120°
antique gold/transparent



5 998250 384580



TOSCANA



8396

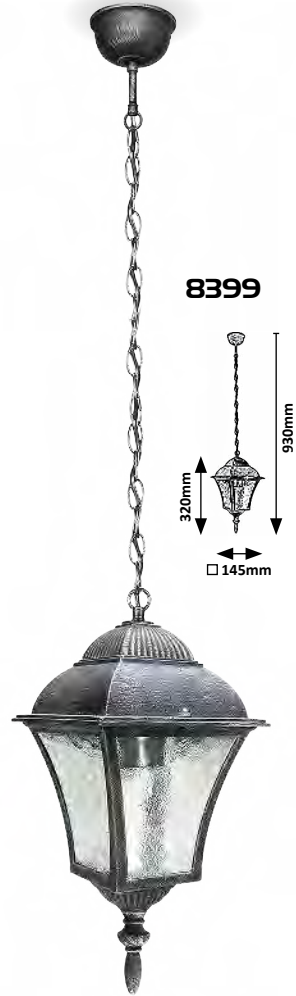
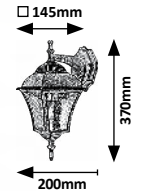

8399

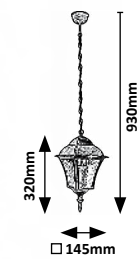

8397

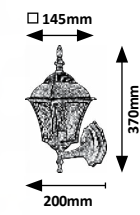

8398

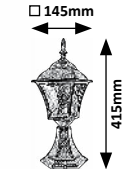

8400

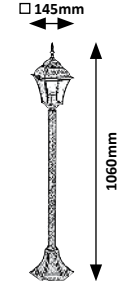

TOSCANA



8391

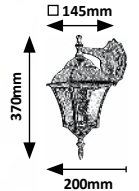

8392

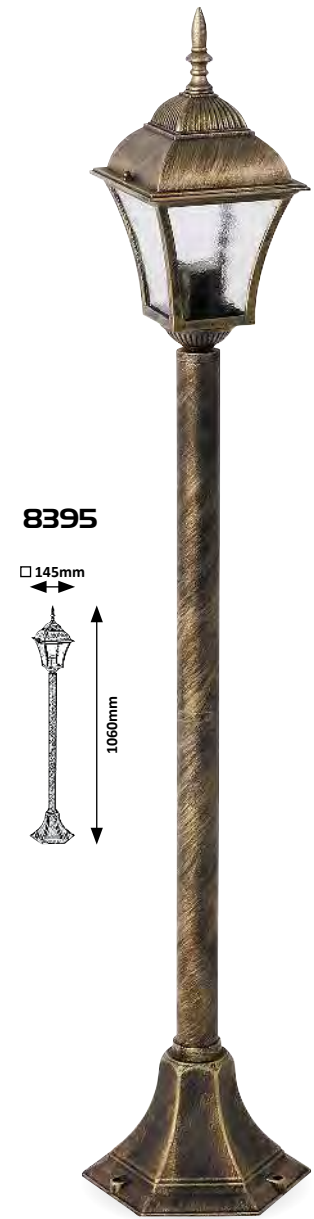

8395

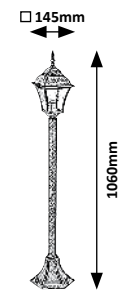

8393

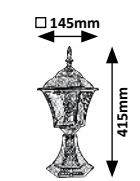

8394

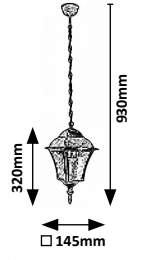

8396 MG

☒ E27 / 1x max. 60W
IP43 • 19052
antique silver/transparent



5 998250 383965

8397 MG

☒ E27 / 1x max. 60W
IP43 • 19052
antique silver/transparent



5 998250 383972

8398 MG

☒ E27 / 1x max. 60W
IP43 • 19052
antique silver/transparent



5 998250 383989

8399 MG

☒ E27 / 1x max. 60W
IP43 • 19052
antique silver/transparent



5 998250 383996

8400 MG

☒ E27 / 1x max. 60W
IP43 • 19052
antique silver/transparent



5 998250 384009

8391 MG

☒ E27 / 1x max. 60W
IP43 • 19052
antique gold/transparent



5 998250 383910

8392 MG

☒ E27 / 1x max. 60W
IP43 • 19052
antique gold/transparent



5 998250 383927

8393 MG

☒ E27 / 1x max. 60W
IP43 • 19052
antique gold/transparent



5 998250 383934

8394 MG

☒ E27 / 1x max. 60W
IP43 • 19052
antique gold/transparent



5 998250 383941

8395 MG

☒ E27 / 1x max. 60W
IP43 • 19052
antique gold/transparent



5 998250 383958

MILANO



8370

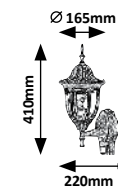

8376

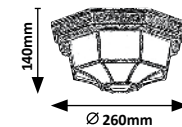

8371



8372



MILANO



8373



8374

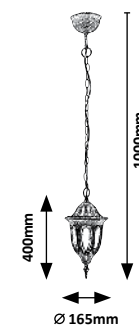

8375

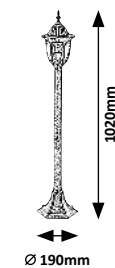

8370 MG

⊗ E27 / 1x max. 60W
IP43 • 9449
8m, 120°
antique gold/transparent



5 998250 383705

8371 MG

⊗ E27 / 1x max. 60W
IP43 • 9449
antique gold/transparent



5 998250 383712

8372 MG

⊗ E27 / 1x max. 60W
IP43 • 9449
antique gold/transparent



5 998250 383729

8376 MG

⊗ E27 / 1x max. 100W
IP43 • 9446
antique gold/opal glass



5 998250 383767

8373 MG

⊗ E27 / 1x max. 60W
IP43 • 9449
antique gold/transparent



5 998250 383736

8374 MG

⊗ E27 / 1x max. 60W
IP43 • 9449
antique gold/transparent



5 998250 383743

8375 MG

⊗ E27 / 1x max. 60W
IP43 • 9449
antique gold/transparent



5 998250 383750



MILANO



7837



8341

Ø 165mm

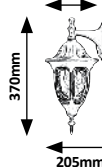

8342

Ø 165mm

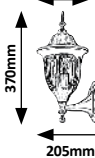

MILANO



8346

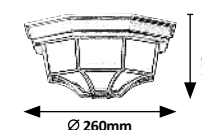

8343

Ø 165mm

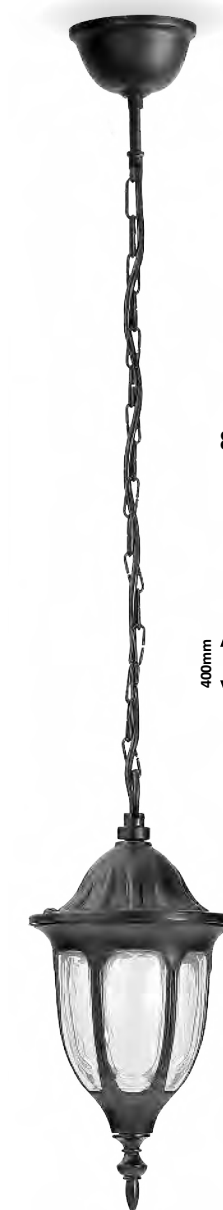

8344

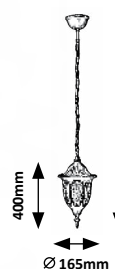

8345

Ø 190mm



7837 MG

☒ E27 / 1x max. 60W
IP43 • 9449
☒ 8m, 120°
matte black/transparent



5 998250 378374

8341 MG

☒ E27 / 1x max. 60W
IP43 • 9449
matte black/transparent



5 998250 383415

8342 MG

☒ E27 / 1x max. 60W
IP43 • 9449
matte black/transparent



5 998250 383422

8343 MG

☒ E27 / 1x max. 60W
IP43 • 9449
matte black/transparent



5 998250 383439

8344 MG

☒ E27 / 1x max. 60W
IP43 • 9449
matte black/transparent



5 998250 383446

8345 MG

☒ E27 / 1x max. 60W
IP43 • 9449
matte black/transparent



5 998250 383453

8346 MG

☒ E27 / 1x max. 100W
IP43 • 9446
matte black/transparent



5 998250 383460

VELENCE



8204
 Ø 210mm
 350mm
 230mm

8202
 Ø 210mm
 350mm
 230mm

8206
 Ø 210mm
 400mm

8208
 310mm
 950mm
 Ø 210mm

8210
 Ø 210mm
 1050mm

8217
 SENSOR
 210mm
 360mm
 230mm

VELENCE



8203
 Ø 210mm
 350mm
 230mm

8201
 Ø 210mm
 350mm
 230mm

8205
 Ø 210mm
 400mm

8207
 310mm
 950mm
 Ø 210mm

8209
 Ø 210mm
 1050mm

8216
 SENSOR
 210mm
 360mm
 230mm

- | | | | | | |
|--|--|--|--|--|--|
| 8202 MG
☒ E27 / 1x max. 60W
IP43 • 9283
black/transparent
5 998250 382029 | 8204 MG
☒ E27 / 1x max. 60W
IP43 • 9283
black/transparent
5 998250 382043 | 8206 MG
☒ E27 / 1x max. 60W
IP43 • 9283
black/transparent
5 998250 382067 | 8208 MG
☒ E27 / 1x max. 60W
IP43 • 9283
black/transparent
5 998250 382081 | 8210 MG
☒ E27 / 1x max. 60W
IP43 • 9283
black/transparent
5 998250 382104 | 8217 MG
☒ E27 / 1x max. 60W
IP43 • 9283
8m, 120°
black/transparent
5 998250 382173 |
|--|--|--|--|--|--|

- | | | | | | |
|--|--|--|--|--|--|
| 8201 MG
☒ E27 / 1x max. 60W
IP43 • 9283
white/transparent
5 998250 382012 | 8203 MG
☒ E27 / 1x max. 60W
IP43 • 9283
white/transparent
5 998250 382036 | 8205 MG
☒ E27 / 1x max. 60W
IP43 • 9283
white/transparent
5 998250 382050 | 8207 MG
☒ E27 / 1x max. 60W
IP43 • 9283
white/transparent
5 998250 382074 | 8209 MG
☒ E27 / 1x max. 60W
IP43 • 9283
white/transparent
5 998250 382098 | 8216 MG
☒ E27 / 1x max. 60W
IP43 • 9283
8m, 120°
white/transparent
5 998250 382166 |
|--|--|--|--|--|--|

VELENCE

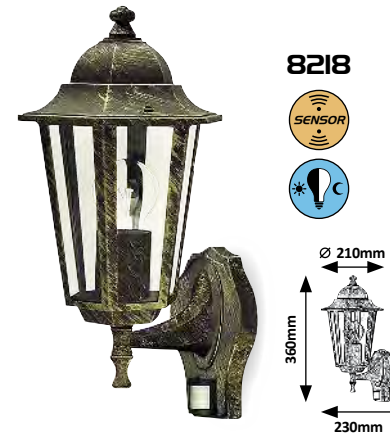

8218

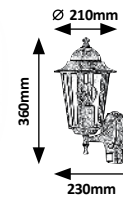

8234

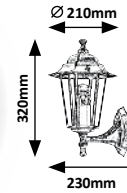

8236

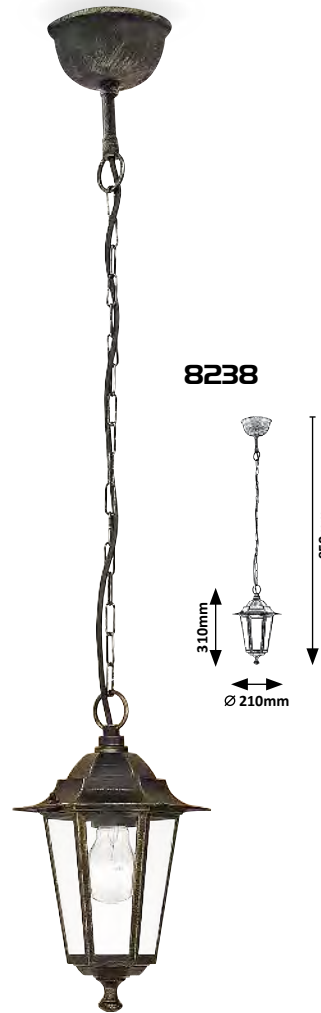
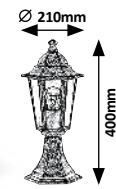

8238

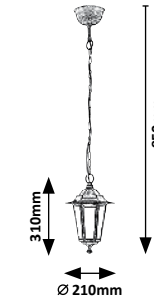

8232

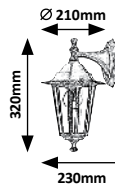

8240

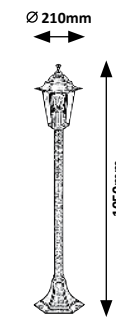

8218 M G

☒ E27 / 1x max. 60W
IP43 • 9283
8m, 120°
antique gold/transparent



8232 M G

☒ E27 / 1x max. 60W
IP43 • 9283
antique gold/transparent



8234 M G

☒ E27 / 1x max. 60W
IP43 • 9283
antique gold/transparent



8236 M G

☒ E27 / 1x max. 60W
IP43 • 9283
antique gold/transparent



8238 M G

☒ E27 / 1x max. 60W
IP43 • 9283
antique gold/transparent



8240 M G

☒ E27 / 1x max. 60W
IP43 • 9283
antique gold/transparent



MIAMI

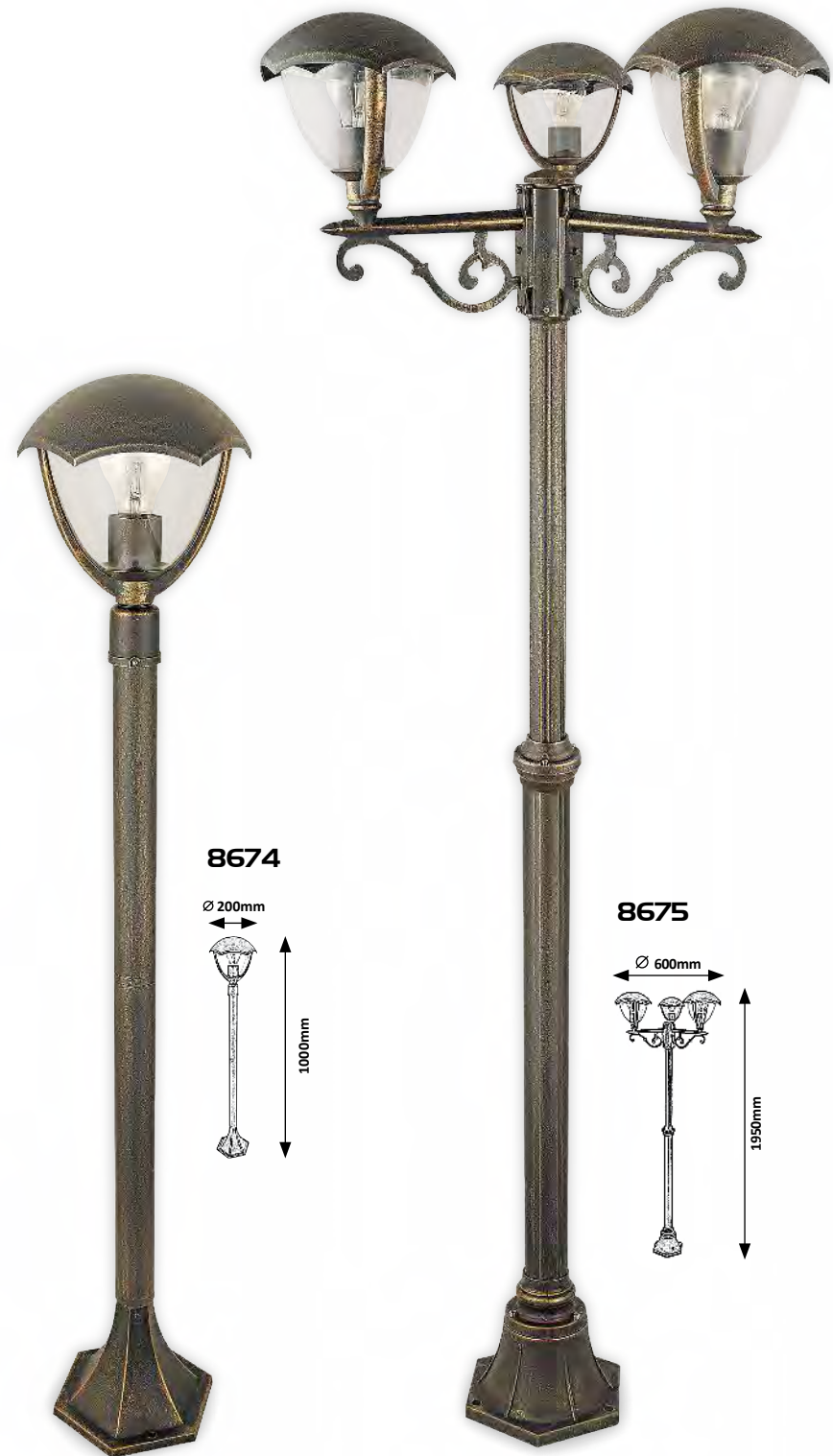

8670 (M) (P) E27 / 1x max. 40W IP44 antique gold/transparent

8671 (M) (P) E27 / 1x max. 40W IP44 antique gold/transparent

8674 (M) (P) E27 / 1x max. 40W IP44 antique gold/transparent

8675 (M) (P) E27 / 3x max. 40W IP44 antique gold/transparent

8676 (M) (P) E27 / 1x max. 40W IP44 • 0,5-12m, 140° antique gold/transparent



NEW YORK

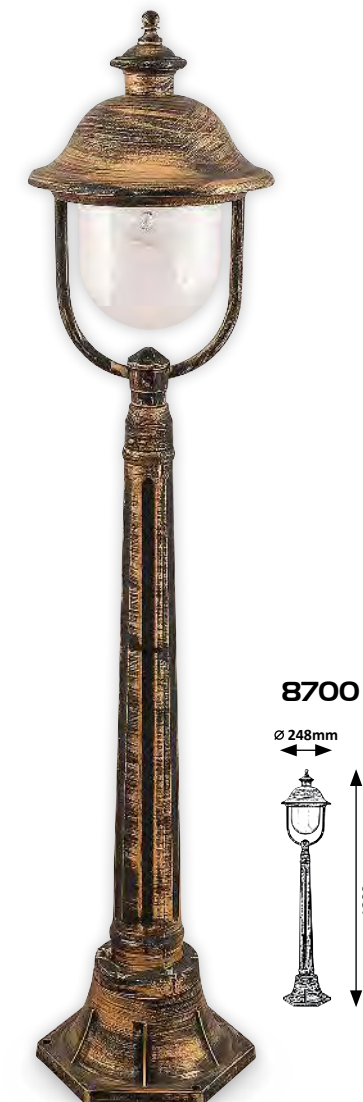

8696 (M) (P) E27 / 1x max. 100W IP44 • 19448 antique gold/transparent

8697 (M) (P) E27 / 1x max. 100W IP44 • 19448 antique gold/transparent

8698 (M) (P) E27 / 1x max. 100W IP44 • 19448 antique gold/transparent

8699 (M) (P) E27 / 1x max. 100W IP44 • 19448 antique gold/transparent

8700 (M) (P) E27 / 1x max. 100W IP44 • 19448 antique gold/transparent





ODESSA

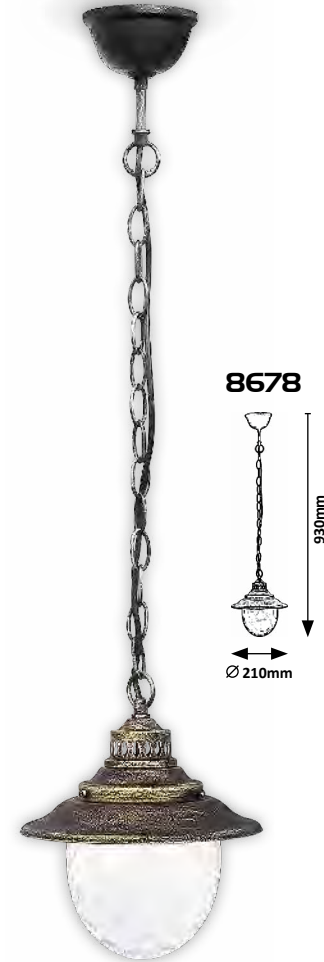
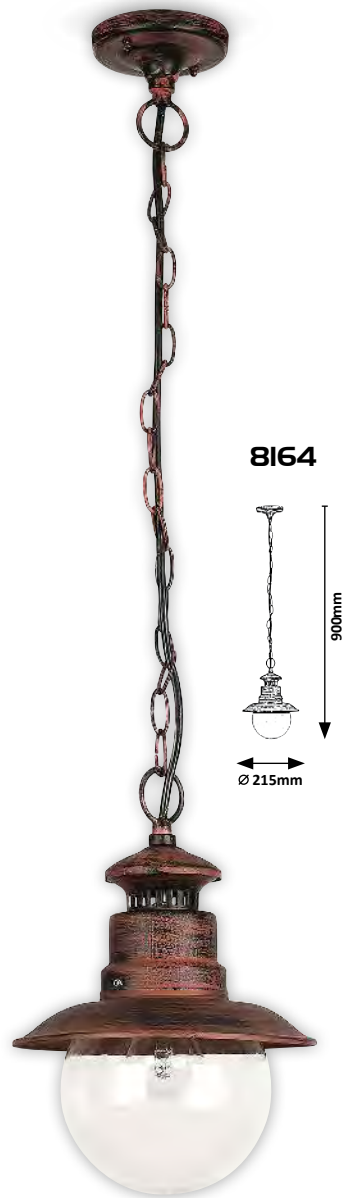

BARCELONA



8163 (M) (P)
 ☒ E27 / 1x max. 60W
 IP44 • 19447
 antique brown/transparent



8164 (M) (P)
 ☒ E27 / 1x max. 60W
 IP44 • 19447
 antique brown/transparent



8165 (M) (P)
 ☒ E27 / 1x max. 60W
 IP44 • 19447
 antique brown/transparent



8677 (M) (G)
 ☒ E27 / 1x max. 60W
 IP43 • 19375
 antique gold/transparent



8678 (M) (G)
 ☒ E27 / 1x max. 60W
 IP43 • 19375
 antique gold/transparent



8679 (M) (G)
 ☒ E27 / 1x max. 60W
 IP43 • 19375
 antique gold/transparent



MADRID



8476

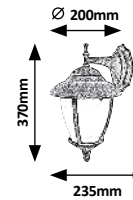

8377

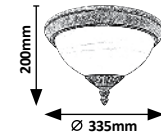

8477

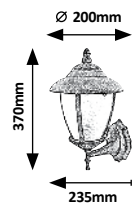

8478



7836

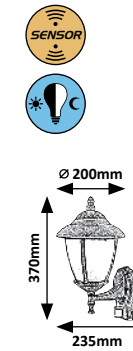

7836 MG

⊠ E27 / 1x max. 60W
IP43 • 9865
8m, 120°
antique gold/alabaster



5 998250 378367

8377 MG

⊠ E27 / 2x max. 40W
IP43 • 9866
antique gold/alabaster



5 998250 383774

8476 MG

⊠ E27 / 1x max. 60W
IP43 • 9865
antique gold/alabaster



5 998250 384764

8477 MG

⊠ E27 / 1x max. 60W
IP43 • 9865
antique gold/alabaster



5 998250 384771

8478 MG

⊠ E27 / 1x max. 60W
IP43 • 9865
antique gold/alabaster



5 998250 384788

MADRID



8479

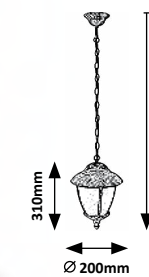

8480

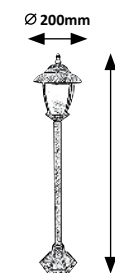

8379

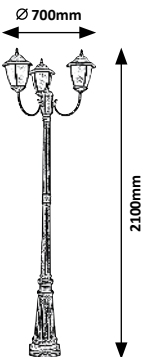

8379 MG

⊠ E27 / 3x max. 60W
IP43 • 9865
antique gold/alabaster



5 998250 383798

8479 MG

⊠ E27 / 1x max. 60W
IP43 • 9865
antique gold/alabaster



5 998250 384795

8480 MG

⊠ E27 / 1x max. 60W
IP43 • 9865
antique gold/alabaster



5 998250 384801



MARSEILLE



8617

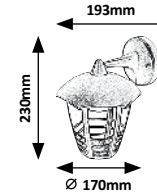

8619

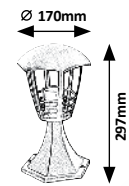

8618

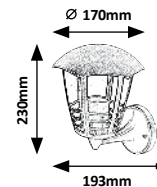

8617 (M) (P)

☒ E27 / 1x max. 60W
IP44
black/transparent



5 998250 386171

8618 (M) (P)

☒ E27 / 1x max. 60W
IP44
black/transparent



5 998250 386188

8619 (M) (P)

☒ E27 / 1x max. 60W
IP44
black/transparent



5 998250 386195

MARSEILLE

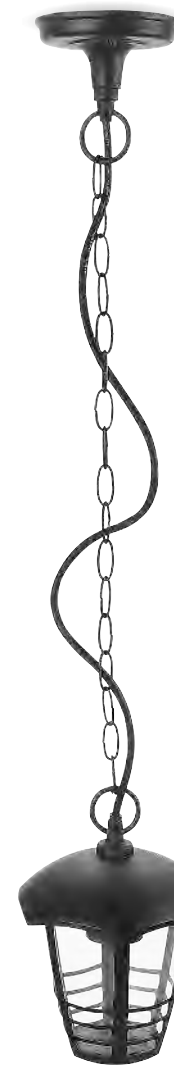

8620

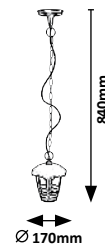

8568

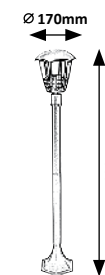

8569

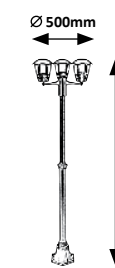

8570

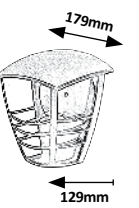

8578

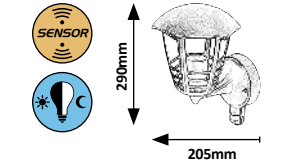

8620 (M) (P)

☒ E27 / 1x max. 60W
IP44
black/transparent



5 998250 386201

8568 (M) (P)

☒ E27 / 1x max. 60W
IP44
black/transparent



5 998250 385686

8569 (M) (P)

☒ E27 / 3x max. 60W
IP44
black/transparent



5 998250 385693

8570 (M) (P)

☒ E27 / 1x max. 60W
IP44
black/transparent



5 998250 385709

8578 (M) (P)

☒ E27 / 1x max. 60W
IP44
☒ 0,5-12m, 140°
black/transparent



5 998250 385785

SORRENTO

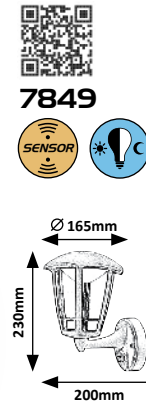

7849

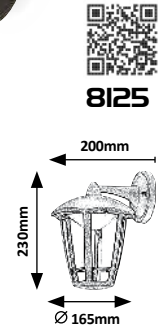

8125



8126



8127

SORRENTO

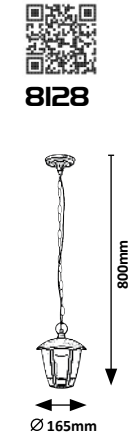

8128

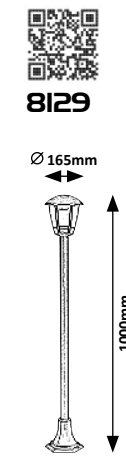

8129

7849 (P)

LED / 8W
(500lm, 3000K) incl.
IP44 • 8m, 120°
matte black/transparent



5 998250 378497

8125 (P)

LED / 8W
(500lm, 3000K) incl.
IP44
matte black/transparent



5 998250 381251

8126 (P)

LED / 8W
(500lm, 3000K) incl.
IP44
matte black/transparent



5 998250 381268

8127 (P)

LED / 8W
(500lm, 3000K) incl.
IP44
matte black/transparent



5 998250 381275

8128 (P)

LED / 8W
(500lm, 3000K) incl.
IP44
matte black/transparent



5 998250 381282

8129 (P)

LED / 8W
(500lm, 3000K) incl.
IP44
matte black/transparent



5 998250 381299





MODESTO

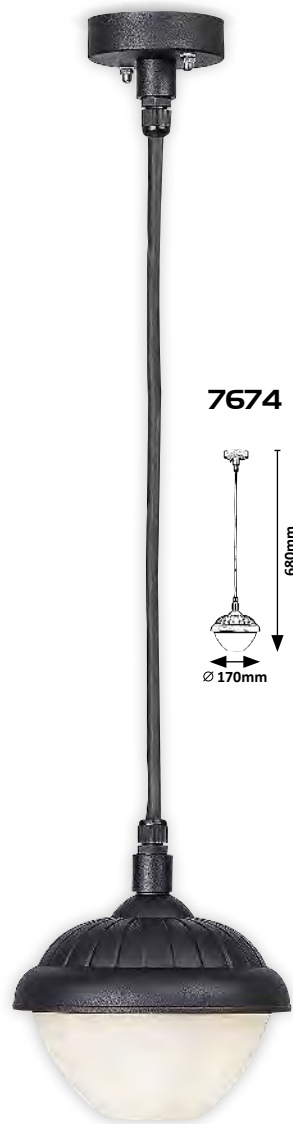

MODESTO



7672 (M) (P)
 ☒ E27 / 1x max. 40W
 IP44
 black/white



7673 (M) (P)
 ☒ E27 / 1x max. 40W
 IP44
 black/white



7674 (M) (P)
 ☒ E27 / 1x max. 40W
 IP44
 black/white



7675 (M) (P)
 ☒ E27 / 1x max. 40W
 IP44
 black/white



7676 (M) (P)
 ☒ E27 / 1x max. 40W
 IP44
 black/white





KONSTANZ

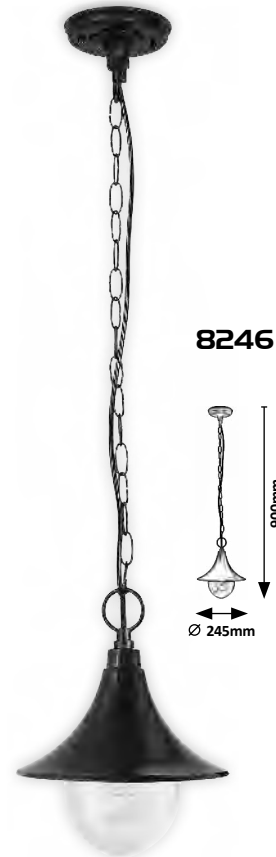
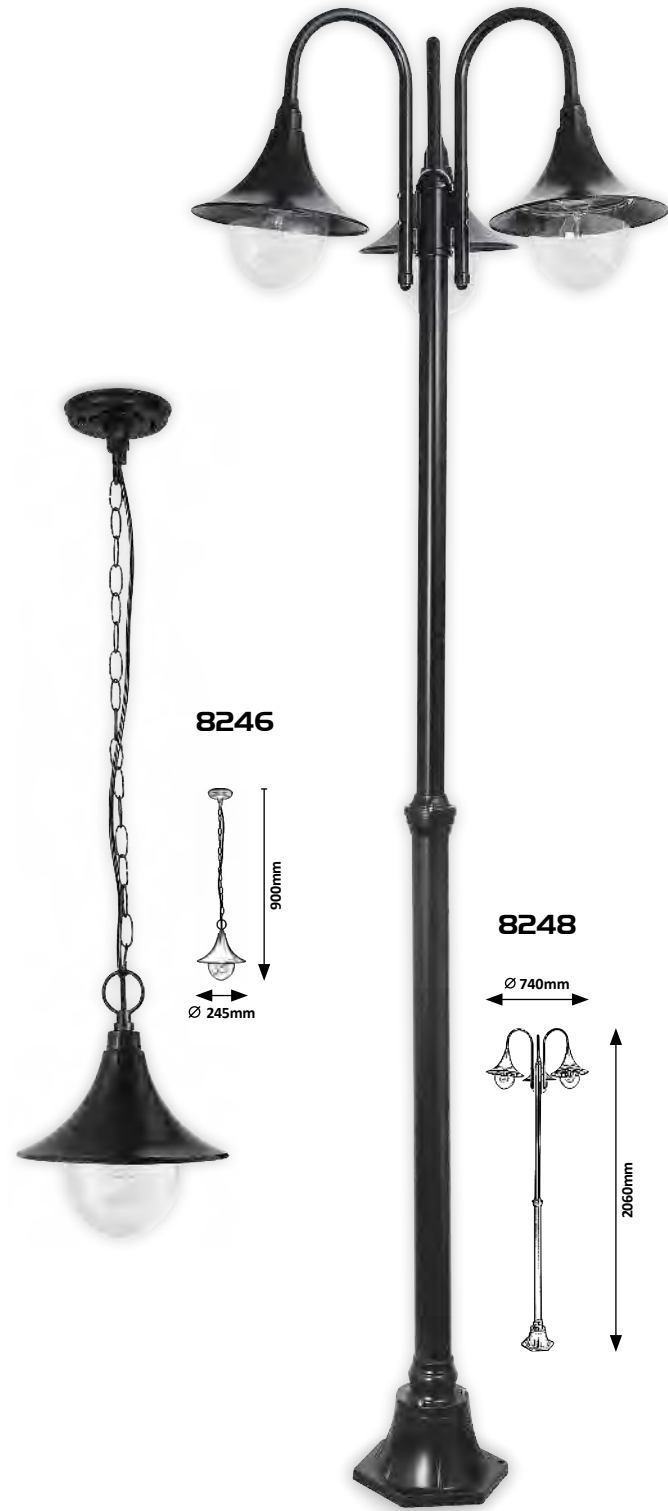

8245 **M P**

☒ E27 / 1x max. 100W
IP44 • 19609
black/transparent



8246 **M P**

☒ E27 / 1x max. 100W
IP44 • 19609
black/transparent



8247 **M P**

☒ E27 / 1x max. 100W
IP44 • 19609
black/transparent



8248 **M P**

☒ E27 / 3x max. 100W
IP44 • 19609
black/transparent



VIGO

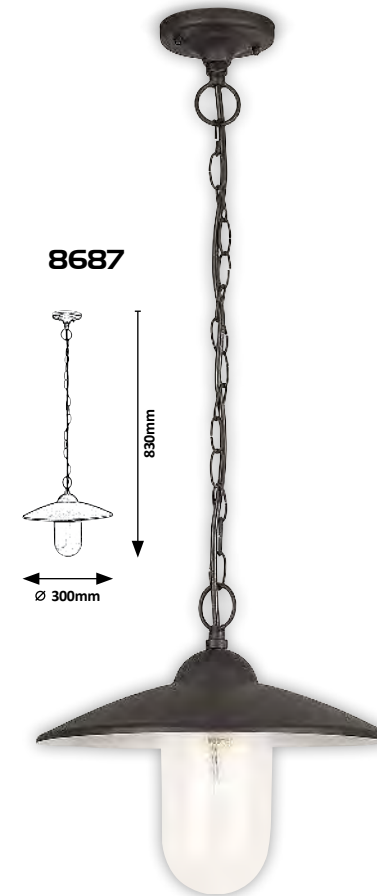

8686 **M G**

☒ E27 / 1x max. 60W
IP44 • 19446
matte black/white/
transparent



8687 **M G**

☒ E27 / 1x max. 60W
IP44 • 19446
matte black/white/
transparent



PAVIA

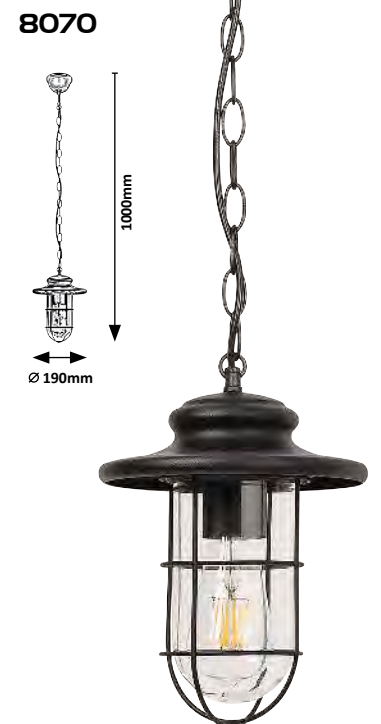

8069 **M G**

☒ E27 / 1x max. 60W
IP44 • 19527
matte black/transparent



8070 **M G**

☒ E27 / 1x max. 60W
IP44 • 19527
matte black/transparent



OSLO



8680

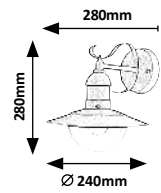

8682

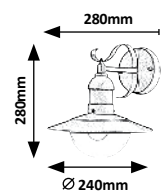

8716

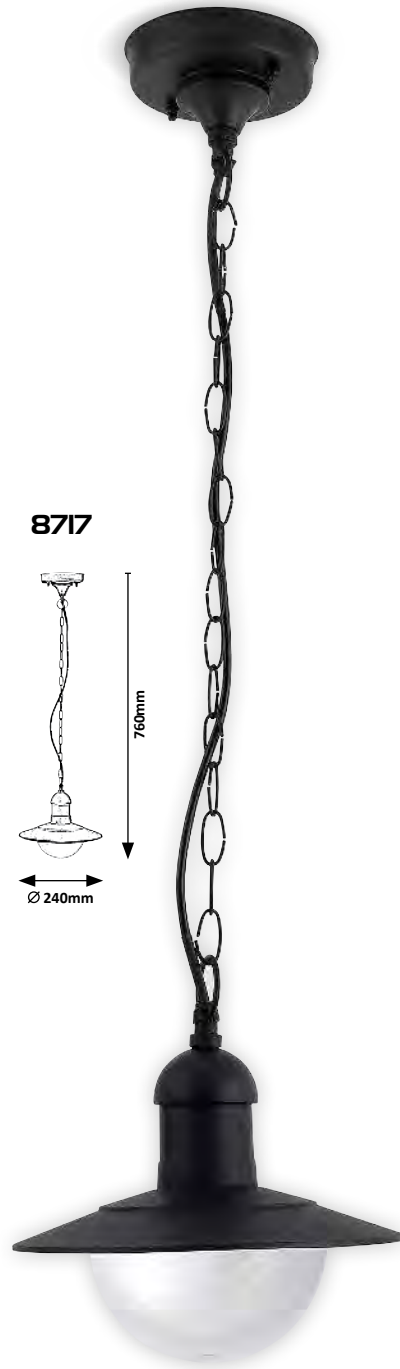
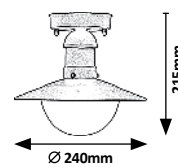

8717

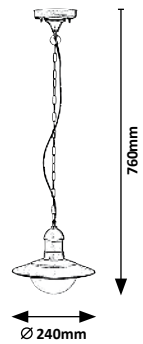

8680 **M P**

☒ E27 / 1x max. 60W
IP44 • 19050
black/transparent



5 998250 386805

8682 **M P**

☒ E27 / 1x max. 60W
IP44 • 19050
green/transparent



5 998250 386829

8716 **M P**

☒ E27 / 1x max. 60W
IP44 • 19050
black/transparent



5 998250 387161

8717 **M P**

☒ E27 / 1x max. 60W
IP44 • 19050
black/transparent



5 998250 387178

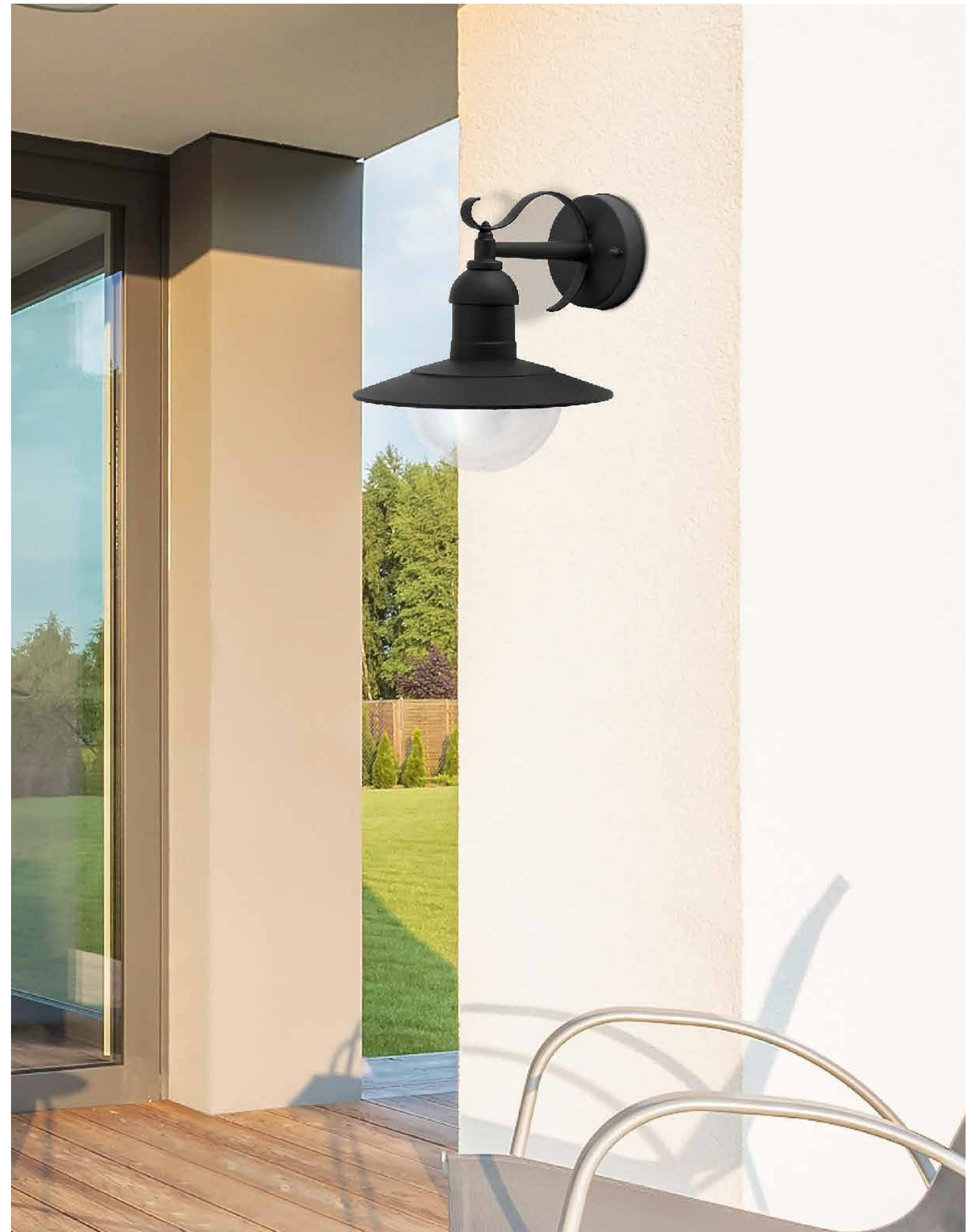



OSLO



8270



8763

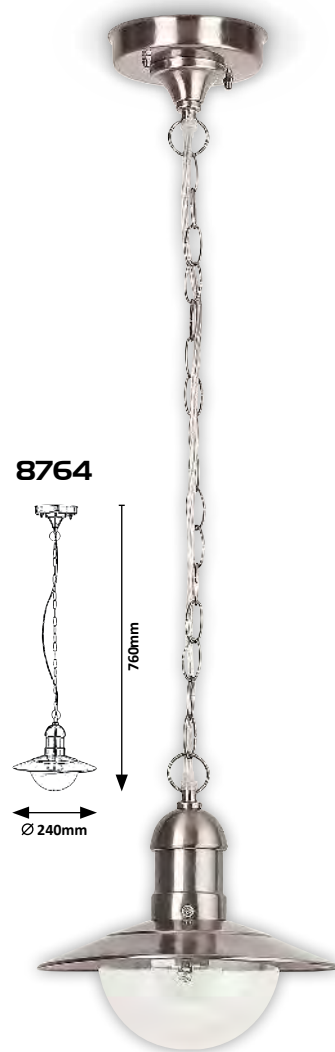

8764

8270 **MP**
 ☒ E27 / 1x max. 60W
 IP44 • 19050
 satin chrome/transparent



8763 **MP**
 ☒ E27 / 1x max. 60W
 IP44 • 19050
 satin chrome/transparent



8764 **MP**
 ☒ E27 / 1x max. 60W
 IP44 • 19050
 satin chrome/transparent



OSLO



8271

8737



8739

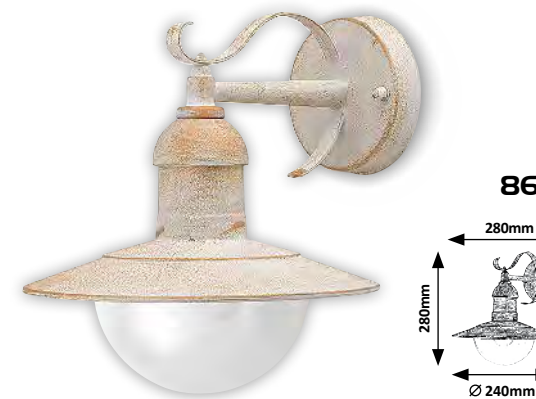

8681



8740

8271 **MP**
 ☒ E27 / 1x max. 60W
 IP44 • 19050
 antique gold/transparent



8681 **MP**
 ☒ E27 / 1x max. 60W
 IP44 • 19050
 antique white/transparent



8736 **MP**
 ☒ E27 / 1x max. 60W
 IP44 • 19050
 antique gold/transparent



8737 **MP**
 ☒ E27 / 1x max. 60W
 IP44 • 19050
 antique gold/transparent



8739 **MP**
 ☒ E27 / 1x max. 60W
 IP44 • 19050
 antique white/transparent



8740 **MP**
 ☒ E27 / 1x max. 60W
 IP44 • 19050
 antique white/transparent



SYDNEY

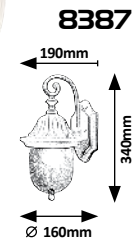

PALERMO

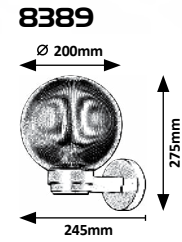

HAGA

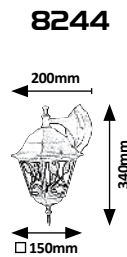
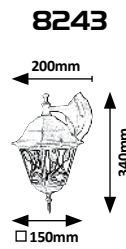

8243 MG

☒ E27 / 1x max. 100W
IP44 • 19187
black/transparent



8244 MG

☒ E27 / 1x max. 100W
IP44 • 19187
antique gold/transparent



8387 MG

☒ E27 / 1x max. 60W
IP23 • 9802
black/transparent



8388 MG

☒ E27 / 1x max. 60W
IP23 • 9802
antique gold/transparent



8389 P

☒ E27 / 1x max. 40W
IP43 • 19055
black/transparent





DARIUS



8190

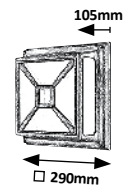

HEKTOR



8496

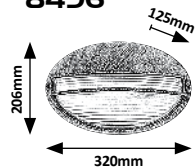

8499

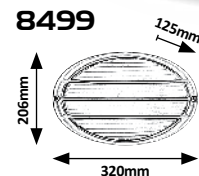

DURANGO



8766

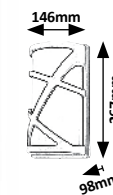

8767

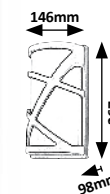

DENVER 4

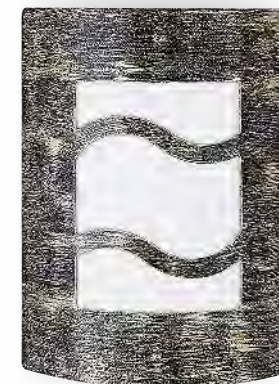

8517



8518

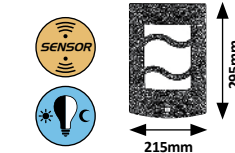

8190 (M) (P)

☒ E27 / 2x max. 60W
IP54
antique gold/white



5 998250 381909

8496 (M) (G)

☒ E27 / 1x max. 100W
IP54 • 9282
antique gold/white



5 998250 384962

8499 (M) (G)

☒ E27 / 1x max. 100W
IP54 • 9282
antique gold/white



5 998250 384993

8766 (M) (P)

☒ E27 / 1x max. 40W
IP54
brown/white



5 998250 387666

8767 (M) (P)

☒ E27 / 1x max. 40W
IP54
anthracite/white



5 998250 387673

8517 (M) (P)

☒ E27 / 1x max. 60W
IP44
antique gold/white



5 998250 385174

8518 (M) (P)

☒ E27 / 1x max. 60W
IP44
8m, 120°
antique gold/white



5 998250 385181

INNSBRUCK



MANHATTAN



BIRMINGHAM

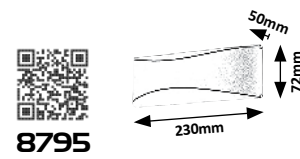

ROMA

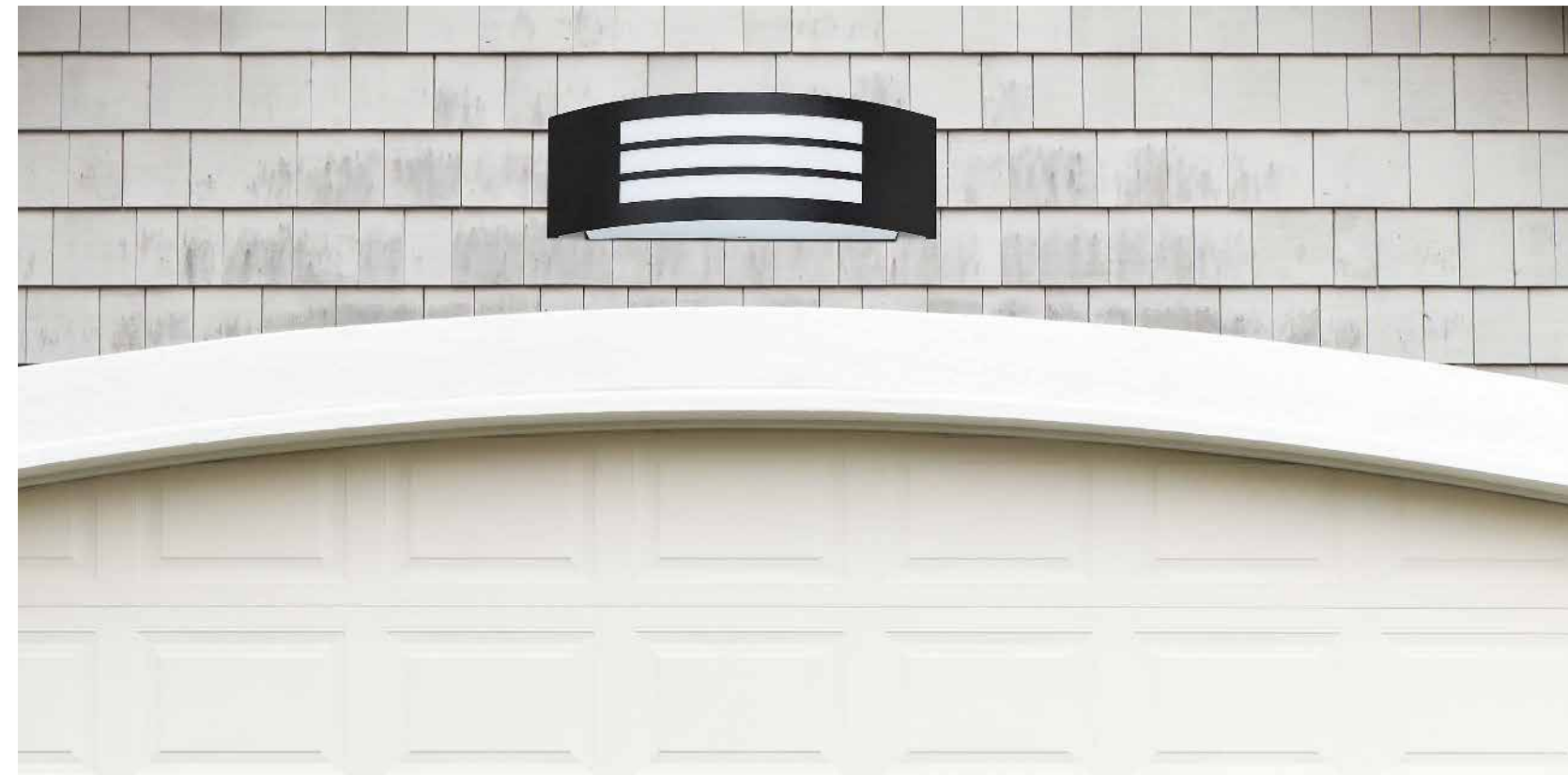
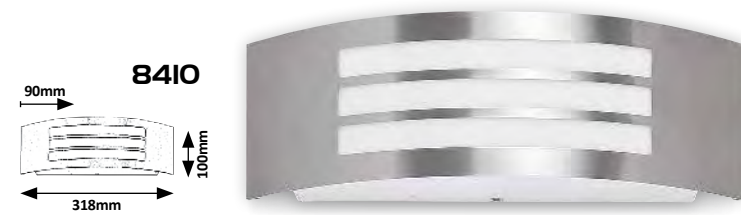

8748 (M) (P)

☒ E27 / 1x max. 14W
IP44
antique gold/white



5 998250 387482

8749 (M) (P)

☒ E27 / 1x max. 14W
IP44
satin chrome/white



5 998250 387499

8359 (M) (P)

☒ E27 / 1x max. 60W
IP54
matte black/white



5 998250 383590

8510 (M) (P)

☒ E27 / 1x max. 60W
IP54
antique gold/white



5 998250 385105

8795 (M) (P)

☑ LED / 10W
(1000lm, 4000K) incl.
IP65
anthracite/white



5 998250 387956

8409 (M) (P)

☒ E27 / 1x max. 14W
IP44
matte black/white



5 998250 384092

8410 (M) (P)

☒ E27 / 1x max. 14W
IP44
satin chrome/white



5 998250 384108

8511 (M) (P)

☒ E27 / 1x max. 14W
IP44
antique gold/white



5 998250 385112

8776 (M) (P)

☒ E27 / 1x max. 14W
IP44
anthracite/white



5 998250 387765

SILISTRA



7891

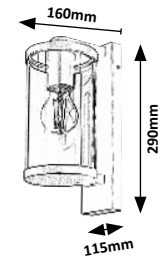

7892

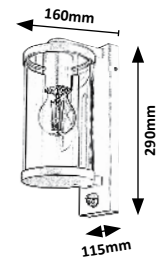

TOPEKA



8140

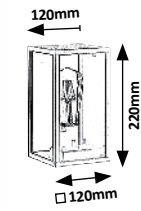

SEVILLA



8799

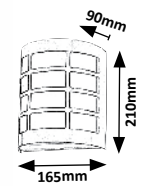

8800

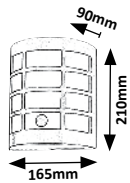

NORVICH



8753

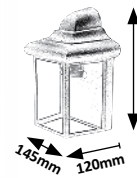

8754

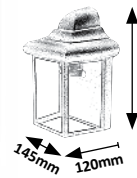

7891 MG

☒ E27 / 1x max. 60W
IP44 • 19852
anthracite/transparent



5 998250 378916

7892 MG

☒ E27 / 1x max. 60W
IP44 • 19852
☒ 1-12m, 110°
anthracite/transparent



5 998250 378923

8799 MP

☒ E27 / 1x max. 11W
IP44
satin chrome/white



5 998250 387994

8800 MP

☒ E27 / 1x max. 11W
IP44 • ☒ 0-5m, 100°
satin chrome/white



5 998250 388007

8140 MG

☒ E27 / 1x max. 60W
IP54 • 19515
transparent/black



5 998250 381404

8753 MG

☒ E27 / 1x max. 60W
IP43
☒ 19524 • ☒ 19523
antique white/transparent



5 998250 387536

8754 MG

☒ E27 / 1x max. 60W
IP43
☒ 19524 • ☒ 19523
antique gold/transparent



5 998250 387543



SEATTLE



RODEZ



GENOVA



ZILAH



ECUADOR



OPOLE



8169 (M) (P)
 ☒ E27 / 1x max. 11W
 IP44
 black/white



8229 (M) (P)
 ☒ E27 / 1x max. 11W
 IP44
 satin chrome/white



8269 (M) (P) (G)
 ☒ E27 / 1x max. 40W
 IP44 • 19129
 satin chrome/white



8940 (M) (P)
 ☒ LED / 12W
 (800lm, 4000K) incl.
 IP44
 anthracite/white



7987 (M) (P)
 ☒ E27 / 1x max. 15W
 IP44 • 19854
 satin chrome/white



7996 (M) (P)
 ☒ LED / 10W
 (800lm, 4000K) incl.
 IP65
 anthracite/white



7997 (M) (P)
 ☒ LED / 11W
 (800lm, 4000K) incl.
 IP54 • 6m, 120°
 anthracite/white



7796 (P)
 ☒ E27 / 1x max. 12W
 IP65
 matte black/white



7797 (P)
 ☒ E27 / 1x max. 12W
 IP65
 matte black/white



VARNA

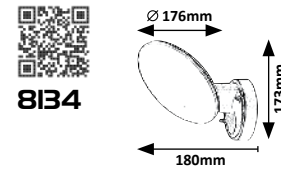

8134

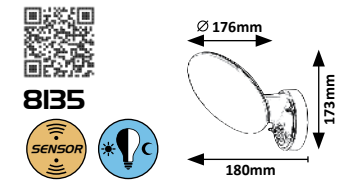

8135

TROGIR

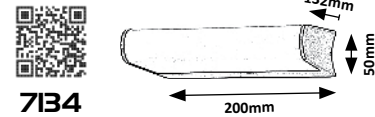
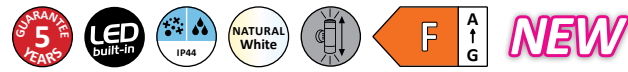

7134

HALDEN

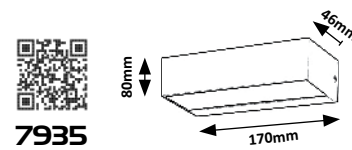
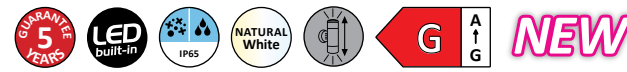

7935

BONA

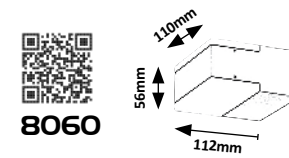

8060

LIMA

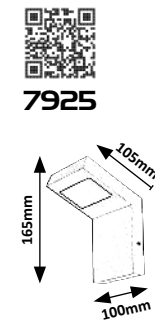

7925

PALANGA

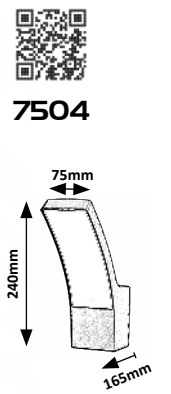

7504

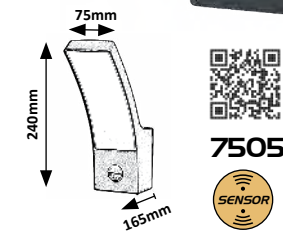

7505

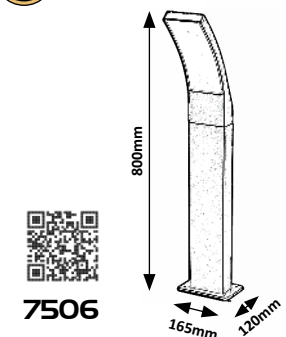

7506

8134 P

LED / 12W
(720lm, 4000K) incl.
IP54
black/white



5 998250 381343

8135 P

LED / 12W
(720lm, 4000K) incl.
IP54 • 8m, 120°
black/white



5 998250 381350

7134 M P

LED / 6,5W
(590lm, 4000K) incl.
IP44
anthracite/white



5 998250 371344

7935 P

LED / 9W
(640lm, 4000K) incl.
IP65
black/white



5 998250 379357

8060 M P

LED / 9W
(678lm, 4000K) incl.
IP54
anthracite/white



5 998250 380605

7925 P

LED / 9W
(600lm, 3000K) incl.
IP44
matte black/white



5 998250 379258

7504 M P

LED / 12W
(800lm, 3000K) incl.
IP44
anthracite/white



5 998250 375045

7505 M P

LED / 12W
(800lm, 3000K) incl.
IP44 • 7m, 106°
anthracite/white



5 998250 375052

7506 M P

LED / 12W
(800lm, 3000K) incl.
IP44
anthracite/white



5 998250 375069

BELFAST

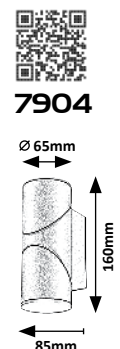

7904

Ø 65mm
160mm
85mm

AKRON



8149

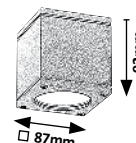

92mm
87mm



8150

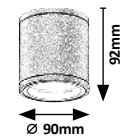

92mm
Ø 90mm

ZOMBOR



7817

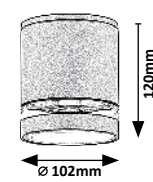

120mm
Ø 102mm



7818

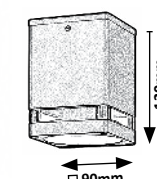

120mm
90mm



7819

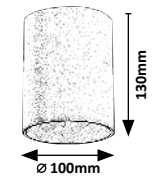

130mm
Ø 100mm



7820

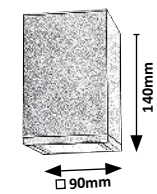

140mm
90mm

ELVA



7929

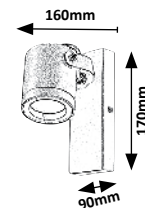

170mm
90mm
160mm



7930

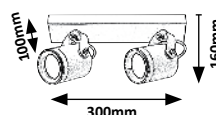

160mm
300mm
100mm

7904 **MP**

LED / 12,9W
(620lm, 3000K) incl.
IP65
anthracite/white



5 998250 379043

7929 **MG**

GU10 / 1x max. 35W
IP44
anthracite/transparent



5 998250 379296

7930 **MG**

GU10 / 2x max. 35W
IP44
anthracite/transparent



5 998250 379302

8149 **MG**

GU10 / 1x max. 35W
IP54
anthracite



5 998250 381497

8150 **MG**

GU10 / 1x max. 35W
IP54
anthracite



5 998250 381503

7817 **MP**

GU10 / 1x max. 35W
IP54
anthracite/transparent



5 998250 378176

7818 **MP**

GU10 / 1x max. 35W
IP54
anthracite/transparent



5 998250 378183

7819 **MG**

GU10 / 1x max. 35W
IP54
anthracite/opal glass



5 998250 378190

7820 **MG**

GU10 / 1x max. 35W
IP54
anthracite/opal glass



5 998250 378206

7904





CARDIFF



8794

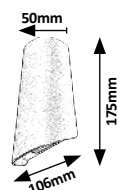

BALTIMORE



8730

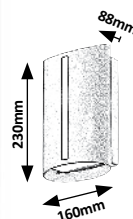

8731

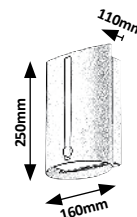

NESNA



7951

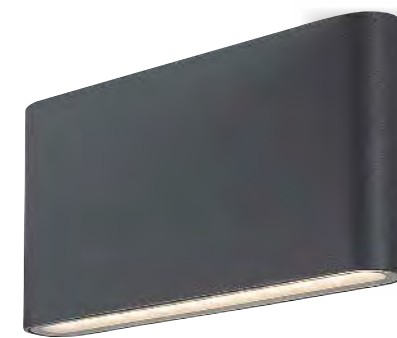
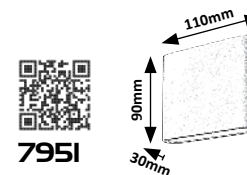

7952

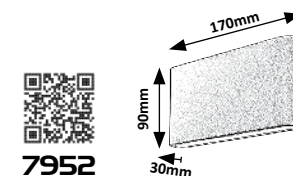

MARIBOR



8873

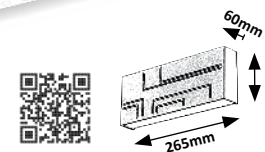

8874



8873



8874



8794 (M) (P)

LED / 11W
(1200lm, 4000K) incl.
IP65
anthracite



5 998250 387949

8730 (M) (P)

E27 / 1x max. 25W
IP54
matte black



5 998250 387307

8731 (M) (P)

E27 / 1x max. 25W
IP44
2-8 m, 90°
matte black



5 998250 387314

7951 (M) (G)

LED / 6W
(386lm, 3000K) incl.
IP54 • 19626
anthracite/opal glass



5 998250 379517

7952 (M) (G)

LED / 12W
(528lm, 3000K) incl.
IP54 • 19630
anthracite/opal glass



5 998250 379524

8873 (M) (P)

LED / 12W
(780lm, 4000K) incl.
IP65
black



5 998250 388731

8874 (M) (P)

LED / 12W
(780lm, 4000K) incl.
IP65
white



5 998250 388748



NAVIA



FOLLINA

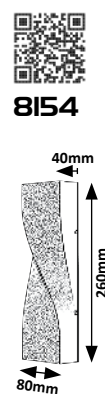

8130 (M)
 LED / 11W
 (641lm, 4000K) incl.
 IP65
 black



5 998250 381305

8154 (M)
 LED / 11W
 (530lm, 4000K) incl.
 IP65
 black



5 998250 381541

LIPPA

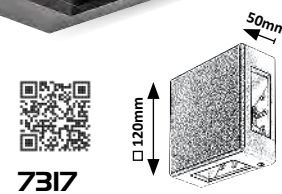

7317



7318

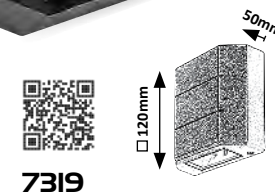

7319



7320

7317 (P)
 LED / 6W
 (190lm, 3000K) incl.
 IP54
 black



5 998250 373171

7318 (P)
 LED / 6W
 (360lm, 3000K) incl.
 IP54
 white



5 998250 373188

7319 (P)
 LED / 6W
 (70lm, 3000K) incl.
 IP54
 black



5 998250 373195

7320 (P)
 LED / 6W
 (150lm, 3000K) incl.
 IP54
 white



5 998250 373201

7317, 7318

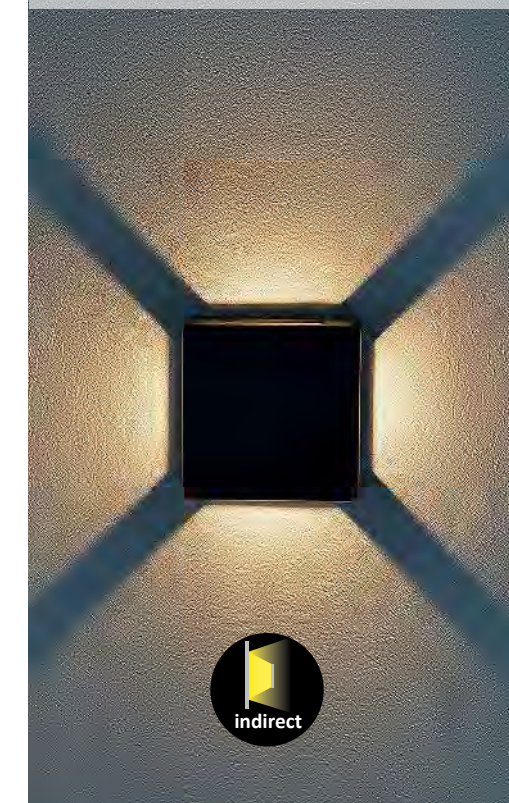

7319, 7320

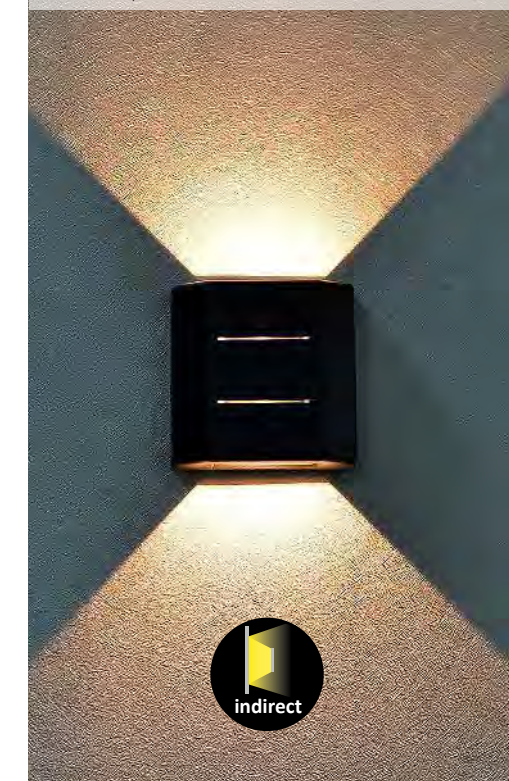

INVERNESS

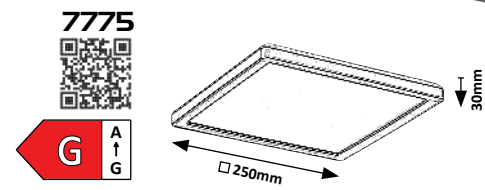
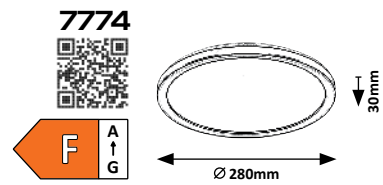

7774 (P)
 LED / 15W
 (1300lm, 2700K-6500K) incl.
 IP44 • 555
 black/white



7775 (P)
 LED / 15W
 (1190lm, 2700K-6500K) incl.
 IP44 • 555
 black/white



7774, 7775

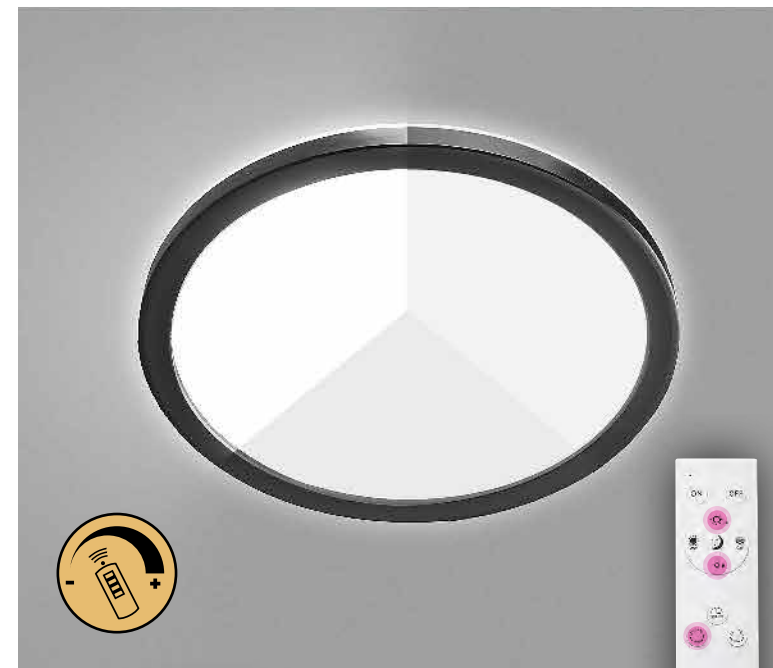
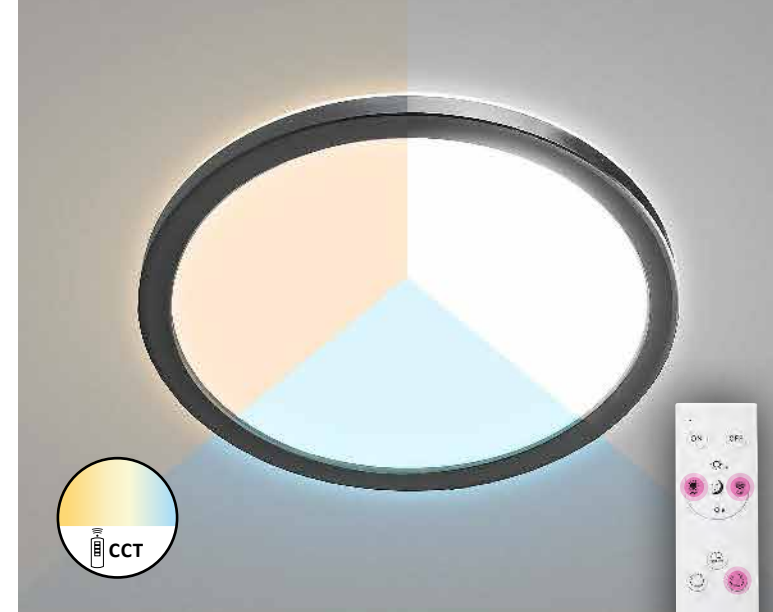

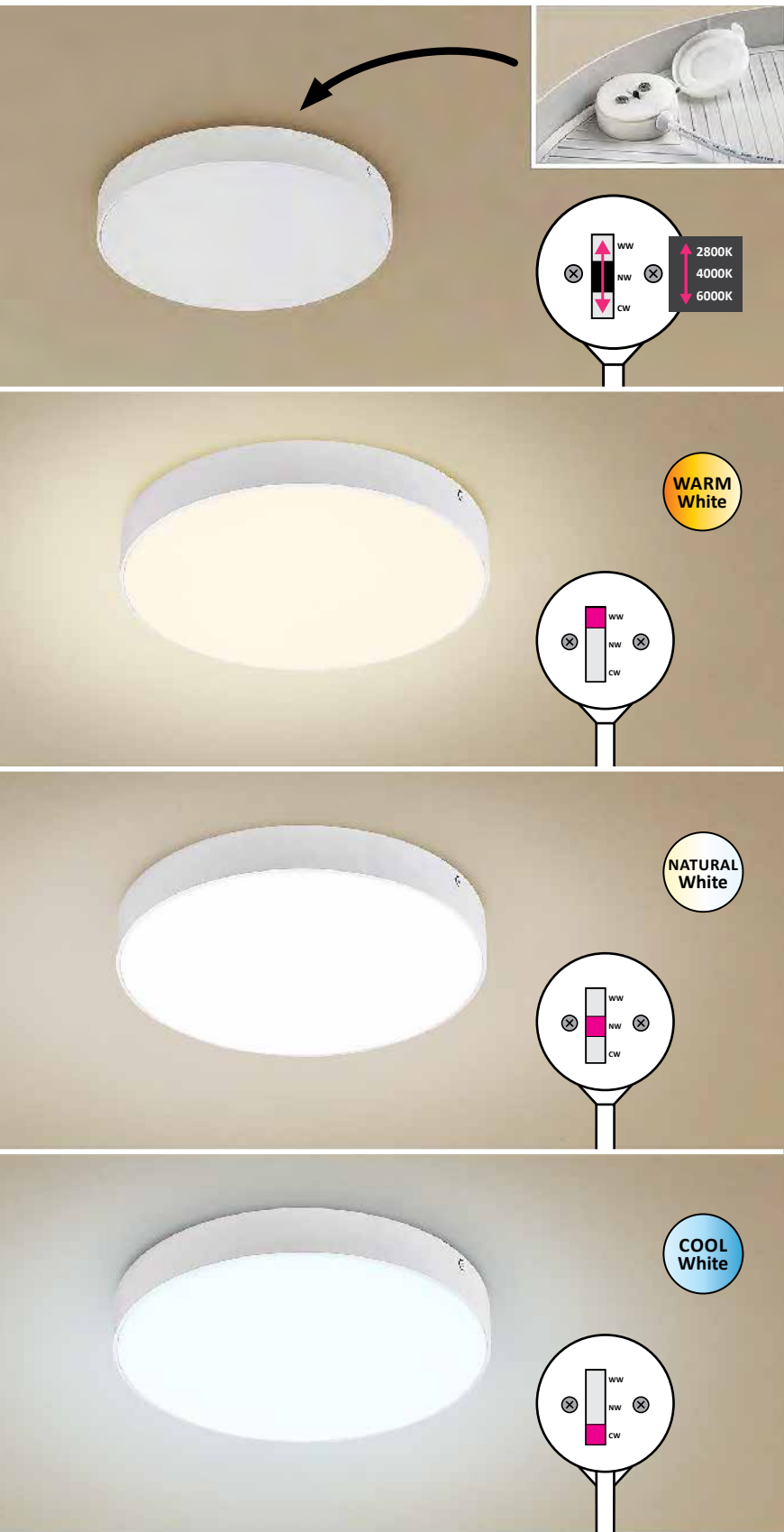

TARTU



TARTU

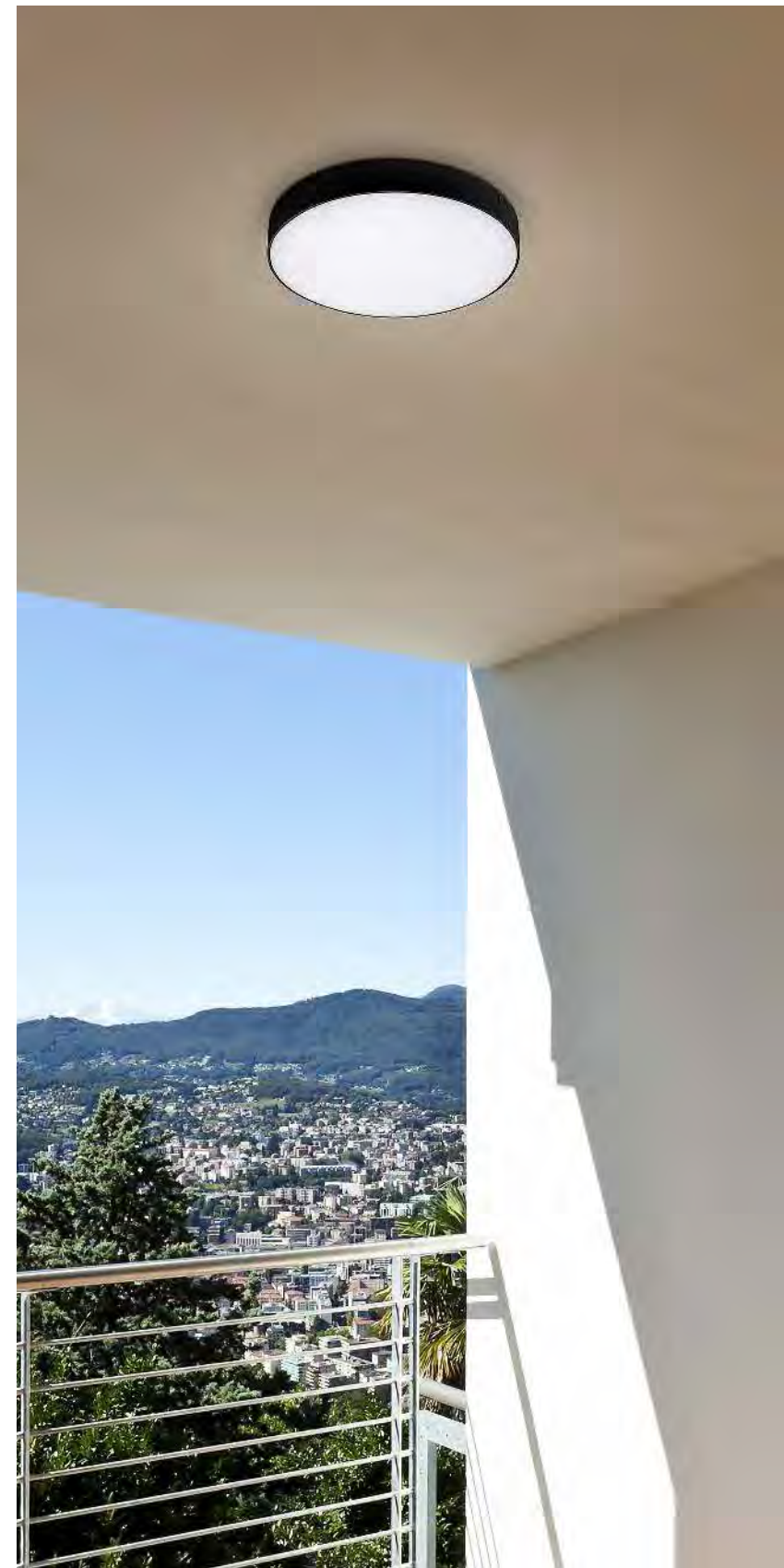

7893 (M) (P)
 LED / 18W
 (1800lm, 2800K, 4000K, 6000K) incl.
 IP44
 matte white/white
 5 998250 378930

7894 (M) (P)
 LED / 24W
 (2500lm, 2800K, 4000K, 6000K) incl.
 IP44
 matte white/white
 5 998250 378947

7895 (M) (P)
 LED / 18W
 (1800lm, 2800K, 4000K, 6000K) incl.
 IP44
 matte white/white
 5 998250 378954

7896 (M) (P)
 LED / 24W
 (2500lm, 2800K, 4000K, 6000K) incl.
 IP44
 matte white/white
 5 998250 378961

7897 (M) (P)
 LED / 18W
 (1800lm, 2800K, 4000K, 6000K) incl.
 IP44
 matte black/white
 5 998250 378978

7898 (M) (P)
 LED / 24W
 (2500lm, 2800K, 4000K, 6000K) incl.
 IP44
 matte black/white
 5 998250 378985

7899 (M) (P)
 LED / 18W
 (1800lm, 2800K, 4000K, 6000K) incl.
 IP44
 matte black/white
 5 998250 378992

7900 (M) (P)
 LED / 24W
 (2500lm, 2800K, 4000K, 6000K) incl.
 IP44
 matte black/white
 5 998250 379005



HAMBURG

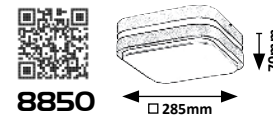
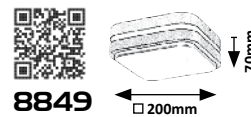
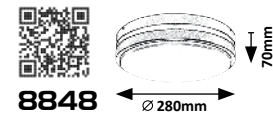
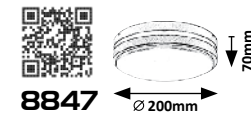

8847 (MP)

LED / 10W
(720lm, 4000K) incl.
IP44
anthracite/white



8848 (MP)

LED / 12W
(900lm, 4000K) incl.
IP44
anthracite/white



8849 (MP)

LED / 10W
(680lm, 4000K) incl.
IP44
anthracite/white



8850 (MP)

LED / 12W
(900lm, 4000K) incl.
IP44
anthracite/white



STUTT GART

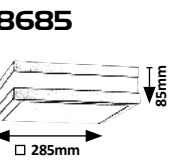
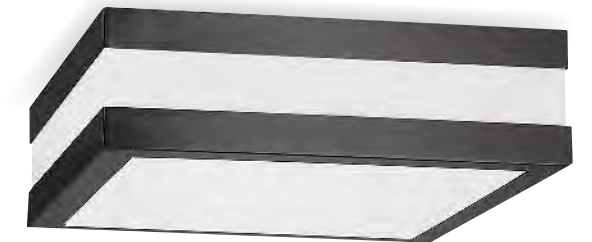
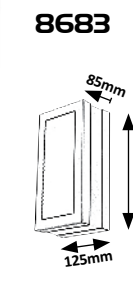
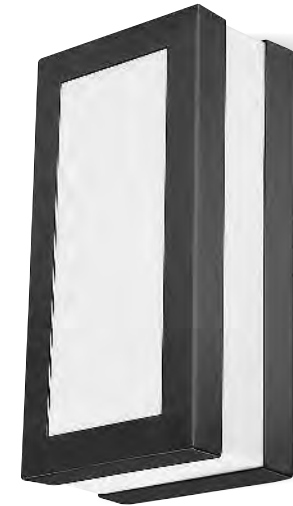
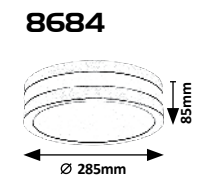
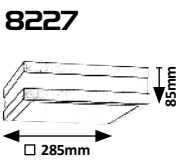
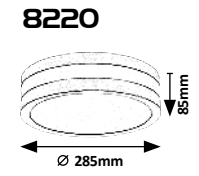
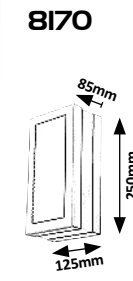

8170 (MP)

E27 / 1x max. 14W
IP44
satin chrome/white



8220 (MP)

E27 / 2x max. 11W
IP44
satin chrome/white



8227 (MP)

E27 / 2x max. 11W
IP44
satin chrome/white



8683 (MP)

E27 / 1x max. 14W
IP44
anthracite/white



8684 (MP)

E27 / 2x max. 11W
IP44
anthracite/white



8685 (MP)

E27 / 2x max. 11W
IP44
anthracite/white





BALIMO

5 YEARS GUARANTEE LED built-in NATURAL White G A ↑ G NEW

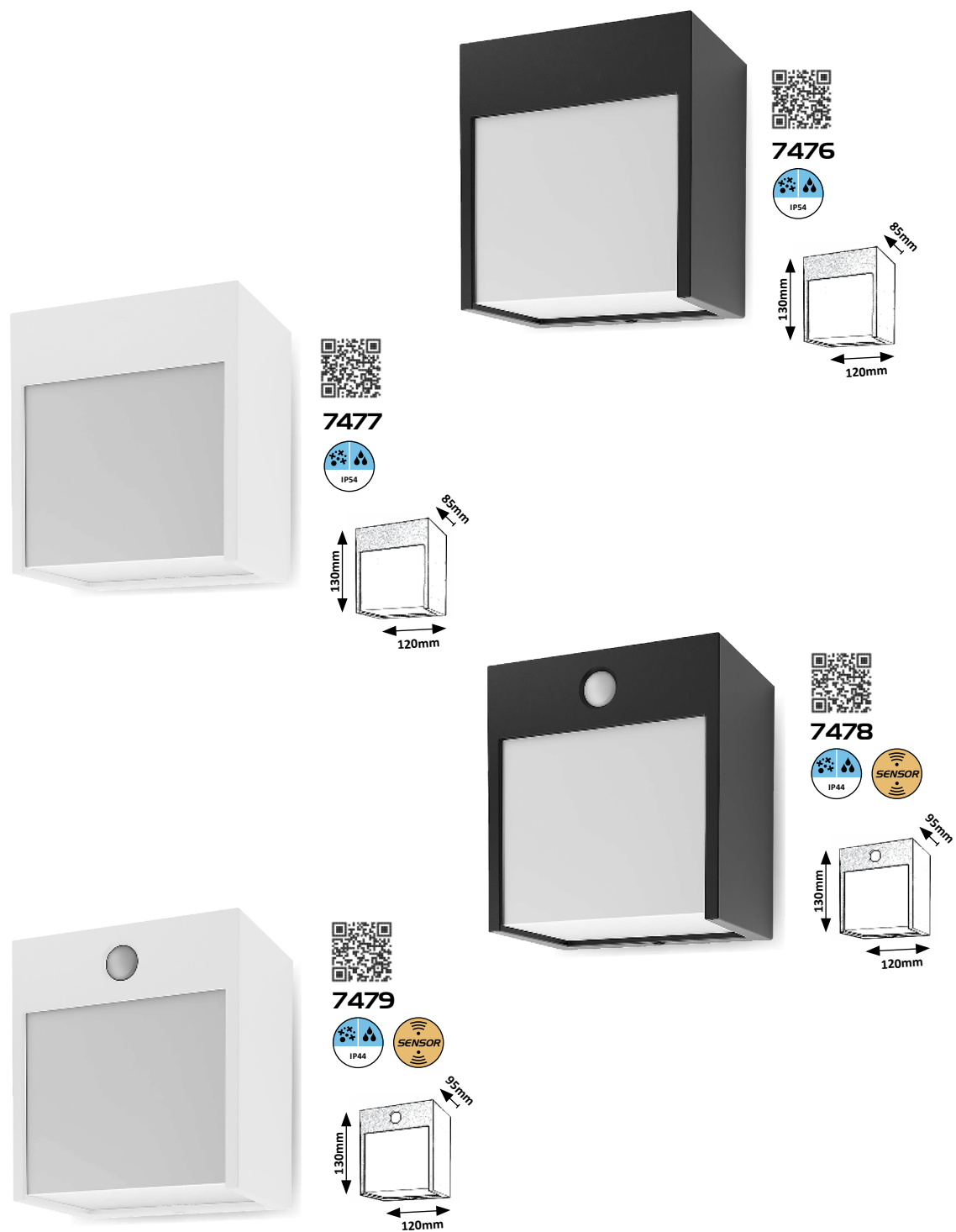

7476 (M P)

LED / 12W
(560lm, 4000K) incl.
IP54
matte black/white



5 998250 374765

7477 (M P)

LED / 12W
(560lm, 4000K) incl.
IP54
matte white/white



5 998250 374772

7478 (M P)

LED / 12W
(560lm, 4000K) incl.
IP44 • 7m, 106°
matte black/white



5 998250 374789

7479 (M P)

LED / 12W
(560lm, 4000K) incl.
IP44 • 7m, 106°
matte white/white



5 998250 374796

MENDOZA

5 YEARS GUARANTEE LED built-in IP65 WARM White G A ↑ G NEW



ONTARIO

5 YEARS GUARANTEE LED built-in IP65 NATURAL White F A ↑ G NEW



7109 (M P)

LED / 6,5W
(550lm, 3000K) incl.
IP65
anthracite/white



5 998250 371092

7110 (M P)

LED / 6,5W
(530lm, 3000K) incl.
IP65
anthracite/white



5 998250 371108

7204 (M P)

LED / 8W
(730lm, 4000K) incl.
IP65
anthracite/white



5 998250 372044



AUSTIN

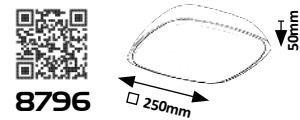

8796

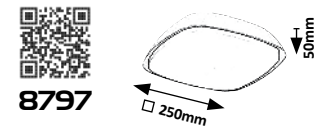

8797

ALVORADA

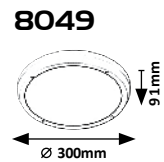

8049

SALVADOR

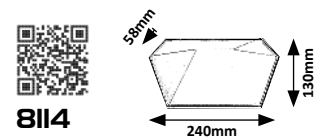

8114

ANDORRA



8829

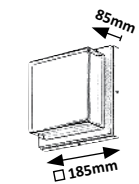

8830

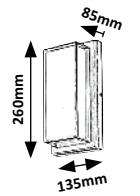

8829 (M) (P)

LED / 12W
(650lm, 4000K) incl.
IP54
black/white



5 998250 388298

8830 (M) (P)

LED / 12W
(680lm, 4000K) incl.
IP54
black/white



5 998250 388304

8796 (M) (P)

LED / 20W
(2000lm, 4000K) incl.
IP65
grey/white



5 998250 387963

8797 (M) (P)

LED / 20W
(2000lm, 4000K) incl.
IP65
anthracite/white



5 998250 387970

8049 (P)

E27 / 2x max. 20W
IP65
anthracite/white



5 998250 380490

8114 (M) (P)

LED / 10W
(543lm, 4000K) incl.
IP65
black/white



5 998250 381145

SOLIN

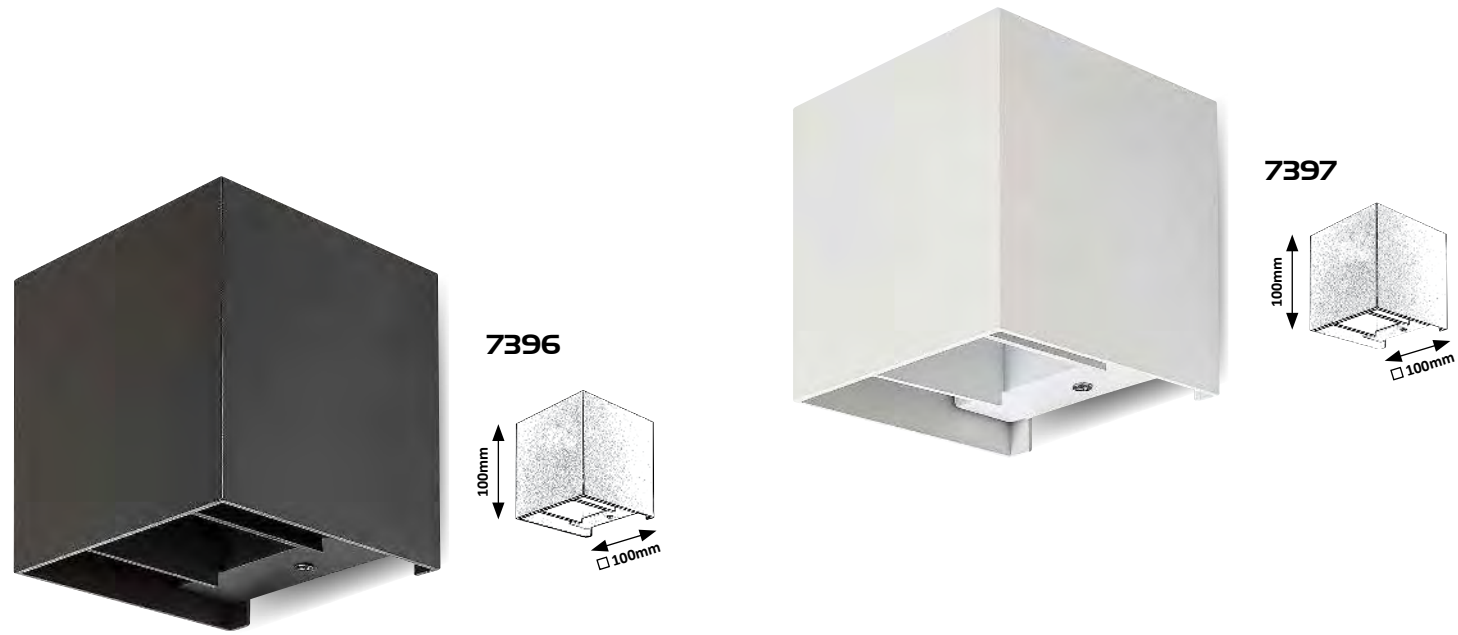

7396, 7397 Adjustable beam angle/Állítható világítási szög/Einstellbarer Abstrahlwinkel



7396 **MP**
 ☒ G9 / 1x max. 42W
 IP54
 matte black



5 998250 373966

7397 **MP**
 ☒ G9 / 1x max. 42W
 IP54
 matte white



5 998250 373973

BUFFALO

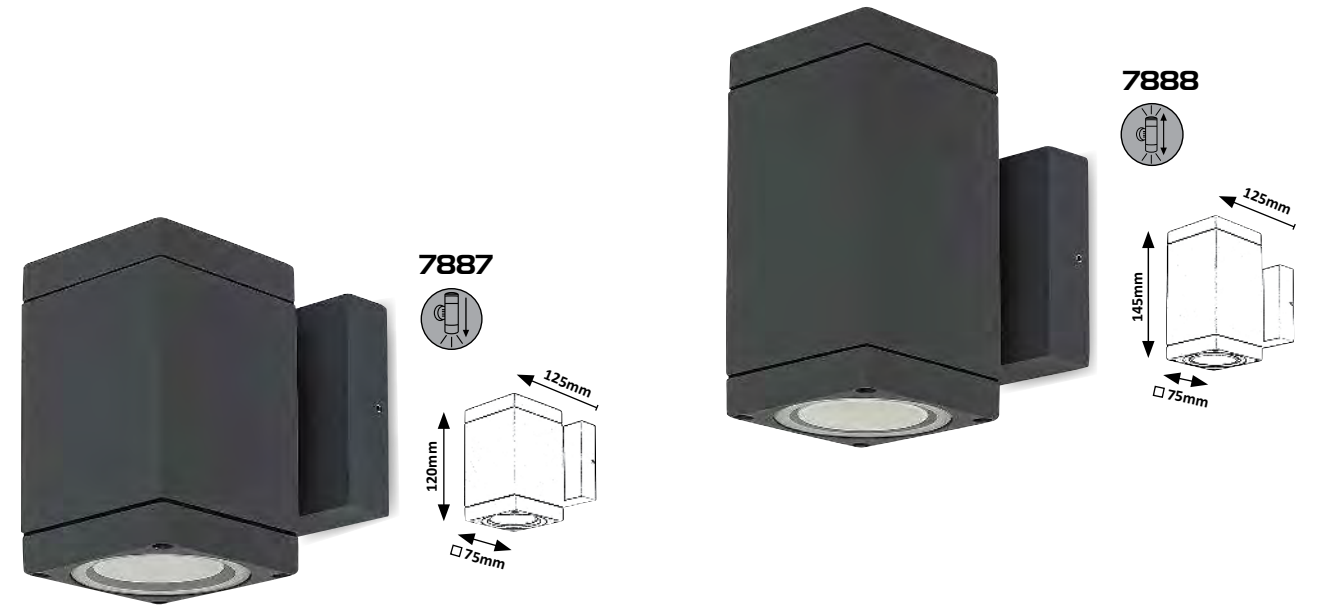

MANDAL



7887 **MG**
 ☒ GU10 / 1x max. 35W
 IP54
 anthracite/transparent



5 998250 378879

7888 **MG**
 ☒ GU10 / 2x max. 35W
 IP54
 anthracite/transparent



5 998250 378886

7959 **MG**
 ☒ GU10 / 1x max. 35W
 IP54
 matte black/transparent



5 998250 379593

7960 **MG**
 ☒ GU10 / 1x max. 35W
 IP54
 matte white/transparent



5 998250 379609



MEDINA



8834

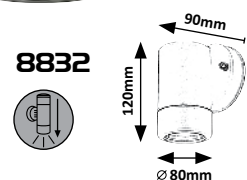

8832



8833



8835

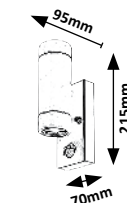

SINTRA



7955

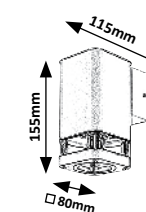

7956

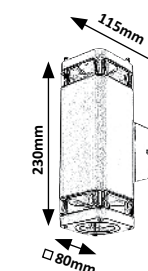

7957

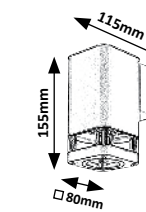

7958

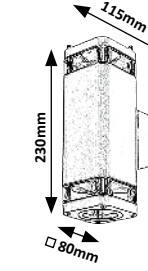

8832 (P)
 ☒ GU10 / 1x max. 10W
 IP44
 matte black



5 998250 388328

8833 (P)
 ☒ GU10 / 2x max. 10W
 IP44
 matte black



5 998250 388335

8834 (P)
 ☒ GU10 / 1x max. 10W
 IP44
 ☒ 2-8m, 90°
 matte black



5 998250 388342

8835 (P)
 ☒ GU10 / 2x max. 10W
 IP44
 ☒ 2-8m, 90°
 matte black



5 998250 388359

7955 (MP)
 ☒ GU10 / 1x max. 25W
 IP44
 matte black/transparent



5 998250 379555

7956 (MP)
 ☒ GU10 / 2x max. 25W
 IP44
 matte black/transparent



5 998250 379562

7957 (MP)
 ☒ GU10 / 1x max. 25W
 IP44
 grey/transparent



5 998250 379579

7958 (MP)
 ☒ GU10 / 2x max. 25W
 IP44
 grey/transparent



5 998250 379586



PHOENIX



8118



8119



8120



8121



8118 MG

☒ GU10 / 1x max. 10W
IP54 • 19625
anthracite



5 998250 381183

8119 MG

☒ GU10 / 2x max. 10W
IP54 • 19625
anthracite



5 998250 381190

8120 MG

☒ GU10 / 1x max. 10W
IP54 • 19625
matte white



5 998250 381206

8121 MG

☒ GU10 / 2x max. 10W
IP54 • 19625
matte white



5 998250 381213

CATANIA



8936



8938



8937



8939



8936 MP

☒ LED / 4W
(350lm, 4000K) incl.
IP44
satin chrome



5 998250 389363

8937 MP

☒ LED / 4W
(350lm, 3000K) incl.
IP44
bronze



5 998250 389370

8938 MP

☒ LED / 8W
(700lm, 4000K) incl.
IP44
satin chrome



5 998250 389387

8939 MP

☒ LED / 8W
(700lm, 3000K) incl.
IP44
bronze



5 998250 389394

7938 MG

☒ GU10 / 1x max. 12W
IP44
satin chrome



5 998250 379388

7939 MG

☒ GU10 / 2x max. 12W
IP44
satin chrome



5 998250 379395

ZAGREB



7938



7939





CHILE

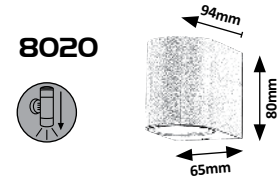

8020

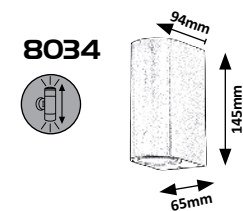

8034

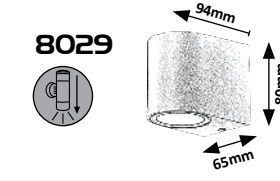

8029

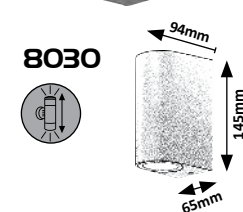

8030

CHILE

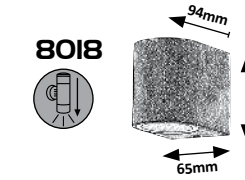

8018

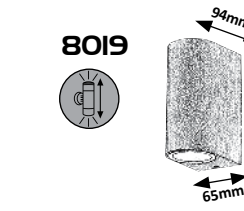

8019

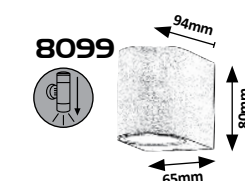

8099

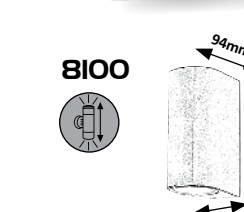

8100



8020 MG

☒ GU10 / 1x max. 35W
IP44
brushed aluminium



5 998250 380209

8029 MG

☒ GU10 / 1x max. 35W
IP44
black



5 998250 380292

8030 MG

☒ GU10 / 2x max. 35W
IP44
black



5 998250 380308

8034 MG

☒ GU10 / 2x max. 35W
IP44
brushed aluminium



5 998250 380346

8018 MG

☒ GU10 / 1x max. 35W
IP44
antique brown



5 998250 380186

8019 MG

☒ GU10 / 2x max. 35W
IP44
antique brown



5 998250 380193

8099 MG

☒ GU10 / 1x max. 35W
IP44
copper



5 998250 380995

8100 MG

☒ GU10 / 2x max. 35W
IP44
copper



5 998250 381008



AMALFI

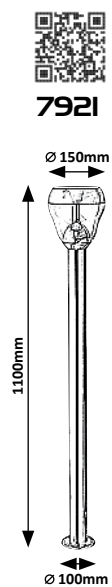

WARSAW

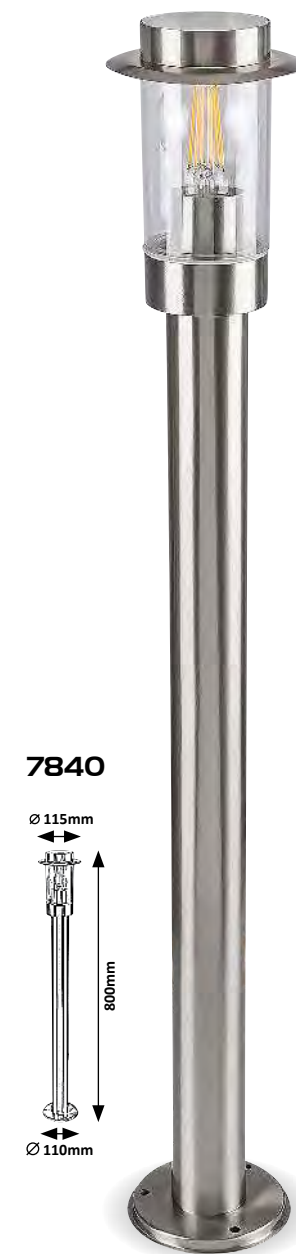
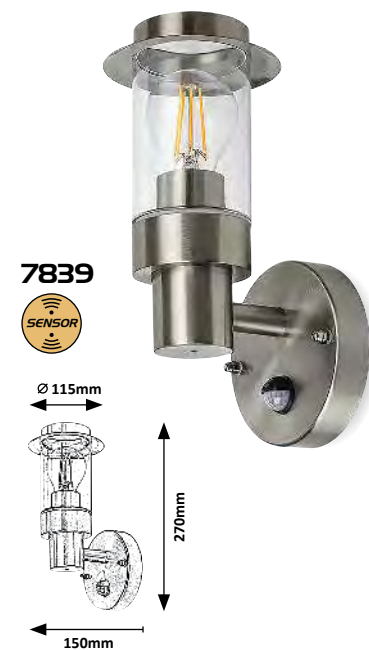

7919 (M) (P)

LED / 8W
(760lm, 4000K) incl.
IP44

satin chrome/transparent



5 998250 379197

7920 (M) (P)

LED / 8,5W
(760lm, 4000K) incl.
IP44 • 1-8m, 90°

satin chrome/transparent



5 998250 379203

7921 (M) (P)

LED / 8W
(760lm, 4000K) incl.
IP44

satin chrome/transparent



5 998250 379210

7838 (M) (P)

E27 / 1x max. 20W
IP44
satin chrome/transparent



5 998250 378381

7839 (M) (P)

E27 / 1x max. 20W
IP44 • 1-12m, 110°

satin chrome/transparent



5 998250 378398

7840 (M) (P)

E27 / 1x max. 20W
IP44

satin chrome/transparent



5 998250 378404

LISBON



7826

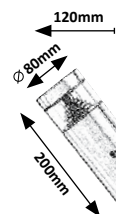

7827

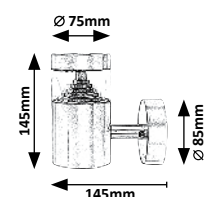

7828

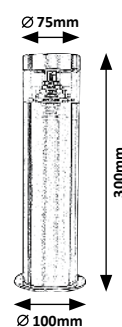

7829

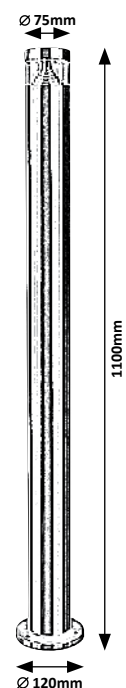

7826 (M) (P)

LED / 7W
(560lm, 4000K) incl.
IP54
satin chrome/transparent



5 998250 378268

7827 (M) (P)

LED / 7W
(560lm, 4000K) incl.
IP54
satin chrome/transparent



5 998250 378275

7828 (M) (P)

LED / 7W
(560lm, 4000K) incl.
IP54
satin chrome/transparent



5 998250 378282

7829 (M) (P)

LED / 7W
(560lm, 4000K) incl.
IP54
satin chrome/transparent



5 998250 378299





DETROIT



ATLANTA



8141 (M) (P)
 LED / 6W
 (450lm, 4000K) incl.
 IP44
 satin chrome/transparent
 5 998250 381411

8142 (M) (P)
 LED / 6W
 (450lm, 4000K) incl.
 IP44
 satin chrome/transparent
 5 998250 381428

8143 (M) (P)
 LED / 6W
 (450lm, 4000K) incl.
 IP44
 satin chrome/transparent
 5 998250 381435

8144 (M) (P)
 LED / 6W
 (450lm, 4000K) incl.
 IP44
 satin chrome/transparent
 5 998250 381442

8166 (M) (P)
 E27 / 1x max. 60W
 IP44
 satin chrome
 5 998250 381664

8167 (M) (P)
 E27 / 2x max. 60W
 IP44
 satin chrome
 5 998250 381671

8168 (M) (P)
 E27 / 1x max. 60W
 IP44
 satin chrome
 5 998250 381688



INOX TORCH



INOX TORCH

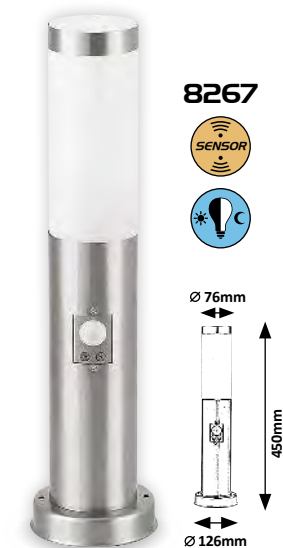

8261 (M) (P)

☒ E27 / 1x max. 25W
 IP44 • 9437
 satin chrome/white



8262 (M) (P)

☒ E27 / 1x max. 25W
 IP44 • 9437
 satin chrome/white



8263 (M) (P)

☒ E27 / 1x max. 25W
 IP44 • 9437
 satin chrome/white



8264 (M) (P)

☒ E27 / 1x max. 25W
 IP44 • 9437
 satin chrome/white



8265 (M) (P)

☒ E27 / 1x max. 25W
 IP44 • 9437
 satin chrome/white



8266 (M) (P)

☒ E27 / 1x max. 25W
 IP44 • 9437
 ☒ 0-5m, 100°
 satin chrome/white



8267 (M) (P)

☒ E27 / 1x max. 25W
 IP44 • 9437
 ☒ 0-5m, 100°
 satin chrome/white



8268 (M) (P)

☒ E27 / 1x max. 25W
 IP44 • 9437
 ☒ 0-5m, 100°
 satin chrome/white





KATOWICE

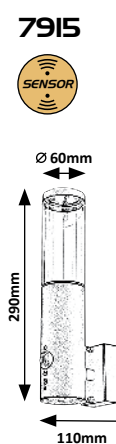
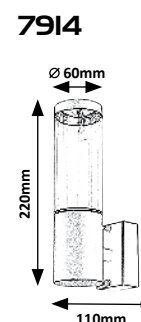

7916

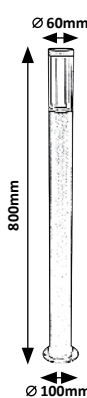

BLACK TORCH

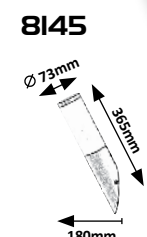

8146

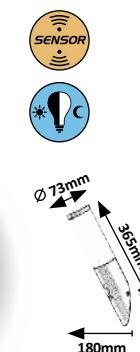

8147

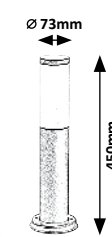

8148

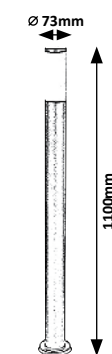

7914 (M) (P)

☒ GU10 / 1x max. 7W
IP44 • 19849
anthracite/transparent



5 998250 379142

7915 (M) (P)

☒ GU10 / 1x max. 7W
IP44 • 19849
☑ 1-8m, 90°
anthracite/transparent

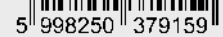

5 998250 379159

7916 (M) (P)

☒ GU10 / 1x max. 7W
IP44 • 19849
anthracite/transparent



5 998250 379166

8145 (M) (P)

☒ E27 / 1x max. 25W
IP44 • 19607
matte black/white



5 998250 381459

8146 (M) (P)

☒ E27 / 1x max. 25W
IP44 • 19607
☑ 0-5m, 100°
matte black/white



5 998250 381466

8147 (M) (P)

☒ E27 / 1x max. 25W
IP44 • 19607
matte black/white



5 998250 381473

8148 (M) (P)

☒ E27 / 1x max. 25W
IP44 • 19607
matte black/white



5 998250 381480



WELLINGTON

 **NEW**



7502

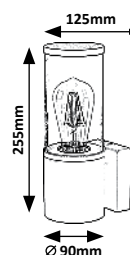

7503

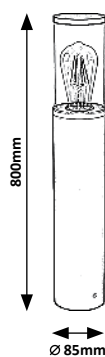

7502 **M P**

☒ E27 / 1x max. 60W
IP44 • 19978
matte black/transparent



7503 **M P**

☒ E27 / 1x max. 60W
IP44 • 19978
matte black/transparent



MIZIL

 **NEW**



7494

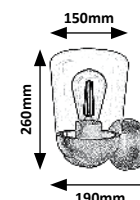

 **2in1 NEW**



3309

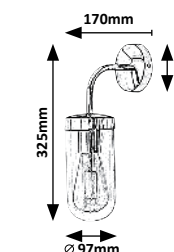

YAGO



3310

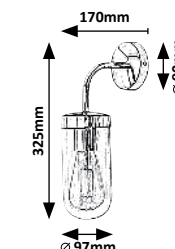

2in1

Bathroom/Outdoor lamp • Földszobai/Kültéri lámpa • Badleuchten/Aussenleuchten



7494 **M G**

☒ E27 / 1x max. 60W
IP54 • 19980
matte black/transparent



3309 **M G**

☒ E27 / 1x max. 60W
IP44 • 19984
chrome/transparent



3310 **M G**

☒ E27 / 1x max. 60W
IP44 • 19984
matte black/transparent





BONN



8337

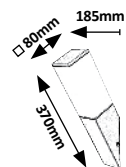

8338

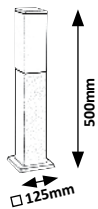

8339

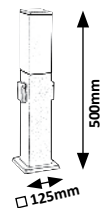

ZADAR



7988

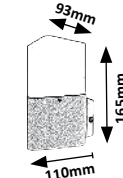

7989

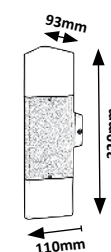

7990

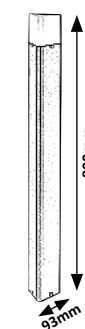

8337 (M) (P)

☒ E27 / 1x max. 60W
IP44 • 19130
matte black/white



5 998250 383378

8338 (M) (P)

☒ E27 / 1x max. 60W
IP44 • 19130
matte black/white



5 998250 383385

8339 (M) (P)

☒ E27 / 1x max. 60W
IP44 • 19130
matte black/white



5 998250 383392

7988 (M) (P)

☒ E27 / 1x max. 15W
IP44
black/white



5 998250 379883

7989 (M) (P)

☒ E27 / 2x max. 15W
IP44
black/white



5 998250 379890

7990 (M) (P)

☒ E27 / 1x max. 15W
IP44
black/white



5 998250 379906

AMARILLO



TRENTO

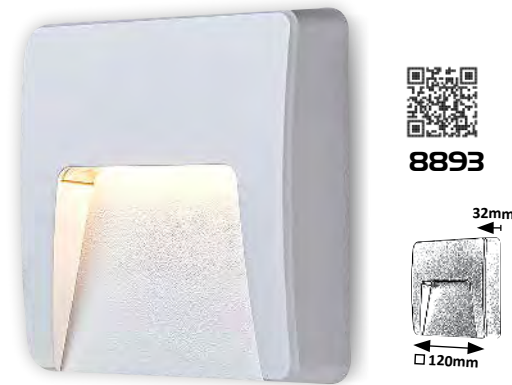

PUEBLO

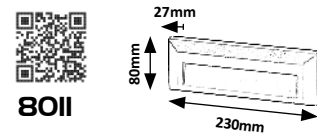
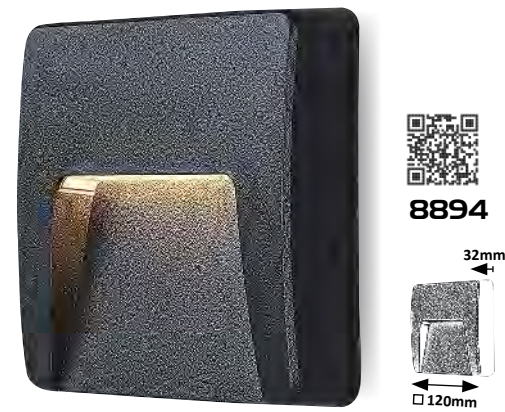
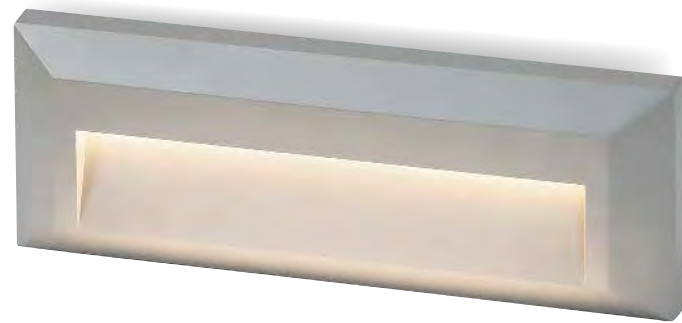

7969

(P)

• LED / 1,5W (50lm, 3000K) incl.
DC 4,5V 3xAAA excl.
IP44 • 2-8m, 90°
black



5 998250 379692

7980

(P)

• LED / 1,5W (50lm, 3000K) incl.
DC 4,5V 3xAAA excl.
IP44 • 2-8m, 90°
white



5 998250 379807

8011

(P)

• LED / 1,6W
(103lm, 4000K) incl.
IP65
grey



5 998250 380117

8893

(P)

• LED / 3W
(100lm, 4000K) incl.
IP65
white



5 998250 388939

8894

(P)

• LED / 3W
(100lm, 4000K) incl.
IP65
anthracite



5 998250 388946





MORA

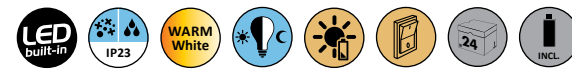

8948

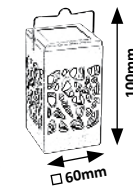

8949

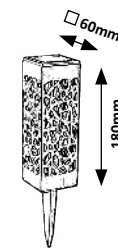

SOLAR 1



8365

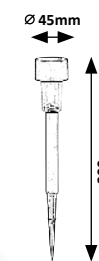

8366

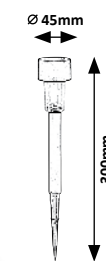

KROBIA



7814

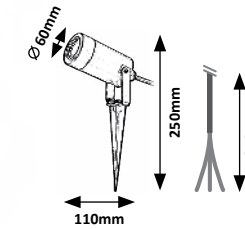

FUNGHETTO



7877

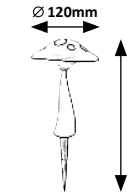

YOLA



7850



8948 P

LED / 0,07W
(1lm, 3000K) incl.
DC 1,2V incl. • •
IP23 • black



8949 P

LED / 0,16W
(2lm, 3000K) incl.
DC 1,2V incl. • •
IP23 • black



8365 P

LED / 0,1W incl.
DC 1,2V incl.
IP44
black



8366 M P

LED / 0,1W incl.
DC 1,2V incl.
IP44
satin chrome



7814 P

GU10 / 1x max. 4W
IP65
black/transparent



7850 M G

RGB LED / 0,06W
DC 1,2V incl.
IP44 • •
satin chrome/transparent



7877 P

LED / 0,06W
(3000K) incl.
DC 1,2V • •
IP44 • red/white





DANNET

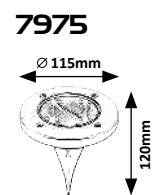

BILBAO



TACOMA

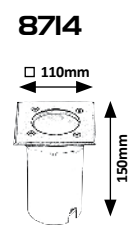

OSTRAVA



7880

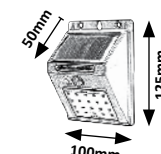

7881

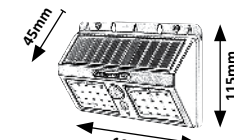

OPAVA



7970

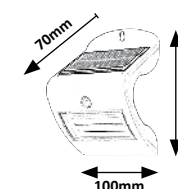

7975 (M) (P)

LED / 0,24W (4lm, 4000K)
DC 1,2V incl. • IP44
satin chrome/ black



5 998250 379753

8104 (P)

LED / 0,2W (4000K) incl.
DC 3,2V incl.
IP67
black



5 998250 381046

8714 (M) (G)

GU10 / 1x max. 50W
IP65
satin chrome



5 998250 387147

7880 (P)

LED / 1,3W (100lm, 4000K) incl.
DC 3,7V incl. • 1x18650 incl.
IP44 • 0-3m, 120°
black



5 998250 378800

7881 (P)

LED / 2,4W (225lm, 4000K) incl.
DC 3,7V incl. • 2x18650 incl.
IP44 • 0-3m, 120°
black



5 998250 378817

7970 (P)

LED / 2W (115lm, 4000K) incl.
DC 3,7V incl. • 1x18650 incl.
IP44 • 2-8m, 90°
white



5 998250 379708



ERIC

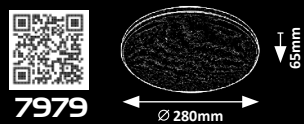
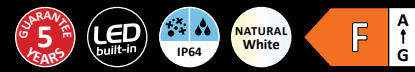

7979 (P)
 LED / 24W
 (2160lm, 4000K) incl.
 IP64
 white



LUCAS



OTHERS / BEST MATCH 396-398.

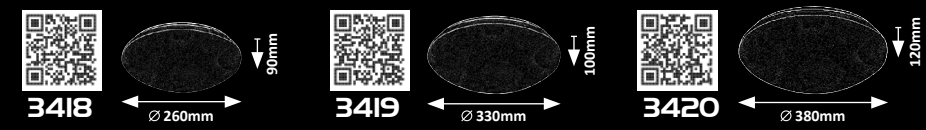
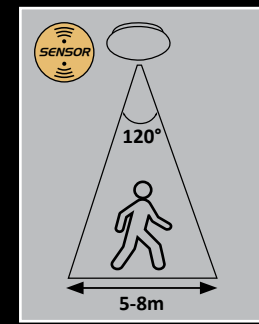

3418 (M P)
 LED / 12W
 (780lm, 4000K) incl.
 IP44 • 19714
 5-8m, 120° • white



3419 (M P)
 LED / 18W
 (1170lm, 4000K) incl.
 IP44 • 19715
 5-8m, 120° • white



3420 (M P)
 LED / 24W
 (1560lm, 4000K) incl.
 IP44 • 19716
 5-8m, 120° • white

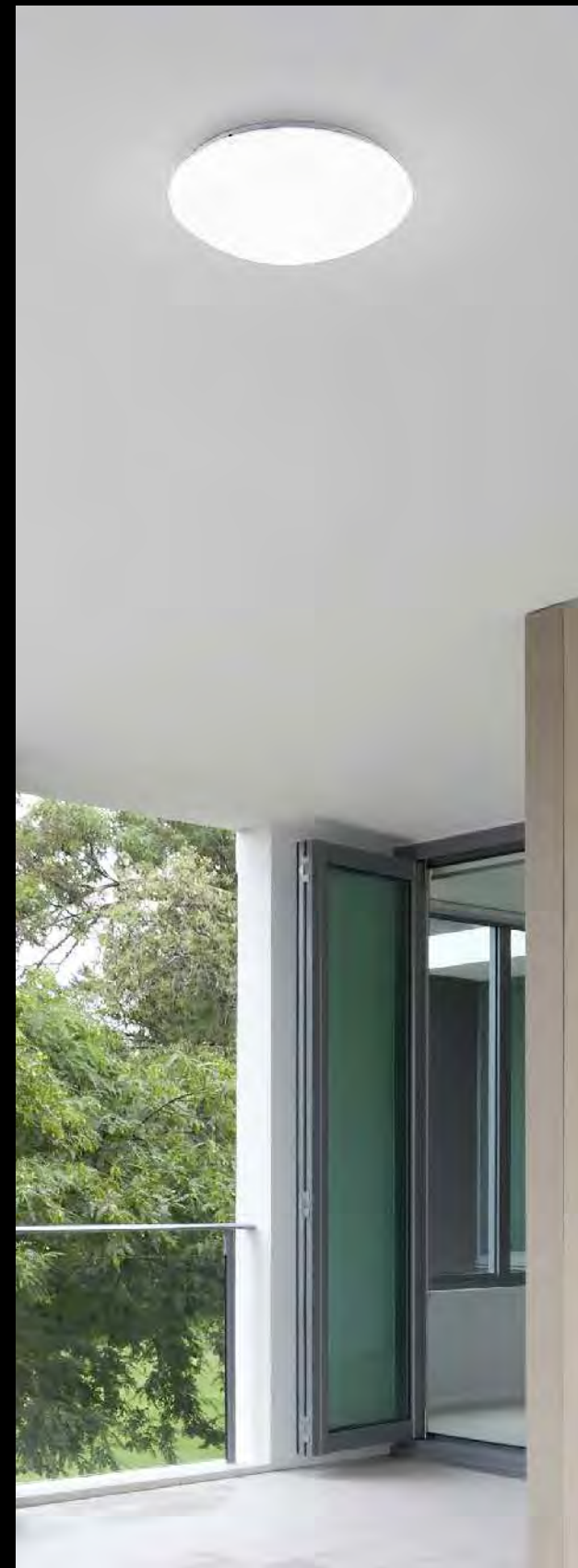



LENTIL



5810

Ø 270mm

LOKI

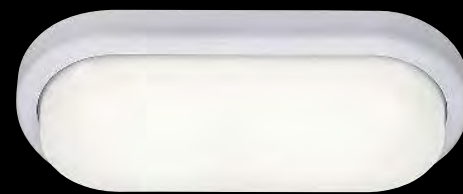

2496

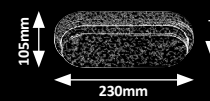

2497

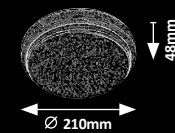

Ø 210mm

2496 (P)

LED / 15W
(1100lm, 4000K) incl.
IP54
white



5 998250 324968

2497 (P)

LED / 15W
(1100lm, 4000K) incl.
IP54
white



5 998250 324975

5810 (P)

E27 / 1x max. 60W
IP54
white



5 998250 358109

DROP LIGHT



I454

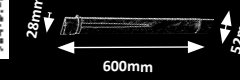

I455

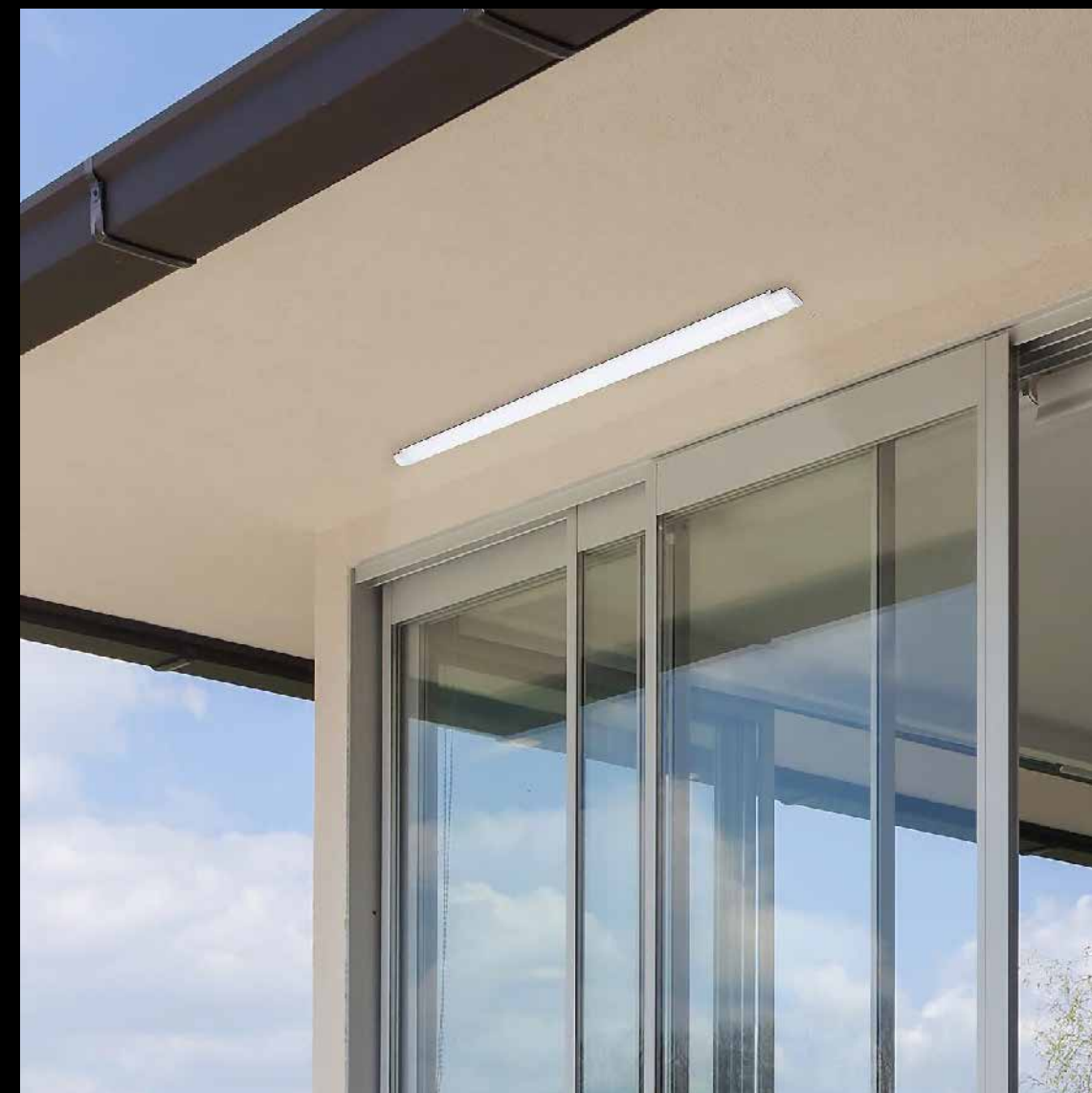
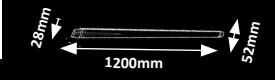

I454 (P)

LED / 20W
(1600lm, 4000K) incl.
IP65
white



5 998250 314549

I455 (P)

LED / 40W
(3200lm, 4000K) incl.
IP65
white



5 998250 314556

FLOOD



7062 (M) (P)

LED / 10W
(1100lm, 4000K)
AC 230V incl. • IP65
black



5 998250 370620

7063 (M) (P)

LED / 20W
(2200lm, 4000K)
AC 230V incl. • IP65
black



5 998250 370637

7064 (M) (P)

LED / 30W
(3300lm, 4000K)
AC 230V incl. • IP65
black



5 998250 370644

7065 (M) (P)

LED / 50W
(5500lm, 4000K)
AC 230V incl. • IP65
black



5 998250 370651

FLOOD



7066 (M) (P)

LED / 10W (900lm, 4000K)
AC 230V incl. • IP44
4-10m, 120°
black



5 998250 370666

7067 (M) (P)

LED / 20W (1800lm, 4000K)
AC 230V incl. • IP44
4-10m, 120°
black



5 998250 370675

7068 (M) (P)

LED / 30W (2700lm, 4000K)
AC 230V incl. • IP44
4-10m, 120°
black



5 998250 370682

L TYPE WORKING DISPLAY
SAP 978



ONE PALLET WORKING DISPLAY
SAP 976



CARTON WORKING DISPLAY

body: SAP 975
crown: code depends on the sample product

HALF PALLET WORKING DISPLAY
SAP 977



L TYPE WORKING DISPLAY
SAP 979

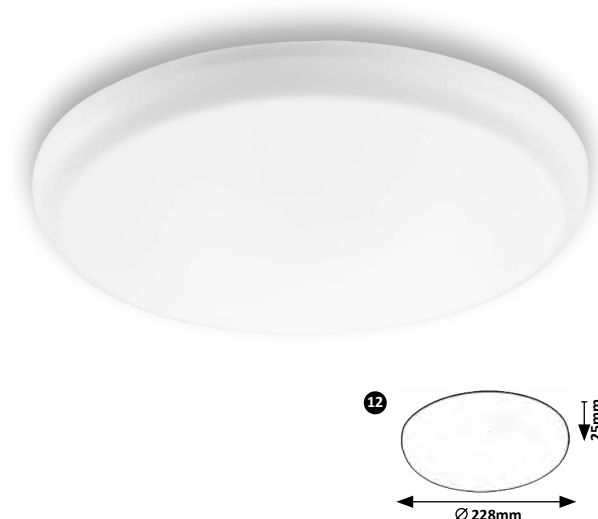

- 1 9999
- 2 M T
- 3 LED / 50W (3080lm, 3000K-6000K) incl.
- 4 E27 / 1x max. 60W
- 5 IP20 • 19500 • 523
- 6 DC 1,2V • 1xAA incl.
- 7 white
- 11 5 998250 362502

- 1 • Item No.
• cikkszám
• Artikelnummer
• no. article
• objednací číslo
• Číslo položky
• nr. artykułu
• номер виробу
• nr. Articol
• Br. Artikla
• broj artikla
• številka artikla / artikel št.
• № на артикул
• elemento Nr.
• izstrādājuma Nr.
• toote Nr.
- 2 • material of the product
• a termék anyaga
• Material des Produkts
• matériau du produit
• materiál výrobku
• Material produktu
• материал виробу
• materialul produsului
• materijal proizvoda
• materijal proizvoda
• material izdelka
• материал на продукта
• produkto medžiaga
• produkta materiāls
• toote materjal
- 3 • technical data of lightsource for lamp
• a lámpához adott fényforrás műszaki adatai
• Technische Daten des Leuchtmittels zur Leuchte
• caractéristiques techniques de l'ampoule du luminaire
• technické údaje světelného zdroje dodávaného s lampou
• technické údaje zdroja svetla priloženého k lampe
• dane techniczne źródła światła dostarczonego z lampą
• технічні дані джерела освітлення для даної лампи
• datele tehnice ale sursei de lumină pentru lampă
• tehnički podaci o izvoru svetlosti za lampu
• tehnički podaci izvora svetlosti koji je priložen uz lampu
• tehnični podatki vira svetlobe za svetilko
• технически данни на източника на светлина, приложен към лампата
• švietuvos šviesos šaltinio techniniai duomenys
• lampas gaismas avota tehniskie dati
• lambi valgusalikka tehnilised andmed
- 4 • the specifications of the lightsource
• a fényforrásra vonatkozó műszaki adatok
• Angaben zur Lichtquelle
• les spécifications de la source lumineuse
• specifikace světelného zdroje
• specifikácie svetelného zdroja
• Specyfikacja źródła światła
• технічні характеристики джерела освітлення
• specificații surse de iluminat
• specifikacije svetlosnog izvora
• specifikacija izvora svetlosti
• specifikacije svetlobnega vira
• характеристики на светлинния източник
• šviesos šaltinio specifikacijos
• gaismas avota specifikācijas
• valgusalikka tehnilised andmed
- 5 • IP protection
• IP védettség
• IP-Klasse
• protection IP
• IP kryti
• IP ochrana
• Stopierń ochrony IP
• Клас IP-захисту
• Protecția IP
• IP zaštita
• IP zaštita
• IP zaštita
• c IP зашита
• IP klase
• IP aizsardzība
• IP kaitse
- 6 • article number of the replacement lampshade
• pótbúra cikkszám
• Artikelnummer des Ersatz-Lampenschirms
• numéro d'article de l'abat-jour de remplacement
• číslo výrobku náhradního stínítka
• číslo výrobku náhradného tienidla
• Numer artykułu wymiennego klosza
• номер виробу запасного абажуру
• număr de articol pentru abajurul înlocuitor
• Br. artikla rezervnog abažuru
• broj artikla zamjenskog sjenila
• številka izdelka nadomestnega senčila
• № на артикул на допълнителен абажур
• rakaitinio lempos gaubto prekės numeris
• rezerves abažūra preces numurs
• asenduslambivarju artiklinumber
- 7 • item number remote controller
• a távirányító cikkszám
• Artikelnummer der Fernbedienung
• numéro d'article de la télécommande
• číslo položky dálkového ovladače
• Číslo položky diaľkového ovládača
• Numer produktu pilota
• Номер елемента дистанційного керування
• Număr articol pe telecomandă
• Broj stavke daljinskog upravljača
• Broj stavke daljinskog upravljača
• Številka izdelka daljinskega upravljalnika
• Каталоген номер на дистанционното управление
• Nuotolinio valdymo pulto prekės numeris
• Tālvadības pults vienuma numurs
• Puldli artiklinumber
- 8 • type of switch
• a kapcsoló típusa
• Typ des Schalters
• type d'interrupteur
• druh vypínače
• druh vypināča
• Typ preračunika
• тип перемикача
• tip de comutator
• tip prekidača
• vrsta prekidača
• vrsta stikala
• тип на ключа
• jungiklio tipas
• slēdža tips
• lüliti tüüp
- 9 • battery specification
• elemmel kapcsolatos információk
• Batteriespezifikation
• spécifications de la pile
• specifikace baterie
• špecifikácia batérie
• Specyfikacja baterii
• специфікація акумулятора
• specificații baterie
• specifikacija baterije
• specifikacija baterije
• specifikacija baterij
• характеристики на батерията
• baterijos specifikacijos
• baterijas specifikācija
• patarei tehnilised andmed
- 10 • colour of the product
• a termék színe
• Farbe des Produkts
• couleur du produit
• barva produktu
• farba produktu
• Kolor produktu
• колір виробу
• culoarea produsului
• boja proizvoda
• boja proizvoda
• barva izdelka
• цвят на продукта
• produkto spalva
• produkta krāsa
• toote värv
- 11 • EAN code
• EAN- kód
• EAN-Code
• code EAN
• EAN- kód
• EAN- kód
• kod EAN
• код EAN
• cod EAN
• EAN kód
• EAN- kod
• EAN koda
• EAN kod
• EAN koda
• EAN kods
• EAN kods
• EAN-kood
- 12 • sizes
• méretek
• Maß
• dimensions
• rozmery
• rozmery
• wymiary
• розміри
• mēriņi
• dimenzije
• dimenzije
• mere
• размери
• išmatavimai
• izmēri
• suurused

DIMMABLE



CCT (CHANGEABLE COLOUR TEMPERATURE)

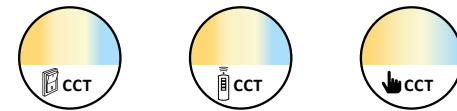

RGB LED



CONTROL VIA WI-FI/BLUETOOTH



IP PROTECTION OF RECESSED LAMPS

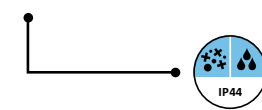
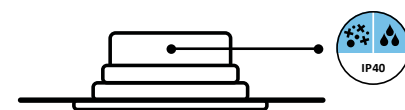

CONNECTIBLE LAMPS

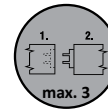
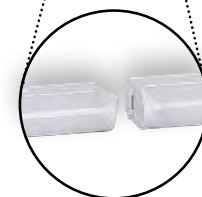

EN: IP RATING

The **IP protection** ensures the operational safety of luminaires. The IP Code (or Ingress Protection Rating) classifies the degrees of protection provided against the ingress of solid objects, dust and water in lamps. The standard aim is to provide users more detailed information than terms such as waterproof. In our catalogue the IP code of each product is indicated. The illustration below shows the recommended IP protection for each zone of wet areas.

HU: IP VÉDELEM

Az **IP védelem** biztosítja a lámpatestek üzembiztonságát. Az IP kód (avagy Ingress Protection) meghatározza a lámpa védelem szintjét idegen testek, por, illetve víz behatolása ellen. Katalógusunkban minden termék IP kódja feltüntetésre került. A lenti ábra a vizes helységek egyes zónáiban ajánlott IP védelem szintjét szemlélteti.

DE: IP-SCHUTZ

Der **IP-Schutz** gewährleistet die Betriebssicherheit der Leuchten. Der IP-Code (oder Ingress Protection) bestimmt die Schutzstufe der Lampe gegen das Eindringen von Fremdkörpern, Staub oder Wasser. In unserem Katalog ist der IP-Code jedes Produkts angegeben. Die folgende Abbildung zeigt den empfohlenen IP-Schutz für jede Zone von Feuchtgebieten.

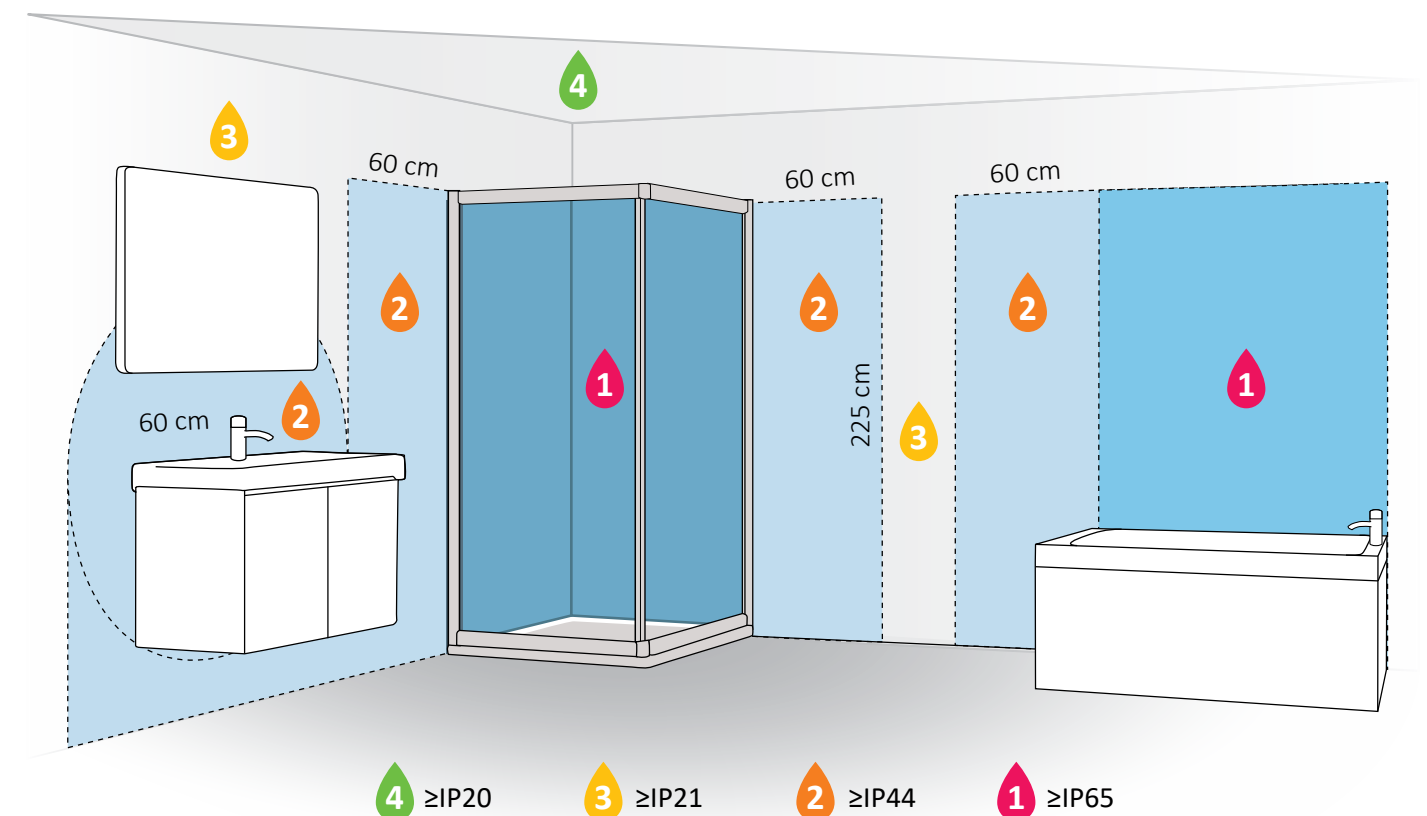

4 ≥IP20 3 ≥IP21 2 ≥IP44 1 ≥IP65

KEY OF SYMBOLS • JELMAGYARÁZAT • ZEICHENERKLÄRUNG



	Key of symbols	Jelmagyarázat	Zeichen- erklärung	Légende	Legenda	Legenda	Objasnienie znaków	позначення умовних
	item number of spare lampshade	pótbúra cikkszám	Artikelnummer Zusatzschirm	no. d'article du globe supplémentaire	položkové číslo náhradního krytu	číslo položky náhradného tienidla	numer indeksu klosza zapasowego	артикульний номер запасного абажура
	external replacement lampshade item number	külső pótbúra cikkszám	Artikelnummer äußerer Zusatzschirm	numéro d'article globe supplémentaire extérieur	položkové číslo vnějšího náhradního krytu	číslo položky vonkajšieho náhradného tienidla	numer indeksu zewnętrznego klosza zapasowego	артикульний номер зовнішнього запасного абажура
	with light source	fényforrással együtt	mit Leuchtmittel	avec source lumineuse	se světelným zdrojem	spolu so svetelným zdrojom	z źródłem światła	разом з джерелом світла
	without light source	fényforrás nélkül	ohne Leuchtmittel	sans source lumineuse	bez světelného zdroje	bez svetelného zdroja	bez źródła światła	без джерела світла
	with switch	kapcsolóval	mit Schalter	avec commutateur	se spínačem	so spínačom	z wyłącznikiem	із перемикачем
	with cable switch	vezetékes kapcsolóval	mit Leitungsschalter	avec commutateur muni de câble	s kabelovým spínačem	so sietovým spínačom	z włącznikiem kablowym	із дровтовим перемикачем
	mounting diameter	beépítési átmérő	Einbaudurchmesser	diamètre encastrement	montážní průměr	priemer zabudovania	średnica montażowa	діаметр для установки
	mounting depth	beépítési mélység	Einbautiefe	profondeur de montage	montážní hloubka	montážna hĺbka	głębokość montażowa	глибина кріплення
	motion sensor	mozgásérzékelő	Bewegungssensor	détecteur mouvement	senzor pohybu	senzor pohybu	czujnik ruchu	датчик руху
	remote controller item number	távirányító cikkszám	Artikelnummer der Fernbedienung	numéro d'article de la télécommande	Číslo položky dálkového ovladače	Číslo položky diaľkového ovládača	Numer produktu pilota	Номер елемента дистанційного керування



	Legendă	Objasnjenje znakova	Tumač znakova	Legenda	Обяснение на условни знаци	Aprašas	Apzīmējumi	Tingmärk
	număr articol abajur suplimentar	oznaka dodatnog abažura	oznaka dodatnog sjenila	kođa dodatnega abažura	резервен абажур артикулен №	atsarginio gaubto prekės Nr.	maiņas abažūra izstrādājuma Nr.	asenduslambikuppel nr
	număr articol abajur suplimentar pentru exterior	oznaka dodatnog spoljnog abažura	oznaka dodatnog vanjskog sjenila	oznaka dodatnega zunanjega abažura	външен резервен абажур артикулен №	išorinio atsarginio gaubto prekės Nr.	ārējā maiņas abažūra izstrādājuma Nr.	vāline asenduslambikuppel nr
	cu sursă de lumină	zajedno sa izvorom svetlosti	zajedno s izvorom svjetlosti	skupaj z virom svetlobe	включително светлинен източник	kartu su šviesos šaltiniu	kopā ar gaismas avotu	koos valgusalikaga
	fără sursă de lumină	bez izvora svetlosti	bez izvora svjetlosti	brez svetlobnega vira	без светлинен източник	be šviesos šaltinio	bez gaismas avota	valgusalikata
	cu întrerupător	sa prekidačem	s prekidačem	s stikalom	с превключвател	su jungikliu	ar slēdzi	lūlitiga
	cu întrerupător pe cablu	sa kablovskim prekidačem	s kablovskim prekidačem	s kabliskim stikalom	с кабелен превключвател	su kabelio jungikliu	ar slēdzi uz vada	sisselūlitamīse juhtmega
	diametru de montare	dimenzije ugradnje	instalacijske dimenzije	dimenzije montaže	диаметър на вграждане	įmontavimo diametras	iebūvēts diametrs	sisseehitatud diameeter
	adâncimea de montare	dubina ugradnje	instalacijske ugradnje	globina montaže	дълбочина на монтаж	įmontavimo gylis	iebūvēts dziļums	sisseehitatud sügavus
	senzor de mișcare	senzor kretanja	senzor kretanja	senzor gibanja	със сензор за движение	judesio jutiklis	kustības sensors	liikumisandur
	Număr articol pe telecomandă	Broj stavke daljinskog upravljača	Broj stavke daljinskog upravljača	Številka izdelka daljinskega upravljalnika	Каталожен номер на дистанционното управление	Nuotolinio valdymo pulto prekės numeris	Tālvadības pults vienuma numurs	Puldi artiklinumber

KEY OF SYMBOLS • JELMAGYARÁZAT • ZEICHENERKLÄRUNG



	Lamp made of	Lámpa anyaga	Lampenmaterial	Le matériel de la lampe	Materiál lampy	Materiál svetidla	Materiał oprawy	Матеріал світильника
	M metal	fém	Metall	métal	kov	kov	metal	метал
	W wood	fa	Holz	bois	dřevo	drevo	drewno	дерево
	G glass	üveg	Glas	verre	sklo	sklo	szkło	скло
	AC acrylic crystal	akril kristály	Acrylkristall	cristal acrylique	akrylový křišťál	akrylový kryšťál	kryształ akrylowy	акриловий криштал
	GC glass crystal	üveg kristály	Glaskristall	cristal de verre	skleněný křišťál	sklo křišťál	kryształ szklany	криштал
	P plastic	műanyag	Kunststoff	plastique	plast	umelá hmota	tworzywo sztuczne	пластмаса
	A acrylic	akril	Acryl	acrylique	akryl	akryl	akryl	акрил
	PA paper	papír	Papier	papier	papír	papier	papier	папір
	C ceramics	kerámia	Keramik	céramique	keramika	keramika	ceramika	кераміка
	T textile	textil	Textil	textile	textil	textília	tkanina	текстиль
	S rock salt	kőszó	Steinsalz	sel gemme	kamenná sůl	kamenná soľ	sól kamienna	кам'яна сіль
	SI silicon	szilikon	Silikon	silicone	silikon	silikón	silikon	силіконові
	PL plaster	gipsz	Stuck	plâtre	sádra	sadra	gips	гіпс
	RA rattan	rattan	Rattan	rotin	ratan	ratan	ratan	ротанг

	Further key	Egyéb magyarázat	Weitere Erklärungen	Autres explications	jiné vysvětlení	druga razlaga	inne wytłumaczenie	інше пояснення
excl.	excluded	nem tartalmaz	exklusive	excepté	neobsahuje	neobsahuje	nie zawiera	не містить
ind.	included	tartalmaz	inklusive	inclus	obsah	obsahuje	zawiera	містить



	Materialul lămpi	Materijal svetiljke	Materijal rasvjetnog tijela	Material izdelka	Лампата е произведена от	Šviestuvo medžiaga	Lampas materiāls	Lambi materjal
	M metal	metal	metal	kovinski	метал	metalinė	metāla	metalli
	W lemn	drven	drvo	les	дърво	medis	koksne	puit
	G sticlă	staklo	staklo	steklo	стъкло	stiklas	stikls	klaas
	AC cristal acrilic	akrilni kristal	akrilni kristal	akrilni kristal	акрилен кристал	akrilinis kristalas	akrila kristāls	akrüülkristall
	GC cristal de sticlă	stakleni kristal	stakleni kristal	stekleni kristal	стъклен кристал	stiklinis kristalas	stikla kristāls	klaaskristall
	P plastic	plastična	plastika	umetna masa	пластмаса	plastikas	plastmasa	plast
	A acril	akril	akril	akril	акрил	akrilas	akrils	akrüül
	PA hirtie	od papira	papir	papir	хартия	popierius	papīrs	paber
	C ceramică	keramika	keramika	keramika	керамика	keramikinis	keramika	keraamika
	T textile	tekstil	tekstil	tekstil	текстиль	tekstilė	tekstilmateriāls	tekstiil
	S sare gemă	kamena so	kamena sol	kamena sol	каменна сол	akmens druska	akmeņšāls	kivisool
	SI silicon	silikon	silikon	silikon	силиконна	silicis	silīcijs	rāni
	PL ghips	gips	žbuka	mavec	гипс	gipsas	ģipsis	kipskrohvisegu
	RA trestie indianā	rattan	rattan	ratan	ратан	rotangas	rotangpalma	rotang

	alte explicații	Druga objašnjenja	Druga objašnjenja	iné vysvetlenie	други обяснения	Kiti simboliai	Citi simboli	Muud sümbrid
excl.	nu conține/nu este inclus	ne sadržava	Ne sadrži	brez (ne vsebuje)	не е включено	neturi	nesatur	ei sisalda
ind.	conține/include	sadržava	sadržava	vsebujejo	включено е	yra su	satur	sisaldab

COLOURS • SZÍNEK • FARBEN



alabaster	alabástrom	Alabasterglas	verre albâtre	alabastrové sklo	alabastrové sklo	szkło alabastrowe	алебастрове скло
amber	borostyán	Bernstein	ambre	jantar	jantár	bursztynowy	бурштиновий
anthracite	antracit	Anthrazit	anthracite	antracitová	antracit	antracyt	антрацитовий
antique bronze	antik bronz	Antik Bronze	bronze antique	antická bronz	antický bronz	brąz antyczny	антична бронза
antique brown	antik barna	Antikbraun	brun antique	antická hnědá	antická hnedá	brąz antyczny	антично коричневий
antique gold	antik arany	Antikgold	or antique	antická zlatá	antická zlatá	złoto antyczne	антично золотий
antique silver	antik ezüst	Antiksilver	argent antique	antický stříbrná	antická stříborná	srebrny antyczny	антично срібний
antique white	antik fehér	Antik Weiß	blanc antique	antikovaná bílá	antická biela	biały antyk	античний білий
beech	bükk	Buche	hêtre	buk	buk	buk	бук
beige	bézs	Beige	beige	bežová	bežová	beżowy	беж
black	fekete	Schwarz	noir	černá	čierna	czarny	чорний
blue	kék	Blau	bleu	modrá	modrá	niebieski	синій
bronze	bronz	Bronzefarbig	bronze	bronzová	bronzová	brąz	бронзовий
brown	barna	Braun	brun	hnědá	hnedá	brązowy	коричневий
brushed aluminium	súrolt alumínium	gebürstetes Aluminium	aluminium brossé	broušený hliník	kartáčovaný hliník	szczerowane aluminium	полірований алюміній
champagne	pezsgő	Champagner	champagne	šampaňská barva	šampanská farba	szampański	колір шампанського
cherry	cseresznye	Kirsche	cerisier	třešeň	čerešňa	czereśniowy	черешня
chrome	króm	Chrome	chrome	chromová	chrómová	chrom	хромовий
claret	bordó	Bordeauxrot	bordeaux	bordó	bordová	bordowy	бордовий
cocoa	kakaó	Kakao	cacao	kakaová	kakao	kakaowy	Какао
coffee	kávė	Kaffeefarben	café	káva	káva	kawa	кава
copper	réz	Kupfer	cuiivre	měděná	medená	miedz	мідь
cream	krém	Cremerfarbig	crème	krémová	krémová	kremowy	крем
crystal	kristály	Kristall	cristal	krystal	kryštál	kryształ	кристал
gold	arany	Gold	dorée	zlatá	zlatá	złoty	золотий
gold foil	arany fólia	Goldfolie	feuille d'or	zlatá fólie	zlatá fólia	złota folia	золота плівка
green	zöld	Grün	vert	zelená	zelená	zielony	зелений

COLOURS • SZÍNEK • FARBEN

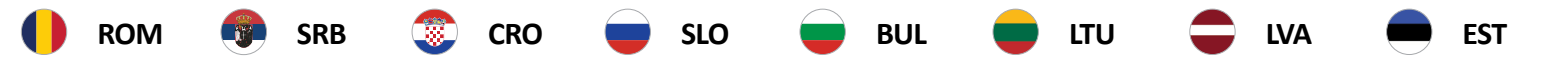

sticlă alabastru	alabastar staklo	alabastar staklo	alabastrno steklo	алабастрово стъкло	rišu akmens stikls	rišu akmens stikls	riisikivi klaas
galben de chihlimbar	bršljan	bršljan	bršljan	кехлибарено	gintaras	dzintars	merevaigukollane
antracit	antracit	antracit	antracitna	антрацитен	antracito pilka	antracīta pelēks	hall antratsiit
bronz antichizat	staro bronzano	antikno bronca	antično bronasta	антично бронзов	antikos bronzinē	antīka bronza	antiik-pronks
maro antic	staro smeđa	staro smeđe	starano rjav	антично кафяв	antikos ruda	antīki brūns	antiik-pruun
auriu antic	staro zlato	staro zlato	staro zlato	антично златен	antikos auksinē	antīks zelts	antiik-kuld
argintiu antic	staro srebro	staro srebro	staro srebro	антично сребърен	antikos sidabrinē	antīks sudrabs	antiik-hõbe
alb antichizat	antik bela	antik bijela	antik bela	антично бяло	antikos balta	antīki balts	antiik-valge
fag	bukva	bukva	bukev	бук	buko	dižskābardis	põök
bej	bež	bež	bež	бежов	smēlio	bešs	beež
negru	crno	crno	črno	черен	juoda	melns	must
albastru	plavo	plavo	modro	син	mēlyna	zils	sinine
bronz	bronzano	brončano	bronasto	бронзов	bronzinē	bronzas	pronks
maro	smeđa	braun	rjavo	кафяв	ruda	brūns	pruun
aluminium şlefuit	brušeni aluminijum	strugani aluminij	brušen aluminij	драскан алуминий	braižyto aliuminio	matēts alumīnijs	harjatud alumiinium
culoarea sampanie	boja şampanjca	boja şampanjca	barva şampanjca	шампанско	şampano	şampanieša krāsa	şampanja
cireş	treşnja	treşnja	čeşnja	череша	vyšnios	ķirsis	kirss
crom	hrom	krom	krom	хром	chrominē	hroms	kroom
bordo	bordo	bordo	bordo	бордо	tamsiai raudona	tumšarkana krāsa	bordoo
cacao	kakao	kakao	kakav	какао	kakavos	kakao	kakao
cafea	kafa	kava	kava	кафе	kafija	kavos	kohv
cupru	bakren	bakren	baker	медна	vario	varš	vask
crem	krem	krem	krem	крем	kreminē	krēma krāsa	koor
cristal	kristal	kristal	kristal	кристал	krištolas	kristāls	kristalne
auriu	zlatno	zlatno	zlato	златен	auksinē	zelta	kuldne
folie aur	zlatna folija	zlatna folija	zlata folija	златно фолио	auksinē folija	zelta folija	kuldne foolium
verde	zeleno	zeleno	zeleno	зелен	žalia	zaļš	roheline

COLOURS • SZÍNEK • FARBEN



grey	szürke	Grau	gris	šedá	šedá	popielaty	сірий
matte black	matt fekete	Mattschwarz	noir mat	matná černá	matná čierna	czarny matowy	матово-чорний
matte white	matt fehér	Mattweiss	blanc mat	matná bílá	matná biela	biały matowy	матово-білий
metal brown	metál barna	Metallbraun	brun métallisé	metal hnědá	hnědá metalíza	brązowy metalik	металево-коричневий
mint	menta	Minzgrün	menthe	mátová	mätová	miętowy	м'ятний
multicolour	többszínű	Multicolor	multicolore	vícebarevná	viacfarebná	wielokolorowy	багатокольниковий
natural	natúr	Naturfarbig	nature	přírodní	přírodná	naturalny	натуральний
oak	tölgy	Eiche	chêne	dub	dub	dąb	дуб
opal glass	opál üveg	Opalglas	verre opal	opálové sklo	opálové sklo	szkło opalizowane	скло опал
orange	narancs	Orange	orange	oranžová	oranžová	pomarańczowy	помаранчевий
purple	lila	Lila	lilas	fialová	fialová	fioletowy	ліловий
red	piros	Rot	rouge	červená	červená	czerwony	червоний
rose	rózsa	Rosa	rose	růžová	ružová	różowy	рожевий
rose gold	rózsáray	Roségold	rose doré	růžové zlato	ružové zlato	różowozłoty	рожеве золото
rust effect	rozsa effekt	Rost Effekt	rouille effet	rezavá efekt	hrdzavá efekt	efekt rdzy	іржавий ефект
satin chrome	szatin króm	Satin-Chromfarbig	chrome satiné	hedvábně lesklá chro- mová	saténová chrómová	chrom satyna	сатиново хромовий
silver	ezüst	Silber	argent	stříbrná	strieborná	srebrny	срібний
silver foil	ezüst fólia	Silberfolie	feuille d'argent	stříbrná fólie	strieborná fólia	srebrna folia	срібна плівка
silver oak	ezüst tölgy	Silbereiche	chêne argenté	stříbrný dub	dub strieborný	srebrny dąb	срібний дуб
tinted colour	füst színű	Rauchfarbig	fumée	dýmová barva	dymová	przydymiony	димчастий
tobacco	dohánybarna	Tabakfarbig	tabac	tabáková	tabako	tabaczkowy	табако
transparent	átlátszó	transparent	transparent	průhledná	priehľadná	przezroczysty	прозорий
transparent crystal	átlátszó kristály	transparent Kristall	cristal transparent	průhledná křišťálová	priesvitný krištál	kryształ przezroczysty	криштал прозорий
walnut	dió	Bisterbraun	noix	ořech	orech	orzechowy	горіх
wenge	sötét barna	Wenge	wenge	hnědočerná, textura dřeva	wenge	wenge	венге
white	fehér	Weiss	blanc	bílá	biela	biały	білий
yellow	sárga	Gelb	jaune	žlutá	žltá	żółty	жовтий

COLOURS • SZÍNEK • FARBEN



gri	sivo	sivo	sivo	сив	pilka	pelēks	hall
mat negru	mat crno	mat crno	mat črno	мат-черен	matiné juoda	matēti melns	matt must
mat alb	mat belo	mat bijelo	medlobel	мат-бял	matiné balta	matēti balts	matt valge
brun metalizat	metalno braon	metalno smeđa	metalno rjava	кафяв металик	metalinė ruda	metāla brūns	metallikpruun
mentă	menta	menta	meta	мента	métinė	piparmētru	münt
multicolor	višebojno	višebojno	večbarvno	многоцветен	įvairiaspalvė	daudzkrāsains	mitmevärviline
natur	natur	natur	naravno	натурален	natūrali	dabisks	loomulik
stejar	hrast	hrast	hrast	дъб	ąžuolo	ozols	tamm
sticlă opal	opal staklo	opal staklo	opalno steklo	опалово стъкло	opalinio stiklo	opāla stikls	opaalklaas
portocaliu	narandžasto	narandža	oranžno	оранжев	oranžinė	oranžs	oranž
violet	ljubičasto	ljubičasto	vijoličasto	лилав	violetinė	violets	lilla
roșu	crveno	crveno	rdeče	червен	raudona	sarkans	punane
trandafir	roza	roza	roza	розов	rožinė	sārts	roos
trandafiriu-auriu	ružičasto zlatno	ružičasto zlatna	rose (čebulna) barva	розовозлатна	rožinė auksinė	sārti zeltains	roos-kuldne
rugină efect	rđa efekat	hrđa efekat	videz rje	с ефект на ръжда	rūdžių efektas	rūsas efekts	rooste efekt
crom satin	saténasti hrom	saténasti krom	saténast krom	сатенен-хром	atlaso chrominė	satīna hroms	satiin-kroom
argintiu	srebrno	srebrno	srebrno	сребърен	sidabrinė	sudraba	hõbe
folie argint	srebrna folija	srebrna folija	srebrna folija	сребърно фолио	sidabrinė folija	sudraba folija	hõbedane foolium
stejar argintiu	srebrni hrast	srebrni hrast	srebrni hrast	сребърен дъб	sidabrinis ąžuolas	sudraba ozols	hõbemänd
fumuriu	boje dima	indigo plava	barva dima	прозиращо кафяво	su atspalviu	tonēta krāsa	toonitud värv
tabaco	tabaco	tabaco	barva tobaka	тютюнев (табако)	tabako	tabakas	tubakas
transparent	providan	proziran	prozorno	прозрачен	skaidri	caurspīdīgs	läbipaistev
cristal transparent	providan kristal	proziran kristal	prozoren kristal	прозрачен кристал	permatomo krištolo	caurspīdīgs kristāls	läbipaistev kristall
nucă	orah	orah	oreh	орех	riešutmedžio	valrieksta	pähklipuu
wenge	wenge	wenge	venge	венге	tamsiosios miletijos	wenge	wenge
alb	belo	bijelo	belo	бял	balta	balts	valge
galben	žuto	žuto	rumeno	жълт	geltona	dzeltens	kollane

KEY OF SYMBOLS • JELMAGYARÁZAT • ZEICHENERKLÄRUNG



GBR



HUN



GER



FRA



CZE

	Symbols	Jelölések	Bezeichnungen	Symboles	Jména
	new	új	neu	nouveau	nový
	designed by Rabalux	Rábalux saját design	entworfen von Rabalux	conçu par Rabalux	Rabalux vlastní design
	additional products/family members can be found on page X.	kiegészítő termékek/további családtagok az X. oldalon	weitere Produkte (der Serie) finden Sie auf Seite X.	des produits/membres de la famille supplémentaires se trouvent à la page X.	další produkty/členy rodiny naleznete na straně X.
	X years guarantee	X év garancia	X Jahre Garantie	X ans de garantie	záruka X let
	built-in LED	beépített LED	LED inklusive	LED inclus	obsahuje LED
	LED included	LED-et tartalmaz	LED inklusive	LED inclus	obsahuje LED
	Smart product	okos termék	intelligentes Produkt	produit intelligent	chytrý produkt
	warm white light	meleg fehér fényű	warmweiß	blanc chaud	teplá bílá
	natural white light	természetes fehér fényű	naturweiß	blanc naturel	přirozená bílá
	cool white light	hideg fehér fényű	kaltweiß	blanc froid	studená bílá
	colour temperature variable with remote control	távírányítóval állítható színhőmérséklet	mit fernbedienung einstellbare Farbtemperatur	Température de couleur réglable par télécommande	Nastavení teploty chromatičnosti dálkovým ovladačem
	colour temperature variable with switch	kapcsolóval állítható színhőmérséklet	mit Schalter einstellbare Farbtemperatur	température de couleur réglable avec interrupteur	spínačem nastavitelná teplota chromatičnosti
	colour temperature variable with touch switch	érintőkapcsolóval állítható színhőmérséklet	mit Berührungsschalter einstellbare Farbtemperatur	température de couleur variable avec interrupteur tactile	změna teploty barvy světla pomocí dotykového spínače
	with switch	kapcsolóval	mit Schalter	avec commutateur	se spínačem
	adjustable brightness in 3 steps with switch	kapcsolóval 3 lépésben szabályozható fényerő	einstellbare Helligkeit mit Schalter in 3 Stufen	Luminosité ajustable avec interrupteur à 3 positions	Nastavitelný jas pomocí spínače ve 3 krocích
	adjustable brightness in 3 steps with touch switch	érintőkapcsolóval több lépésben szabályozható fényerő	einstellbare Helligkeit mit Touch-Schalter in 3 Stufen	Luminosité ajustable avec interrupteur tactile à 3 positions	Nastavitelný jas s dotykovým spínačem ve 3 krocích
	with touch switch	érintőkapcsolóval	mit Berührungsschalter	avec interrupteur tactile	dotykový spínač

KEY OF SYMBOLS • JELMAGYARÁZAT • ZEICHENERKLÄRUNG



SVK



POL



UKR



ROM



SRB

	Označenia	Oznaczenia	Позначення	Simboluri	Označavanje
	Nový	nowy	новий	nou	novo
	Rabalux vlastní dizajn	Zaprojektowano przez Rabalux	розроблений Rabalux	designed de Rabalux	Rabalux dizajn
	ďalšie produkty/členy rodiny nájdete na strane X.	produkty dodatkowe/z tej samej linii można znaleźć na stronie X.	додаткові товари/членів сім'ї можна знайти на сторінці X.	produse suplimentare/membri ai familiei pot fi găsite la pagina X.	Informacije o dodatnim proizvodima/elementima palete proizvoda dostupne su na strani X.
	Záruka X rokov	X-letnia gwarancja	гарантія X років	X ani garanție	X godina garancije
	obsahuje LED diódy	Dioda LED w wyposażeniu	містить світлодіоди	LED încorporat	ugrađeni LED
	obsahuje LED diódy	Dioda LED w wyposażeniu	містить світлодіоди	LED inclus	sa LED diodom
	inteligentný produkt	inteligentny produkt	розумний продукт	produs inteligent	паметан производ
	teplá biela	ciepła biała	теплий білий	alb cald	toplo bela
	prírodná biela	naturalna biała	натуральний білий	alb natural	prirodno bela
	studená biela	zimna biała	холодний білий	alb rece	hladno bela
	Možnosť nastavenia teploty farieb s diaľkovým ovladačom	Zmienna temperatura barwowa za pomocą pilota	Регулювання колірної температури через пульт дистанційного керування	Temperatura culorii reglabilă de la telecomandă	Sa daljinskim prekidačem može da se podesi temperatura boja
	možnosť nastavenia teploty farieb spínačom	temperatura barwy regulowana wyłącznikiem	колірна температура, регульована перемикачем	temperatura culorii controlată cu comutator	temperatura boja može da se podesi sa prekidačem
	nastavitelná farebná teplota s dotykovým spínačom	Regulacja temperatury światła za pomocą włącznika dotykowego	Колір світла змінюється доторканням	temperatura variabilă a culorii cu comutator tactil	Temperatura svetla, podesiva putem prekidača na dodir
	so spínačom	z włącznikiem	із перемикачем	cu întrerupător	sa prekidačem
	Nastavitelný jas pomocou spínača v 3 krokoch	Jasność dostosowywana przełącznikiem w 3 krokach	Регульована яскравість з перемикачем в 3 кроки	Luminozitate ajustabilă prin comutator în 3 trepte	Podesimo osvetljenje u 3 koraka uz pomoć prekidača
	Nastavitelný jas s dotykovým spínačom v 3 krokoch	Jasność dostosowywana dotykowo w 3 krokach	Регульована яскравість з сенсорним перемикачем в 3 кроки	Luminozitate ajustabilă prin atingere, în 3 trepte	Podesimo osvetljenje u 3 koraka uz pomoć prekidača koji se aktivira dodir
	s dotykovým spínačom	ze ściemniaczem	із сенсорним перемикачем	cu senzor tactil	sa prekidačem na dodir

KEY OF SYMBOLS • JELMAGYARÁZAT • ZEICHENERKLÄRUNG



	Oznake	Oznake	Символи	Simboliai	Simboli	Sümbolid
	novo	novo	ново	naujas	jauns	uus
	dizajnirao Rablux	zasnoval Rabalux	проектирано от Rabalux	suprojektavo „Rabalux“	izstrādājis Rabalux	Rabaluxi disain
	dotatne proizvode/ članove obitelji moguće je pronaći na stranici X.	dotatne izdelke/družinske člane najdete na strani X.	допълнителни продукти/ членове на семейството могат да бъдат намерени на страница X.	papildomų prekių/šeimos narių rasite X puslapyje.	papildu produktus/sērijas modelus var atrast X lapā.	Leiate lisatooted ja sama tootepere muud tooted leheküljelt X.
	X godina jamstva	X let garancije	X години гаранция	X metų garantija	X gadu garantija	X-aastane garantii
	ugrađeni LED	vgrajen LED	вграден LED	įmontuotas LED įrenginys	iešvūvēta LED	sisse-ehitatud LED
	sadrži LED	vsebuje LED	с включен LED	LED pridedama	LED iekļauta komplektā	LED on kaasas
	pametnan proizvod	pameten izdelek	интелигентен продукт	protingas produktas	gudrs produkts	tark toode
	toplo bijelo	toplo bela	топло бяло	šiltai balta	silti balts	soe valge
	priradno bijelo	naravno bela	естественно бяло	natūraliai balta	dabīgi balts	loomulik valge
	hladno bijelo	hladno bela	студено бяло	šaltai balta	vēsi balts	kūlm valge
	Pomoću daljinskog prekidača možete podesiti temperaturu boje	Barvno temperaturo lahko nastavite z daljinskim stikalom	Регулиране на цветната температура с дистанционно управление	Kintanti spalvinė temperatūra su nuotoliniu pulteliu	Maināma krāsu temperatūra ar tālvadības pulti	Muutuv värvustemperatuur kaugjuhtimisega
	temperatura boja se može podesiti s prekidačem	barvna temperatura nastavljava s stikalom	регулируема с ключ светлинна температура	jungikliu keičiama spalvos temperatūra	ar slēdzi maināma krāsu temperatūra	lūlitīga regulēritav värvtemperatuur
	Temperatura boje podesiva prekidačem na dodir	sprememba barvne temperature s stikalom na dotik	промянана на цветната температура с докосване	Prilietimu keičiama spalvos temperatūra	Krāsu temperatūras mainīgais ar skārienekrānu	puutelūlitist muudetav värvtemperatuur
	s prekidačem	s stikalom	с превключвател	su jungikliu	ar slēdzi	lūlitīga
	Prilagodljiva svjetlina s prekidačem u tri koraka	Prilagodljiva svetlost s stikalom v 3 korakih	Регулируема яркост с ключ на 3 степени	Ryškumas reguliuojamas su jungikliu 3 žingsniais	Trīs līmeņu regulējams spilgtums ar slēdzi	Lūlitist 3-astmeliselt regulēritav heledus
	Prilagodljiva svjetlina s dodirnim prekidačem u tri koraka	Prilagodljiva svetlost s stikalom na dotik v 3 korakih	Регулируема яркост с докосване на 3 степени	Ryškumas reguliuojamas su jutikliniu jungikliu 3 žingsniais	Trīs līmeņu regulējams spilgtums ar skārienjūtīgu slēdzi	Puutelūlitist 3-astmeliselt regulēritav heledus
	s dodirnom sklopkom	z stikalom na dotik	със сензорен превключвател	liečiamasis jutiklis	skārienjutīgs slēdzis	puutetundlik lūliti

KEY OF SYMBOLS • JELMAGYARÁZAT • ZEICHENERKLÄRUNG



	Symbols	Jelölések	Bezeichnungen	Symboles	Jména	Označenia
	touch switch dimmer	érintőkapcsolóval szabályozható fényerő	Touchbutton-Lichtstärkeregler	réglage de la luminosité avec interrupteur tactile	nastavení jasu dotykovým spínačem	dotykový spínač na regulácia intenzity svetla
	light intensity variable only with remote control	csak távirányítóval állítható fényerő	Lichtintensität nur mit Fernbedienung einstellbar	intensité lumineuse variable uniquement avec télécommande	intenzitu svetla lze nastavit pouze pomocí dálkového ovládání	možnosť nastavenia intenzity svetla iba s diaľkovým ovládačom
	dimmable	szabályozható fényerő	Lichtstärke Regler	Regleur d'intensité de la lumière	regulátor jasu	regulátor jasu
	RGB colour change LED	RGB színváltós LED	Farbwechsel-LED	LED à changement de couleurs	LED diody střídající barvu	LED s meniacou sa farbou
	Magic RGB	Magic RGB	Magic RGB	RGB magique	Kouzelné RGB	Kúzelné RGB
	motion sensor	mozgásérzékelő	Bewegungssensor	détecteur mouvement	senzor pohybu	senzor pohybu
	ON/OFF motion sensor	BE/KI kapcsolható mozgásérzékelő	EIN/AUS Bewegungssensor	Détecteur de mouvement ON/OFF	ZAP./VYP. pohybový senzor	ZAP./VYP. Pohybový senzor
	microwave sensor	mikrohullámú mozgásérzékelő	Mikrowellen-Sensor	Capteur à micro-ondes	mikrovlnný snímač	Mikrovlnný snímač
	illuminates upwards	felfelé világít	leuchtet nach oben	éclaire vers le haut	svítí nahoru	svieti nahor
	illuminates downwards	lefelé világít	leuchtet nach unten	éclaire vers le bas	směr svícení dolů	svieti smerom dole
	illuminates downwards and upwards	lefelé és felfelé is világít	leuchtet nach oben und nach unten	éclaire vers le bas et vers le haut	směr svícení nahoru i dolů	svieti smerom dole aj hore
	light reactive, only illuminates in the dark	fényérzékelő lámpa, csak sötétben világít	mit Helligkeitssensor, leuchtet nur im Dunkeln	l'appareil est muni d'un photodétecteur, il ne se manifestera que s'il est plongé dans l'obscurité	se světelným senzorem, svítí pouze ve tmě	so svetelným senzorem, svieti iba v tme
	UV resistant plastic	UV álló műanyag	UV-beständiger Kunststoff	plastique résistant à l'UV	plast odolný UV záření	plast odolný UV žiareniu
	lamp operating with solar cells	napelemmel működő lámpa	Leuchte funktioniert über Solarzellen	luminaire fonctionnant avec une cellule photovoltaïque	svítidlo na solární baterii	plast odolný UV
	IP protection	IP védettség	IP-Klasse	protection IP	IP krytí	IP ochrana
	IP protection of built-in lamp	beépített lámpa IP védelme	IP-Schutz der eingebauten Lampe	protection IP de la lampe intégrée	IP krytí zabudovaného svítidla	IP ochrana zabudovanej lampy
	Phone App Controllable	telefonos applikációval vezérelhető	steuerbar über Telefon-App	Contrôlable via Téléphonique App	Lze ovládat aplikací v telefonu	Možno ovládat aplikáciou v telefóne

KEY OF SYMBOLS • JELMAGYARÁZAT • ZEICHENERKLÄRUNG



POL



UKR



ROM



SRB



CRO

	Oznaczenia	Позначення	Simboluri	Označavanje	Oznake
	ściemniacz dotykowy	сенсорний диммер	senzor tactil pentru reglarea luminozității	podešavanje jačine svetlosti sa prekidačem na dodir	podešavanje svjetline pomoću dodirne sklopke
	natężenie światła regulowane tylko przy pomocy pilota	інтенсивність світла регулюється тільки за допомогою пульта	Intensitate variabilă a luminii numai de la telecomandă	Intenzitet svetlosti podesiv samo uz pomoć daljinskog upravljača	jačina svjetla promjenjiva samo sa daljinskim upravljačem
	regulator natężenia światła	регулятор потужності світла	regulator intensitate lumina	regulator svetlosti	regulator jače svjetla
	Zmieniający kolor LED	Світлодіоди зі зміною кольору	LED RGB	LED sa promjenjivim bojama	LED s promjenjivim bojama
	Magia RGB	Чарівний RGB	RGB Magic	Magic RGB funkcija	Čarobni RGB
	czujnik ruchu	датчик руху	senzor de mișcare	senzor kretanja	senzor kretanja
	WŁ/WYŁ Czujnika ruchu	Вкл./Викл. датчик руху	Senzor de mișcare ACTIVARE/DEZACTIVARE	Uključen/isključen senzor pokreta	UKLJUČIVANJE/ISKLUČIVANJE senzora pokreta
	Mikrofalowy czujnik ruchu	Мікрохвильовий датчик	Senzor cu microunde	Mikrotalasni senzor	Mikrovalni senzor
	świeci do góry	світиться вгору	iluminează în sus	svetli prema gore	osvjetljava prema gore
	świeci w dół	напрям світла донизу	luminează în jos	nadole svetli	svijetli nadolje
	świeci w dół i w górę	напрям світла донизу і догори	luminează în jos și în sus	svetli i nagore i nadole	svijetli i nadolje i nagore
	z czujnikiem oświetlenia, świeci tylko w ciemności	оснащений світловим вмикачем, включається тільки при зниженні інтенсивності освітлення	cu sensor, luminează doar în întuneric	osetljiv na svetlost, svetli samo u mraku	osjetljiv na svjetlost, svijetli samo u mraku
	tworzywo sztuczne odporne na UV	УФ-стійкий пластик	material plastic rezistent la UV	UV otporna plastika	Plastika otporna na UV zrake
	lampa zasilana energią słoneczną	лампа на сонячній батареї	lampă cu acumulator solar	solarna lampa	solarna svjetiljka
	Stopień ochrony IP	Клас IP-захисту	Protecția IP	IP zaštita	IP zaštita
	wbudowana ochrona IP	IP-захист вбудованої лампи	Protecția IP a lămpii încorporate	IP zaštita ugrađene lampe	IP zaštita ugrađene svjetiljke
	Możliwość obsługi przez aplikację	Можливість керування за допомогою мобільного додатку	Controlabil prin aplicație mobilă	Kontrola preko telefonske aplikacije	Telefonska aplikacija kojom je moguće upravljati

KEY OF SYMBOLS • JELMAGYARÁZAT • ZEICHENERKLÄRUNG



SLO



BUL



LTU



LVA



EST

	Oznake	Символи	Simboliai	Simboli	Sümbolid
	Prilagodite svetlost z stikalom na dotik	регулятор на яркостта със сензорен превключвател	liečiamasis pritemdymo jutiklis	skārienjutīgs gaismaīna slēdzis	puuetundlik valgusregulaator
	možnost nastavitve jakosti svetlobe samo z daljinskim upravljanjem	димирание само чрез дистанционно управление	tik šviesos stiprio kintamasis su nuotolinio valdymo pultu	gaismas intensitāte mainīga tikai ar tālvadības pulti	valguse intensiivsust saab reguleerida ainult kaugjuhtimispuhli abil
	zatemnilnik	с регулятор за силата на светлина	pritemdymo įtaisas	gaismmainis	hämardi
	LED diode s spremenljivim barvama	LED с променлива светлина	Spalvą keičiantis LED	Maināmas krāsas LED	Värvi vahetav LED
	Magic RGB	Магическа RGB светлина	Stebuklingas RGB	Maģiskais sarkanajzilais krāsu modelis	Magic RGB
	senzor gibanja	със сензор за движение	judesio jutiklis	kustības sensors	liikumisandur
	VKLOP/IZKLOP Sensorja gibanja	ВКЛЮЧВАНЕ/ИЗКЛЮЧВАНЕ със сензор за движение	ON/OFF judesio jutiklis	IESLĒGŠANAS/IZSLĒGŠANAS kustību sensors	Liikumisanduriga sisse ja välja lülitamine
	Mikrovalovni senzor	Микровълнов сензор	Mikrobangų jutiklis	Mikrovļņu sensors	Mikrolaineandur
	sveti navzgor	свети нагоре	šviesa nukreipta į viršų	iedegas uz augšu	valgustab ülespoole
	svetli navzdol	осветява надолу	šviečia žemyn	apgaismo lejup	valgustab allapoole
	svetel in gor in dol	осветява надолу и нагоре	šviečia žemyn ir aukštyn	apgaismo lejup un augšup	valgustab alla- ja ülespoole
	občutljivo na svetlobo, sveti le v temi	реагира на светлина, светва само, когато е тъмно	reaguoja į šviesą, užsidega tik tamsoje	reaģējošs uz gaismu, apgaismo tikai tumsā	valgusreaktiivne, valgustab vaid pimedas
	Plastika UV-odporen	устойчива на UV лъчи пластмаса	UV atsparus plastikas	pret UV stariem noturīga plastmasa	UV-kindel plastik
	sončna svetilka	лампа, работеща със слънчеви батерии	veikia su saulės energijos skydeliu	darbojas ar saules bateriju	sisselülitamine päikeseelemendiga
	IP zaščita	с IP защита	IP klasė	IP aizsardzība	IP kaitse
	IP zaščita vgrajene svetilke	IP защита на вградена лампа	IP saugumo lygio įmontuotas šviestuvas	iebvētās lampas IP aizsardzība	sisse-ehitatud valgusti IP-kaitse
	Upravljanje s telefonsko aplikacijom	Може да се управлява от приложение за телефон	Telefona programėlė Kontroluojama	To var kontrolēt ar tālruna lietojumprogrammu	Mobiiliäpiga juhitav

KEY OF SYMBOLS • JELMAGYARÁZAT • ZEICHENERKLÄRUNG



GBR



HUN



GER



FRA



CZE

Symbols	Jelölések	Bezeichnungen	Symboles	Jména
Remote Control Range 5-7 meters	távírányító hatótávolság 5-7 méter	Fernbedienung Reichweite 5-7 Meter	Télécommandes Portée de 5-7 mètres	Dosah dálkového ovládače 5-7 metrů
IR - InfraRed Remote Control	IR - infravörös távírányító	IR - Infrarot-Fernbedienung	IR - Télécommande Infrarouge	IR - Infračervené dálkové ovládání
Factory-Set Pairing - no pairing needed by customer	Gyárilag Párosítva - vevőnek már nem kell párosítani	Werkseitig eingestelltes Pairing - kein Pairing durch den Kunden erforderlich	Appairage réglé en usine - aucun appairage nécessaire pour le client	Párování nastavené ve výrobě - zákazník nepotřebuje žádné párování
Remote and/or Phone App Controllable	Távírányítóval és/vagy telefonos applikációval is vezérelhető	Steuerbar über Fernbedienung und/oder Telefon-App	Contrôlable par la Télécommande et/ou via Téléphonique App	Ovladatelné dálkově a/nebo aplikací v telefonu
Remote Control can be paired with up to 30 products simultaneously	A távírányító egyszerre max. 30 db termékkel párosítható	Die Fernbedienung kann mit bis zu 30 Produkten gleichzeitig gepaart werden	La télécommande peut être jumelée à 30 produits simultanément	Dálkové ovládání lze spárovat až s 30 produkty současně
fan	ventilátor	Ventilator	ventilateur	ventilátor
fan adjustable in 6 steps	6 lépésben állítható ventilátor	Lüfter in 6 Stufen einstellbar	Ventilateur réglable en 6 étapes	Ventilátor nastavitelný v 6 stupních
ventilator variable with 3 steps	3 lépésben állítható ventilátor	Ventilator in 3 Stufen schaltbar	ventilateur variable à 3 étapes	Ventilátor má 3 úrovně výkonu
ventilator with timer function	ventilátor időszító funkcióval	Ventilator mit Zeiteinstellung	Ventilateur avec une fonction minuterie	Ventilátor s funkcí časovače
textile cable	textil kábel	Textilkabel	Câble en tissu	Textilní kabel
separately switchable light sources	fényforrások külön kapcsolhatóak	Lichtquellen sind extra schaltbar	sources lumineuses changeable séparément	samostatně přepínatelné
indirect light	indirekt fény	mit indirektem Licht	à lumière indirecte	s nepřímým světlem
backlight effect	háttérfény	Hintergrundlichteffekt	effet de contre-jour	efekt podsvícení
mirror	tükör	Spiegel	miroir	zrcadlo
wood	fa	Holz	bois	dřevo
plaster	gipsz	Stuck	plâtre	sádra
Velvet	Bársony	Samt	Velous	Samet

KEY OF SYMBOLS • JELMAGYARÁZAT • ZEICHENERKLÄRUNG



SVK



POL



UKR



ROM



SRB

Označenia	Oznaczenia	Позначення	Simboluri	Označavanje
Dosah diaľkového ovládača 5-7 metrov	Zasięg Pilotu 5-7 metrów	Радіус дії пульта дистанційного керування 5-7 метрів	Telecomandă Rază de acțiune 5-7 m	Domet daljinskog upravljača 5-7 m
IR - Infračervené diaľkové ovládanie	IR - Pilot na Podczerwień	ІЧ - інфрачервоний пульт дистанційного керування	IR - Telecomandă cu infraroșu	IC - Infracrveni daljinski upravljač
Párovanie nastavené vo výrobe - zákazník nepotrebuje žiadne párovanie	Parowanie Ustawione Fabrycznie - brak konieczności parowania	Заводське налаштування приєднання - приєднання не потрібно клієнту	Asociere setată din fabrică - nu este necesară asocierea de către client	Fabričko sparivanje - korisnik ne mora da sprovedi sparivanje
Ovládateľné diaľkovo a/alebo aplikáciou v telefóne	Sterowanie Zdalne i/lub przez Aplikację	Можливість керування за допомогою пульта дистанційного керування та/або мобільного додатку	Controlabil prin telecomandă și/sau aplicație pentru telefon	Mogućnost kontrole daljinskim upravljačem i/ili aplikacijom telefona
Diaľkové ovládanie je možné spárovať až s 30 produktmi súčasne	Pilot może być sparowany jednocześnie z maksymalnie 30 urządzeniami	Пульт дистанційного керування може бути приєднаний одночасно до 30 пристроїв	Telecomanda poate fi asociată simultan cu până la 30 de produse	Daljinski upravljač može da se spari sa do 30 proizvoda istovremeno
ventilátor	wentylator	вентилятор	ventilator	ventilator
Ventilátor nastaviteľný v 6 stupňoch	Wentylator regulowany w 6 stopniach	Вентилятор регулируется на 6 ступеней	Ventilator ajustabil în 6 trepte	Izbor jedne od 6 brzina ventilatora
3-stupňový nastaviteľný ventilátor	3 poziomy pracy wentylatora	Вентилятор перемикається у 3 кроки	ventilator variabil cu 3 trepte de viteza	Ventilator, podesiv u 3 koraka
Ventilátor s funkciou časovača	Wentylator z funkcją timera	Вентилятор з функцією таймера	Ventilator cu funcție de temporizare	Ventilator sa tajmerom
Textilný kábel	Kabel tekstylny	Текстильный кабель	Cablu cu teacă textilă	Tekstilni kabl
samostatne prepínateľné	Możliwość zastosowania podwójnego wyłącznika	Джерела світла перемикаються окремо	comutabil separat	Odvojeno paljenje
s nepriamym svetlom	ze światłem pośrednim	з непрямим освітленням	cu lumină indirectă	sa indirektnim svetlom
efekt podsvietenia	efekt podświetlenia	ефект підсвічування	efect iluminare de fundal	pozadinsko osvetljenje
Zrkadlo	lustro	дзеркало	oglinďă	ogledalo
Drevo	Drewno	дерево	lemn	drven
sadra	gips	гипс	ghips	gips
zamat	Aksamit	Оксамит	catifea	tekstil/pliš

KEY OF SYMBOLS • JELMAGYARÁZAT • ZEICHENERKLÄRUNG

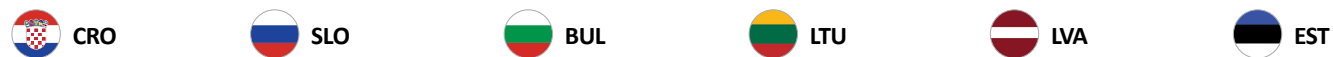

Oznake	Oznake	Символи	Simboliai	Simboli	Sümbolid
Daljinski upravljač Domet 5-7 metara	Doseg daljinskega upravljalnika 5-7 metrov	Обхват на дистанционното управление 5-7 метра	Nuotolinio valdymo atstumas 5-7 metrai	Tālvadības pults darbības rādiuss: 5-7 metri	Kaugjuhtimispuht tööulatusega 5-7 meetrit
IR - infracrveni daljinski upravljač	IR - infrardeči daljinski upravljalnik	IR - инфрачервено дистанционно управление	IR - infraraudonųjų spindulių nuotolinio valdymo pultas	IR - infrasarkanā tālvadības pults	Infrapunakaugjuhtimispuht
Tvornički namješteno uparivanje - korisnik ne mora uparivati	Tovarniško nastavljeno seznanjanje - kupcu ni treba seznanjati	Фабрично настроено двояване - не е необходимо двояване от клиента	Gamykloje nustatytas susiejimas - klientui susieti nereikia	Rūpnīcas iestatījuma savienošana pāri - klientam nav nepieciešams savienot pāri	Tehases paaristatud - kliendil ei ole vaja seadmeid ise paaristada pāri
Može se kontrolirati daljinski i/ili pomoću telefonske aplikacije	Upravljanje na daljavo in/ ali s telefonsko aplikacija	Може да се управлява от дистанционно управление и/или приложение за телефон	Valdoma nuotoliniu būdu ir (arba) telefono programėle	Vadāms ar tālvadības pulti un/vai tālruna lietotni	Juhitav puldi ja/või mobiilipiga
Daljinski upravljač može se istovremeno upariti s do 30 proizvoda	Daljinski upravljalnik lahko seznanite z do 30 izdelki hkrati	Дистанционното управление може да бъде двояно с до 30 продукта едновременно	Nuotolinio valdymo pultas vienu metu gali būti susietas su iki 30 gaminių	Tālvadības pulti var savienot pāri ar līdz pat 30 produktiem vienlaikus	Kaugjuhtimispuht saab olla korraga paaristatud kuni 30 tootega
ventilator	ventilator	вентилатор	ventiliatorius	ventilators	ventilaator
Ventilator prilagodljiv u 6 koraka	Ventilator je nastavljen u 6 korakih	Вентилаторът се регулира на 6 степени	Ventiliatorius, reguliuojamas 6 veiksmis	6 soļos regulējams ventilators	6-astmeliselt reguleeritav ventilaator
Ventilator se može koristiti u 3 brzine	sprememba hitrosti ventilatorja s 3 koraki	Вентилаторът може да се превключва на 3 стъпки	Trijų pakopų ventiliatorius sukimosi greičio valdymas	Ventilatora mainīgais ar 3 pakāpieniem	3 töökiirusega ventilaator
Ventilator za podešavanje vremena	Ventilator s funkcijom časovnika	Вентилатор с функция таймер	Ventiliatorius su laikmačio funkcija	Ventilators ar taimera funkciju	Taimerifunktsiooniga ventilaator
Tekstilni kabel	Tekstilni kabel	Текстилен кабел	Tekstile vilktas laidas	Vads ar tekstilmateriālu pārklājumu	Tekstiilkaabel
Izvori svjetlosti se mogu uključiti odvojeno	ločen preklop virov svetlobe	Отделно превключване	Atskirai perjungiamas	Atsevišķi pārslēdzams	eraldi lülitatavad valgusallikad
s neizravnim svjetlom	s posredno svetlobo	с индиректна светлина	su netiesiogine šviesa	ar netiešu gaismu	kaudvalgusega
efekt pozadinskog svjetla	učinek osvetlitve	ефект на подсветка	foninio apšvietimo efektas	aizmugurapgaismojuma efekts	tagantvalgustuse efekt
Zrcalo	zrcalo	огледало	dubliuojamasis tomas	spogulis	peegel
drvo	les	дърво	medis	koksne	puit
žbuka	mavec	гипс	gipsas	ģipsis	kipskrohvisegu
Baršun	Velvet	Кадифе	Velvetas	Samta	Velvet

KEY OF SYMBOLS • JELMAGYARÁZAT • ZEICHENERKLÄRUNG



Symbols	Jelölések	Bezeichnungen	Symboles	Jména	Označenia
metal black	metál fekete	metallschwarz	métal noir	kovově černá	kovovo čierna
shiny	fényes	glänzend	brillant	lesklé	lesklé
soft touch	puha szilikon	sanfte Berührung	toucher doux	jemný dotyk	jemný dotyk
starlight effect	csillogó effekt	Glitzereffekt	effet scintillant	efekt jiskření	efekt iskrenia
timer function	időzítő funkció	mit einer Zeitfunktion	avec fonction de temps	s časovačem	s časovačom
night light function	éjszakai funkció	Nachtfunktion	fonction nuit	funkce nočního světla	funkcia nočného svetla
memory function	memória funkció	Speicherfunktion	fonction mémoire	funkce paměť	funkcia pamäte
alarm clock function	ébresztőóra funkció	Wecker-Funktion	fonction réveil	funkce budíku	funkcia budíka
built-in speaker	beépített hangszóró	integrierter Lautsprecher	haut-parleur intégré	zabudovaný reproduktor	zabudovaný reproduktor
without pendant set	fűggeszték szett nélkül	ohne Hängeleuchte-Set	Ensemble sans pendentif	Bez závěsného setu	Bez závesného setu
adjustable height shank	állítható magasság	höhenverstellbarer Schaft	avec tige de taille réglable	rameno s nastaviteľnou výškou	rameno s nastaviteľnou výškou
slimline	keskeny kivitel	schmale Variante	version étroite	tenké provedení	úzke prevedenie
works on the principle of magnetic induction	mágneses indukció elvén működik	Funktioniert nach dem Prinzip der magnetischen Induktion	Cela fonctionne sur le principe de l'induction magnétique	Funguje na princípu magnetické indukcie	Funguje na princípe magnetickej indukcie
USB input	USB bemenet	USB-Eingang	Port USB	USB vstup	USB vstup
with USB cable and adaptor	USB vezetékkel és adapterrel	mit USB Kabeln und Adapter	avec câble USB et adaptateur	USB kabel a adaptér	s USB káblom a adaptérom
micro-USB included	micro-USB tartozék	micro-USB Zubehör	Avec Micro USB livré	Micro-USB v príslušenství	Príslušenstvo Micro-USB
can be used as a loudspeaker for smartphone, tablet or computer with the jack cable (included).	hozzáadott Jack kábelletl Okostelefonhoz, táblagéphez, vagy számítógéphez hangfalként használható.	mit beigefügtem Klinckenkabel auch als Lautsprecher für Smartphones, Tablets oder Computer verwendbar	Peut être utilisé comme haut parleur d'un smartphone, d'une tablette ou d'un ordinateur avec le câble jack livré	Funkce reproduktoru prostřednictvím Jack kabelu zapojeného do chytrého telefonu, tabletu nebo počítače	Možnosť použitia ako reproduktor ku chytrému telefónu, tabletu alebo k počítaču s priloženým Jack káblom

KEY OF SYMBOLS • JELMAGYARÁZAT • ZEICHENERKLÄRUNG



POL



UKR



ROM



SRB



CRO

	Oznaczenia	Позначення	Simboluri	Označavanje	Oznake
	metaliczna czerń	металевий чорний	negru metalic	metalik crna	metalno crno
	lśniący	яскравий	lucios	sjajno	sjajno
	miękki w dotyku	м'який дотик	atingere ușoară	mek dodir	lagani dodir
	efekt iskrzenia	мерехтливий ефект	efect strălucitor	efekt svetlucanja	efekt svjetlucanja
	z funkcją timera	з функцією таймера	cu temporizator	sa vremenskom funkcijom	s vremenskom funkcijom
	Funkcja światła nocnego	функція нічника	Funcție lumina de noapte	funkcija nočno svetlo	funkcija noćnog svjetla
	Funkcja pamięci	функція пам'яті	Funcție de memorie	funkcija pamćenja	funkcija memorije
	funkcja budzika	функція будильника	funcție ceas deșteptător	funkcija budilice	funkcija budilice
	wbudowany głośnik	вмонтований гучномовець	Difuzor încorporat	ugrađen zvučnik	ugrađen zvučnik
	Bez zawieszenia	Без підвісного набору	Fără set pandantiv	Bez instaliranog visećeg dela	Set bez privjeska
	ga (podstawa) z możliwością ustawienia wysokości	можливість регулювання по висоті	suport cu înălțime reglabilă	podésiva visina stabla	podésivi krak
	wąska konstrukcja	вузький дизайн	Design îngust	uska izvedba	uska izvedba
	działa na zasadzie indukcji magnetycznej	Він працює за принципом магнітної індукції	Funcționează pe principiul inducției magnetice	radi na principu magnetne indukcije	Radi na principu magnetne indukcije
	port USB	вхід USB	Intrare USB	USB ulaz	USB utor
	z kablem USB i adapterem	із USB-кабелем та адаптером	Cablu USB și adaptor	sa USB priključkom i adapterom	s USB priključkom i adapterom
	Micro-USB w zestawie	Містить мікро-USB	Accesoriu Micro-USB	Mikro-USB dodatna oprema	Mikro USB pribor
	Przy pomocy kabla Jack może być używany jako głośnik do smartfona, tabletu czy komputera	Завдяки доданому кабелю зі штекером можна використовувати до Смартфона, планшета або ПК як гучномовець	Poate fi utilizat ca difuzor cu conexiune cablu Jack la smartphone, tabletă sau calculator	Sa priloženom Jack kablom kao zvučnik može da se priključi pametnom telefonu, tabletu ili računaru	S isporučenim Jack kablom, može se povezati s pametnim telefonom, tabletom ili računalom kao zvučnik

KEY OF SYMBOLS • JELMAGYARÁZAT • ZEICHENERKLÄRUNG



SLO



BUL



LTU



LVA



EST

	Oznake	Символи	Simboliai	Simboli	Sümbolid
	kovinsko črna	метално черно	metalinis juodas	metāliski melns	metalne must
	sijoče	лъскаво	blizgantis	spīdīgs	läikiv
	mehko na dotik	меко докосване	Švelnus palietimas	maiga pieskāriena	pehme puudutus
	učinek bleščanja	искрящ ефект	žvilgesio efektas	spīguļojošs efekts	sādeleva efektīga
	s časovno funkcijo	с функция за време	su laiko funkcija	ar laika funkciju	ajafunktsiooniga
	nočna funkcija	функция нощна светлина	naktinio apšvietimo funkcija	nakts apgaismojuma funkcija	õine funktsioon
	pomnilna funkcija	функция памет	atminties funkcija	atmiņas funkcija	mālu funktsioon
	funkcija budilke	функция на будилника	žadintuvo funkcija	modinātāja funkcija	äratuskella funktsioon
	vgrajen zvočnik	вграден високоговорител	įmontuotas garsiakalbis	iebūvēts skaļrunis	sisseehitatud kõlar
	Brez seta za obešanje	Без комплект за полилей	Be pakabukų rinkinio	Bez piekaramā gaismekļa komplekta	Ilma riputuskomplekta
	nastavljiv nosilec	стълб с променлива височина	reguliuojamo aukščio strypas	regulējams turētāja augstums	reguleeritava kõrgusega kinnitustang
	ozka izvedba	тясно изпълнение	mažų matmenų	plāns	õhuke profiil
	Deluje na principu magnetne indukcije	Работи на принципа на магнитната индукция	Veikia magnetinės indukcijos principu	Darbojas pēc magnētiskās indukcijas principa	Toimib magnetinduktsiooni põhimõttel
	USB vhod	USB вход	USB įvestis	USB ieeja	USB-sisend
	z USB priključkom in adapterjem	с USB кабел и адаптер	su USB kabeliu ir adapteriu	ar USB kabeli un adapteri	USB-kaabli ja adapteriga
	Mikro USB-pripomoček	С принадлежност Micro-USB	Pridedama „Micro-USB“	Micro-USB iekļauts komplektā	Mikro-USB komplektis
	S priloženim Jack kablom se lahko kot zvočnik poveže s pametnim telefonom, tabličnim računalnikom ali računalnikom	С принадлежащия Jack кабел може да се ползва като тонколона към смартфон, таблет или компютър	Galima naudoti kaip išmaniojo telefono, planšetinio kompiuterio arba įprasto kompiuterio garso kolonėlė, prijungus lizdo kabelį (pridedamas)	Var lietot kā skaļruni viedtālrunim, planšētdatoram vai datoram ar līgzdas kabeli (iekļauts komplektā)	Helipistikuga (komplektis) kasutatav nutitelefoni, tahvelarvuti või arvuti kõlarina

KEY OF SYMBOLS • JELMAGYARÁZAT • ZEICHENERKLÄRUNG



GBR



HUN



GER



FRA



CZE

	Symbols	Jelölések	Bezeichnungen	Symboles	Jména
	battery excluded	elemet nem tartalmaz	ohne Batterie	pile non incluse	baterie není součástí balení
	battery included	elemet tartalmaz	inklusive Batterie	pile incluse	součástí balení je baterie
	IK08 strong diffuser	búra mechanikus ütődés elleni védelem 08	Schlagfestigkeit IK08	Diffuseur puissant IK08	Odolnost proti nárazu IK08
	socket light version	konnektorba dugható kivitel	Steckdosenleuchten-Version	Design plug-in	verze světla do zásuvky
	Equipped with SCHUKO Type F, CEE 7/4 power connector socket. Not available for CZ, SK and PL.	SCHUKO Type F, CEE 7/4 hálózati csatlakozó aljzattal. Nem rendelhető: CZ, SK és PL.	Mit SCHUKO Netzstecker Typ F, CEE 7/4. Nicht bestellbar in: CZ, SK und PL.	SCHUKO Type F, avec douille CEE 7/4. Ne peut être commandé : CZ, SK et PL.	SCHUKO Type F, CEE 7/4 se síťovou zásuvkou. Nelze objednat: CZ, SK a PL.
	can be combined with max. ... fixtures	max. ... darabig sorolható	Max. ... Stück in Reihenschaltung verwendbar	alignement jusqu'à ... pièces au maximum	sériové zapojení do max. ... ks
	hand painted	kézzel festett	handbemalt	peint à la main	ručně malované
	paintable	festhető	bemalbar	peut être peint(e)	možnost nabarvení
	with house number sticker	házsám matricával	mit Hausnummersticker	avec sticker numéro de la maison	číslo popisné s nálepkou
	2 in 1	kettő az egyben	2 in 1	2 en 1	2 v 1
	units/set	darab/szett	Stück/Set	pièce/lot	ks/sada
	delivery unit	szállítási egység	Liefereinheit	unité de transport	dodací jednotka
	Cannot be ordered and cannot be delivered to Russia and the Ukraine.	Nem rendelhető és nem szállítható Oroszországba és Ukrajnába.	Nicht bestellbar und lieferbar in Russland und der Ukraine	Ne peut pas être commandé et n'est pas livré en Russie et en Ukraine	Nelze objednat ani dodat do Ruska a na Ukrajinu
	Cannot be ordered and cannot be delivered to Slovakia, Czech Republic, Poland.	Nem rendelhető és nem szállítható Szlovákiába, Csehországba, Lengyelországba.	Kann in der Slowakei, der Tschechischen Republik und in Polen nicht bestellt und nicht geliefert werden.	Ne peut pas être commandé et ne peut pas être livré en Slovaquie, en République tchèque ni en Pologne.	Není možné objednat a nemůže být doručeno na Slovensko, do České republiky, Polska.

KEY OF SYMBOLS • JELMAGYARÁZAT • ZEICHENERKLÄRUNG



SVK



POL



UKR



ROM



SRB

	Označenia	Oznaczenia	Позначення	Simboluri	Označavanje
	batéria nie je súčasťou balenia	Nie zawiera baterii	батарея не додається	bateria nu e inclusă	bez baterije
	súčasťou balenia je batéria	Bateria w zestawie	батарея додається	bateria este inclusă	baterija u opremi
	silný difúzor IK08	Ochrona przed uderzeniami mechanicznymi IK08	Захист від механічного пошкодження плафону IK08	Difuzor puternic IK08	IK08 čvrst difuzor
	verzia svetla do zásuvky	wersja z gniazdem	модель світлового гнізда	versiune cu fasung	verzija sa grlom za lampu
	SCHUKO Type F, CEE 7/4 so sieťovou zásuvkou. Nie je možné objednať: CZ, SK a PL	Z gniazdem zasilania SCHUKO Type F, CEE 7/4. Brak możliwości zamawiania: CZ, SK i PL	SCHUKO Type F, з гніздом живлення CEE 7/4. Неможливо замовляти: CZ, SK та PL	Cu soclu priză SCHUKO Type F, CEE 7/4. Nu poate fi comandat în CZ, SK și PL	Sa mrežnom priključnicom tipa SCHUKO Type F, CEE 7/4. Ne može da se naruči iz: CZ, SK i PL
	možnosť zapojenia do radu do max ... ks	podłączenie szeregowo maks. ... szt	можливо послідовно з'єднати макс. до ... шт.	serie de maxim ... bucăți	maksimalno do ... kom. može da se priključi redno
	ručne malované	ręcznie malowane	фарбований вручну	vopsit manual	ručno farbana
	možnosť maľovania	przystosowana do malowania	можна фарбувати	Poate fi vopsit	može da se farba
	s nálepkou čísla domu	z naklejką numeru domu	із наклейкою номера будинку	număr de casă cu sticker	sa matricom kućnog broja
	2 v 1	2 w 1	2 в 1	2 în 1	2 u 1
	kus/sada	sztuka/zestaw	шт/комплект	bucăți/set	komad/set
	dodacia jednotka	jednostka logistyczna	одиниця поставки	unitate de livrare	transportna jedinica
	Nie je možné objednať a nedodáva sa do Ruska a Ukrajinu	Brak możliwości zamawiania i dostawy do Rosji i na Ukrainę	Можливість замовлення і доставки до Росії та України відсутня	Nu poate fi comandat din și livrat în Rusia și Ucraina	Ne može da se naruči i da se isporuči u Rusiju i u Ukrajinu
	Nie je možné objednať a nemôže byť doručené na Slovensko, do Českej republiky, Polska.	Niedostępne dla zamówienia i dostawy na Słowację, do Czech i Polski.	Неможливо замовити та неможливо доставити до Словаччини, Чехії, Польщі.	Nu poate fi comandat din și nici livrat în Slovacia, Republica Cehă, Polonia.	Ne može da se naruči i ne može da se isporuči u Slovačku, Češku Republiku i Poljsku.

KEY OF SYMBOLS • JELMAGYARÁZAT • ZEICHENERKLÄRUNG



CRO



SLO



BUL



LTU



LVA



EST

	Oznake	Oznake	Символи	Simboliai	Simboli	Sümbolid
	baterija nije uključena	baterije niso uključene	не е предоставена батерия	be baterijos	baterija neietilpst komplektā	patarei ei kuulu komplekti
	baterija je uključena	baterije so uključene	предоставена батерия	su baterija	baterija ietilpst komplektā	patarei kuulub komplekti
	zaštita od mehaničkih utjecaja	IK08 močan difuzor	Устойчивост на удар IK08	Tvirtumo klasė IK08	IK08 spēcīgs difuzors	IK08 lőögikindluse klassi hajuti
	verzija s grlom za svjetiljku	različica z okovom žarnice	тип на цокъла	kontaktligzdā iespraužamu gaismekļu versija	lizdo lempos versija	lambipesaga versioon
	S mrežnim priključkom tipa SCHUKO Type F, CEE 7/4 Nije moguće naručiti iz: CZ, SK i PL	Z vtičem tipa SCHUKO Type F, CEE 7/4 Ni mogoče naročiti pri: CZ, SK in PL	SCHUKO Type F, захранващо щепселно гнездо CEE 7/4. Не може да се заявява за: CZ, SK и PL	Įmontuotas SCHUKO F tipo CEE 7/4 maitinimo įvesties lizdas. Neprieinama CZ, SK ir PL	Aprīkots ar SCHUKO F tipa, CEE 7/4 strāvas ievades/izvades ligzdu. Nav pieejams CZ, SK un PL	SCHUKO Tüüp F, CEE 7/4 toite sisse/välja pistikuga. Mitte saadaval CZ, SK ja PL jaoks
	maksimalno do ... kom. mogu se redovito povezivati	največ do ... kos. se lahko redno poveže	може да ползва макс. ... бр.	galima prijungti maks. ... tvirtinimo elementus	var apvienot ar maks. ... gaismekļiem	kombineeritav kuni ... valgustiga
	ručno farbana	ročno barvana	оцветен на ръка	ranka dažytas	apgleznots ar rokām	käsitsi värvitud
	može da se farba	lahko naslikamo	оцветим	galima nudažyti	var krāsot	värvitav
	s matricom kućnog broja	z matrico hišnega številk	със стикер дом№	su namo numerio lipduku	ar ēkas numura uzlīmi	koos majanumbri kleepsuga
	2 u 1	2 v 1	2 в 1	Du viename	Divi vienā	Kaks-ühes
	komad/set	kos/set	брой/сет	vnt./rinkinys	gab./komplektā	tükki/komplekt
	transportna jedinica	transportna enota	транспортна единица	pristatomas įrenginys	piegādes vienība	tarnesse kuulub
	Ne može se naručiti i isporučiti u Rusiju i u Ukrajinu	Ni ga mogoče naročiti in dostaviti v Rusijo in Ukrajinu	Не може да се заявява и не се доставя в Русия и Украйна	Negalima užsakyti ir pristatyti į Rusiją ir į Ukrainą	Nevar pasūtīt un piegādāt uz Krieviju un Ukrainu	Venemaale ja Ukrainasse ei saa tellida ega saata
	Ne može se naručiti niti isporučiti u Slovačku, Republiku Češku i Poljsku.	Ni mogoče naročiti iz in ne more biti dostavljeno na Slovaško, Češko in Poljsko.	Не може да бъде поръчано и не може да бъде доставено до Словакия, Чехия, Полша.	Negalima užsakyti ir pristatyti į Slovakiją, Čekiją, Lenkiją.	Nevar pasūtīt un piegādāt uz Slovākiju, Čehiju un Poliju.	Ei saa tellida ja tarnida Slovakkiasse, Tšehhi Vabariiki ja Poolasse.

IMPRINT • IMPRESSZUM • IMPRESSUM

English

Colour and pattern discrepancy are possible. We are entitled to change the pattern. We don't bear the responsibility of the printing failure.

Magyar

Szín és minta eltérés lehetséges. A minta változtatás jogát fenntartjuk! Az esetleges nyomdai hibákért elnézésüket kérjük és azokért felelősséget nem vállalunk.

Deutsch

Farbe und Musterunterschied ist möglich. Wir halten das Recht von Musteränderung aufrecht. Vor die eventuellen Druckfehler bitten wir um Entschuldigung und vor die Fehler können wir die Verantwortung nicht übernehmen.

Français

Il est bien possible d'avoir quelques alternances de la coloration et du modele. Nous soutenons notre droit aux changements de modeles. Excusez-nous des eventuelles fautes d'imprimerie dont nous ne nous considerons pas etre les responsables.

Česky

Prodejce si vyhrazuje právo průběžně modifikovat své výrobky a tedy údaje uvedené v tomto katalogu mohou být bez předchozího oznámení změněny. Tiskové chyby vyhrazeny.

Slovensko

Obstaja možnost odstopanja pri odtenku barve izdelka. Pridržujemo si pravico do spremembe vzorca. Ne prevzemamo odgovornosti za morebitne tiskarske napake.

Polski

Możliwe są odchylenia w kolorach i wzorach. Podtrzymujemy prawo zachowania zmiany wzoru. Przeprasamy, a zarazem nie ponosimy odpowiedzialności za ewentualne błędy powstałe w druku.

Українська

Можлив зміни у кольорах та зображеннях. Ми можемо змінити зразок. Не несемо відповідальності за можливі друкарські помилки. Просимо вибачення та в подальшому не несемо.

Română

Este posibilă alternanța model/culoare. Ne reținem dreptul de a schimba modelele. Pentru eventualele greseli de tipar, Va cerem scuze ;dar nu ne asumăm răspunderea pentru ele.

Srpski

Moguće su razlike u bojama i šarama. Zadržavamo pravo na promene šara. Za moguće štamparske greške unapred se izvinjavamo i za njih ne primamo na sebe odgovornost.

Hrvatski

Postoji mogućnost odstupanja u nijansi boje artikla. Ne snosimo odgovornost u slučaju pogreške u tisku.

Slovensky

Predávajúci si vyhradzuje právo priebežne modifikovať svoje výrobky a preto aj údaje uvedené v tomto katalogu, môžu byť zmenené bez predchádzajúceho oznámenia. Za prípadné tlačové chyby nenesieme zodpovednosť.

Български

Възможни са промени в цветовете и нюансите. Ние не носим отговорност за печатни грешки.

Lietuvių

Galimi spalvų ir rašto netikslumai. Pasiliegame teisę keisti raštą. Atsiprašome, bet už spausdinimo klaidas neprisiimame atsakomybės.

Latviešu

Ir iespējamas krāsas un modeļa neatbilstības. Mēs paturam tiesības mainīt modeli. Atvainojamies, tomēr neuzņemamies atbildību par drukas kļūdām.

Eesti

Värv ja muster võib erineda. Jätame endale õiguse muutmiseks. Vabandame, kuid ei vastuta trükkivigade eest.

Grafikai munkák: Visionext Reklámstúdió
Nyomdai munkák: Keskeny és Társai 2001 Kft.

CONTENTS • TARTALOMJEGYZÉK • INHALTSVERZEICHNIS

New	Art. number	Name	Page	New	Art. number	Name	Page	New	Art. number	Name	Page	New	Art. number	Name	Page
Új	Cikkszám	Név	Oldal	Új	Cikkszám	Név	Oldal	Új	Cikkszám	Név	Oldal	Új	Cikkszám	Név	Oldal
Neu	Art. nummer	Name	Seite	Neu	Art. nummer	Name	Seite	Neu	Art. nummer	Name	Seite	Neu	Art. nummer	Name	Seite
NEW	559	Remote control	332		1470	Lina	514	NEW	2065	Matt	553		2235	Anna	182
	1046	Lite	588		1477	Noah	497	NEW	2066	Matt	553	NEW	2236	Pallas	36
	1047	Lite	588		1478	Noah	497		2094	Carly	124	NEW	2237	Pallas	36
	1048	Lite	588		1479	Noah	497	NEW	2095	Carly	124	NEW	2238	Pallas	36
	1049	Lite	589		1480	Noah	497	NEW	2096	Carly	124	NEW	2239	Pallas	36
	1050	Lite	589		1481	Noah	497		2102	Lanny	126		2269	Joel	222
	1051	Lite	589		1482	Noah	497		2103	Lanny	126		2270	Joel	222
	1072	Randy	592		1489	Sonnet	575		2104	Lanny	126		2271	Joel	222
	1078	Randy	592		1490	Sonnet	575		2110	Becca	537		2276	Manorca	141
	1079	Randy	592		1491	Sonnet	575		2111	Becca	537		2277	Manorca	141
	1080	Randy	592		1492	Sonnet	575		2112	Becca	537		2278	Kaia	138
	1087	Spot relight	590		1496	Ludovic	569		2113	Becca	537		2279	Kaia	138
	1088	Spot relight	590		1498	Ludovic	569		2114	Levon	554		2284	Rob	400
	1089	Spot relight	590		1507	Mason	380		2115	Levon	554		2285	Rob	400
	1090	Spot relight	590		1508	Mason	380		2116	Lanny	126		2286	Rob	401
	1091	Spot relight	591		1509	Mason	380	NEW	2117	Bruce	376		2287	Rob	401
	1092	Spot relight	591		1510	Leonie	373	NEW	2118	Bruce	376		2298	Taylor	373
	1093	Spot relight	591		1511	Leonie	373	NEW	2119	Sedona	355		2301	Band light	566
	1095	Spot relight	591	NEW	1513	Smart wifi bulb	332	NEW	2120	Lupita	350		2302	Band light	566
	1116	Spot fashion	593		1515	Justin	491	NEW	2131	Lupita	350		2303	Band light	566
	1117	Spot fashion	593		1518	Coralia	370	NEW	2156	Alessandra	185		2304	Band light	566
	1120	Spot fashion	593		1519	Coralia	370		2157	Alessandra	185		2305	Band light	566
	1147	Spot fashion	593		1800	Iris	426		2158	Alessandra	185		2306	Band light	567
	1148	Spot fashion	593		1803	Simple	428		2158	Alessandra	185		2306	Band light	567
	1160	Spot fashion	593		1803	Simple	428		2161	Alessandra	184		2307	Band light	567
	1163	Lite	588		1814	Soley	429		2162	Alessandra	184		2308	Band light	567
	1166	Lite	589		1815	Soley	429		2163	Alessandra	184		2309	Band light	567
	1301	Bottom	443		1817	Soley	429	NEW	2166	Evan	529		2321	Bath	564
	1302	Togo	546		1818	Soley	429	NEW	2167	Evan	529		2322	Bath	564
	1331	Fix	442		1819	Soley	429	NEW	2168	Evan	529		2323	Bath	564
	1332	Fix	442		1822	Spiral	428		2173	Damek	402		2326	Soft	565
	1338	Fix	442		1843	Ada	426		2174	Damek	402		2327	Soft	565
	1407	Cupola range	438		1844	Ada	426		2175	Damek	402		2328	Soft	565
	1408	Cupola range	438		1845	Scroll	426		2183	Selena	46		2329	Soft	565
	1411	Fixy	440		1846	Scroll	426		2184	Selena	46		2341	Slim	561
	1412	Roxy	441		1847	Bloomy	427		2185	Azra	47		2342	Slim	561
	1414	Roxy	441		1848	Bloomy	427		2186	Azra	47		2343	Slim	561
	1415	Roxy	441		1861	Jolly	422		2187	Aniela	45		2344	Slim	561
	1417	Fixy	440		1862	Jolly	422		2188	Aniela	45		2345	Slim	561
	1418	Fixy	440		1864	Jolly	422		2189	Melora	44		2361	Easy light	559
	1421	Rolly pull	443		1896	Iris	426		2190	Melora	44		2362	Easy light	559
	1426	Primrose	372		1940	Art gold	415		2191	Taleb	403		2363	Easy light	559
	1427	Primrose	372		1941	Art gold	415		2192	Taleb	403		2364	Easy light	559
	1428	Nolan	376		1942	Art gold	415		2193	Taleb	403		2365	Easy light	559
	1431	Marlon	169		1955	Art flower	224	NEW	2194	Niagara	534		2366	Easy light	559
	1433	Marlon	169		1956	Art flower	224	NEW	2195	Niagara	534		2388	Streak light	563
	1435	Marlon	169		1960	Jolly	422		2202	Vera	61		2389	Streak light	563
	1439	Neville	171	NEW	1978	Smart wifi bulb	333		2203	Vera	61		2390	Streak light	563
	1440	Neville	171	NEW	1979	Smart wifi bulb	333		2204	Vera	61	NEW	2420	Cressida	371
	1444	Byron	557	NEW	1980	Smart wifi bulb	333		2215	Berbera	82	NEW	2427	Tamino	407
	1445	Byron	557	NEW	2012	Lagertha	355		2216	Berbera	82		2428	Adrienne	49
	1448	Albina	554	NEW	2047	Kobald	572		2220	Ulla	57		2429	Adrienne	49
	1449	Albina	554	NEW	2048	Kobald	572		2224	Caspar	118		2431	Grace	437
	1450	Batten light	560	NEW	2049	Kobald	572		2225	Adon	380		2432	Grace	437
	1451	Batten light	560	NEW	2050	Kobald	572	NEW	2229	Avalon	39		2433	Alyson	47
	1452	Batten light	560	NEW	2051	Kobald	573	NEW	2229	Avalon	369		2448	Danielle	181
	1453	Batten light	560	NEW	2052	Kobald	573	NEW	2230	Avalon	39		2449	Danielle	181
	1454	Drop light	695	NEW	2053	Kobald	573	NEW	2230	Avalon	369		2451	Marcella	181
	1455	Drop light	695	NEW	2054	Kobald	573		2232	Anna	182		2478	Meredith	56
	1464	Albina	554	NEW	2055	Kobald	573		2233	Anna	182		2479	Meredith	56
				NEW	2056	Kobald	573		2234	Anna	182		2480	Meredith	57

CONTENTS • TARTALOMJEGYZÉK • INHALTSVERZEICHNIS

New	Art. number	Name	Page	New	Art. number	Name	Page	New	Art. number	Name	Page	New	Art. number	Name	Page
Új	Cikkszám	Név	Oldal	Új	Cikkszám	Név	Oldal	Új	Cikkszám	Név	Oldal	Új	Cikkszám	Név	Oldal
Neu	Art. nummer	Name	Seite	Neu	Art. nummer	Name	Seite	Neu	Art. nummer	Name	Seite	Neu	Art. nummer	Name	Seite
	2481	Meredith	56		2666	Lois	587		3002	Alabastro	420	NEW	3126	Dimitri	103
	2484	Donald	574		2667	Lois	587		3003	Alabastro	421	NEW	3127	Grendel	98
	2485	Donald	574		2668	Lois	587		3008	Trevor	399	NEW	3127	Grendel	272
	2486	Maddox	574		2669	Lois	587		3009	Trevor	399	NEW	3128	Grendel	98
	2487	Maddox	574		2670	Lois	587		3010	Trevor	399	NEW	3128	Grendel	272
	2496	Loki	694		2676	Flores	523		3015	Calvin	375	NEW	3129	Grendel	98
	2497	Loki	694		2677	Hekla	525		3016	Kinga	462	NEW	3129	Grendel	272
	2503	Alexis	55		2694	Nalani	463		3017	Kinga	462	NEW	3130	Grendel	98
	2504	Alexis	55		2695	Nalani	463		3018	Callia	60	NEW	3130	Grendel	272
	2507	Adeline	66		2696	Nalani	463		3019	Callia	60	NEW	3131	Grendel	99
	2507	Adeline	386		2697	Zenon	545		3020	Callia	60	NEW	3131	Grendel	273
	2508	Adeline	66		2698	Zenon	545		3050	Alfons	326	NEW	3132	Grendel	99
	2508	Adeline	386		2699	Zenon	545		3053	Alabastro	419	NEW	3132	Grendel	273
	2509	Adeline	66		2700	Zenon	545		3054	Slava	541	NEW	3133	Rattan	112
	2510	Adeline	66		2701	Marian	212		3059	Calista	146	NEW	3133	Rattan	262
	2543	Donatella	48		2702	Marian	212		3060	Calista	146	NEW	3134	Rattan	112
	2544	Donatella	48		2703	Marian	212		3064	Ziva	371	NEW	3134	Rattan	262
	2545	Donatella	48		2705	Marian	213		3072	Lucas	396	NEW	3135	Rattan	112
	2546	Donatella	48		2706	Marian	212		3073	Lucas	396	NEW	3135	Rattan	262
	2558	Holden	414		2707	Marian	212		3074	Lucas	396	NEW	3136	Rattan	112
	2559	Shane	140		2708	Marian	213		3075	Benita	394	NEW	3136	Rattan	262
	2560	Shane	140		2713	Elsa	248		3076	Benita	394</				

CONTENTS • TARTALOMJEGYZÉK • INHALTSVERZEICHNIS

New	Art. number	Name	Page
Új	Cikkszám	Név	Oldal
Neu	Art. nummer	Name	Seite

NEW	3185	Blake	287
NEW	3186	Blake	287
	3201	Alabastro	420
	3202	Alabastro	420
	3203	Alabastro	421
NEW	3207	Antoine	535
NEW	3208	Antoine	535
NEW	3209	Antoine	535
NEW	3210	Antoine	535
NEW	3214	Fidel	120
NEW	3214	Fidel	268
NEW	3215	Fidel	120
NEW	3215	Fidel	268
NEW	3216	Fidel	120
NEW	3216	Fidel	268
NEW	3217	Fidel	120
NEW	3217	Fidel	268
NEW	3218	Fidel	121
NEW	3218	Fidel	269
NEW	3219	Rufin	123
NEW	3219	Rufin	481
NEW	3220	Rufin	123
NEW	3220	Rufin	481
	3234	Andra	395
	3235	Andra	395
	3236	Andra	395
	3237	Andra	395
	3238	Andra	395
NEW	3239	Ophus	451
NEW	3240	Ophus	451
NEW	3244	Miguel	79
NEW	3244	Miguel	294
NEW	3245	Miguel	79
NEW	3245	Miguel	294
NEW	3246	Miguel	79
NEW	3246	Miguel	294
NEW	3247	Miguel	79
NEW	3247	Miguel	294
NEW	3248	Tarien	239
NEW	3249	Tarien	239
NEW	3250	Tarien	239
	3253	Alabastro	419
NEW	3254	Tornado	350
	3256	Meridia	43
	3257	Meridia	43
NEW	3260	Octav	392
	3264	Taneli	352
	3278	Pavel	405
	3283	Foster	382
NEW	3295	Sullivan	20
NEW	3296	Sullivan	20
NEW	3297	Sullivan	20
NEW	3298	Rotem	155
NEW	3298	Rotem	274
NEW	3299	Rotem	155
NEW	3299	Rotem	274
NEW	3300	Rotem	155
NEW	3300	Rotem	274
	3301	Alabastro	420
	3302	Alabastro	420

New	Art. number	Name	Page
Új	Cikkszám	Név	Oldal
Neu	Art. nummer	Name	Seite

	3303	Alabastro	421
	3307	Otilia	75
	3308	Otilia	75
NEW	3309	Yago	548
NEW	3309	Yago	683
NEW	3310	Yago	548
NEW	3310	Yago	683
NEW	3314	Tesia	384
NEW	3315	Tesia	384
NEW	3316	Tesia	385
NEW	3317	Tesia	385
	3318	Portia	357
	3319	Portia	357
	3320	Zenith	362
	3324	Thalassa	359
	3328	Tayla	374
	3331	Vesta	363
	3335	Aquila	363
	3338	Rob	401
	3339	Rob	401
	3340	Rob	401
	3344	Rob	401
	3345	Oscar	391
	3346	Oscar	391
	3347	Oscar	391
	3348	Oscar	391
	3349	Misha	490
	3350	Misha	490
	3353	Alabastro	419
	3358	Lambert	543
	3359	Lambert	543
	3409	Oscar	390
	3410	Oscar	390
	3411	Oscar	390
	3416	Hanka	508
	3417	Hanka	508
	3418	Lucas	398
	3418	Lucas	693
	3419	Lucas	398
	3419	Lucas	693
	3420	Lucas	398
	3420	Lucas	693
	3427	Pavel	405
	3428	Pavel	405
	3429	Pavel	405
	3430	Pavel	405
	3434	Lucas	398
	3435	Lucas	398
	3437	Lucas	397
	3437	Lucas	544
	3438	Lucas	397
	3438	Lucas	544
	3439	Lucas	397
	3439	Lucas	544
	3440	Galeti	372
NEW	3449	Bellamy	368
NEW	3464	Balthasar	540
	3468	Aslan	147
	3469	Aslan	147
	3470	Aslan	147

New	Art. number	Name	Page
Új	Cikkszám	Név	Oldal
Neu	Art. nummer	Name	Seite

NEW	3478	Linden	377
NEW	3479	Linden	377
NEW	3480	Jakub	552
	3481	Tom	417
	3482	Arcadia	361
	3483	Tom	417
	3484	Tom	417
	3487	Lorna	404
	3488	Lorna	404
	3489	Lorna	404
	3490	Lorna	404
NEW	3500	Sherwood	408
NEW	3508	Glory	18
NEW	3509	Rodion	342
NEW	3510	Everest	340
	3513	Svetlana	54
	3514	Svetlana	54
	3515	Svetlana	54
	3516	Lionel	488
	3517	Lionel	488
	3518	Nesrin	151
	3519	Nesrin	151
	3520	Nesrin	151
NEW	3527	Maple	409
NEW	3528	Maple	409
	3529	Saphira	362
	3530	Saphira	362
	3534	Belano	100
	3535	Belano	100
	3536	Belano	100
	3536	Lucas	398
	3537	Belano	100
	3538	Belano	100
	3539	Belano	101
	3540	Belano	101
	3542	Zenaida	23
	3543	Zenaida	23
	3543	Zenaida	23
	3545	Zenaida	23
	3547	Fedora	257
	3548	Fedora	257
	3549	Fedora	257
	3550	Fedora	257
	3563	Disky	433
	3564	Disky	433
	3567	Disky	433
	3568	Disky	433
	3569	Rosanna	180
	3570	Rosanna	180
NEW	3579	Miroslaw	17
NEW	3580	Miroslaw	17
	3598	Ninelle	37
	3599	Ninelle	37
	3607	Harlow	93
	3640	Picture guard	568
	3641	Picture light	568
	3642	Picture light	568
	3643	Picture light	568
	3644	Picture light	568
	3650	Picture guard	568

New	Art. number	Name	Page
Új	Cikkszám	Név	Oldal
Neu	Art. nummer	Name	Seite

NEW	3680	Wasabi	522
	3687	Nedda	432
	3688	Nedda	432
	3689	Nedda	432
	3691	Elina	423
	3692	Elina	423
	3693	Elina	423
	3694	Elina	423
NEW	3696	Wasabi	522
	3697	Phaedra	431
	3698	Phaedra	431
	3699	Phaedra	431
	3712	Laretta	416
	3713	Laretta	416
	3714	Laretta	416
	3721	Athen	193
	3722	Athen	193
	3723	Athen	193
	3750	Valter	361
	3837	Charles	432
	3838	Charles	432
	3839	Charles	432
	3850	Harmony lux	425
	3851	Harmony lux	424
	3852	Harmony lux	424
	3853	Harmony lux	424
	3854	Harmony lux	425
	3855	Harmony lux	425
	3856	Harmony lux	425
	3859	Aldona	75
	3860	Aldona	75
	3874	Toma	541
	3875	Toma	541
	3887	Scottie	430
	3888	Scottie	430
	3889	Scottie	430
	3904	Alabastro	421
	3905	Alabastro	421
	3907	Picture slim	569
	3908	Picture slim	569
	3909	Picture slim	569
	3910	Picture slim	569
	3916	Sorina	204
	3917	Sorina	204
	3918	Sorina	204
	3926	Adeline	67
	3926	Adeline	386
	3927	Adeline	67
	3928	Adeline	67
	3928	Adeline	386
	3929	Adeline	67
	3934	Igor	379
	3935	Igor	379
	3936	Lucas	397
	3937	Lucas	397
	3938	Lucas	397
	3954	Alabastro	419
	3955	Alabastro	419
	3958	Balor	494
	3959	Balor	494

CONTENTS • TARTALOMJEGYZÉK • INHALTSVERZEICHNIS

New	Art. number	Name	Page
Új	Cikkszám	Név	Oldal
Neu	Art. nummer	Name	Seite

	3966	Soraya	298
	3967	Soraya	298
	3968	Soraya	298
	3969	Soraya	299
	3970	Soraya	299
NEW	3976	Pablo	116
NEW	3976	Pablo	264
NEW	3977	Pablo	116
NEW	3977	Pablo	264
NEW	3978	Pablo	116
NEW	3978	Pablo	264
NEW	3979	Pablo	116
NEW	3979	Pablo	264
NEW	3980	Pablo	117
NEW	3980	Pablo	265
NEW	3986	Lamar	119
NEW	3986	Lamar	267
NEW	3987	Lamar	119
NEW	3987	Lamar	267
NEW	3988	Lamar	119
NEW	3988	Lamar	267
NEW	3989	Lamar	119
NEW	3989	Lamar	267
NEW	3990	Lamar	119
NEW	3990	Lamar	267
	3998	Avery	546
	3999	Avery	546
	4000	Dafina	389
	4009	Art flower	224
	4009	Art flower	454
	4019	Pearl classic	455
	4020	Action	457
	4026	Action	456
	4028	Action	456
	4037	Bank	482
	4038	Bank	482
	4059	Diana	455
	4060	Action	456
	4061	Action	456
	4062	Action	457
	4064	Action	457
	4065	Action	457
	4067	Diana	455
	4068	Diana	455
	4075	Beta	452
	4076	Beta	452
	4077	Gamma	453
	4078	Gamma	453
	4091	Harmony	454
	4093	Ozone	525
	4096	Vesuvius	525
	4097	Fuji	523
	4106	Lollipop 2	519
	4108	Lollipop 2	519
	4109	Marshal	518
	4110	Marshal	518
	4111	Dovce	519
	4112	Dovce	519
	4113	Glitter	521
	4114	Glitter	521

New	Art. number	Name	Page
Új	Cikkszám	Név	Oldal
Neu	Art. nummer	Name	Seite

	4115	Glitter	521
	4120	Rock	524
	4127	Rock	524
	4129	Rock	524
	4130	Rock	524
	4159	Leslie	450
	4162	Aaron	450
	4164	Dominic	492
	4167	Dominic	492
	4168	Dylan	487
	4169	Dylan	487
	4170	Dylan	487
	4171	Dylan	487
	4172	Dylan	487
	4178	Samson	483
	4179	Samson	483
	4188	Action	457
	4192	Thomas	461
	4195	Jeff	496
	4196	Jeff	496
	4197	Jeff	496
	4198	Jeff	496
	4199	Aksel	159

CONTENTS • TARTALOMJEGYZÉK • INHALTSVERZEICHNIS

New	Art. number	Name	Page
Új	Cikkszám	Név	Oldal
Neu	Art. nummer	Name	Seite

New	Art. number	Name	Page
Új	Cikkszám	Név	Oldal
Neu	Art. nummer	Name	Seite

New	Art. number	Name	Page
Új	Cikkszám	Név	Oldal
Neu	Art. nummer	Name	Seite

New	Art. number	Name	Page
Új	Cikkszám	Név	Oldal
Neu	Art. nummer	Name	Seite

	5060	Morris	439
	5062	Evron	553
	5063	Evron	553
	5064	Evron	553
NEW	5066	Oswald	393
NEW	5069	Zircon	88
NEW	5069	Zircon	284
NEW	5070	Zircon	88
NEW	5070	Zircon	284
NEW	5071	Zircon	89
NEW	5071	Zircon	285
NEW	5072	Zircon	88
NEW	5072	Zircon	284
NEW	5073	Zircon	89
NEW	5073	Zircon	285
NEW	5074	Zircon	89
NEW	5074	Zircon	285
NEW	5075	Zircon	89
NEW	5075	Zircon	285
NEW	5076	Zircon	89
NEW	5076	Zircon	285
	5077	Mirosław	128
	5078	Mirosław	128
NEW	5081	Renata	72
NEW	5082	Renata	72
NEW	5083	Renata	72
NEW	5084	Renata	72
	5085	Norena	139
	5086	Norena	139
	5087	Aviva	532
	5088	Aviva	532
	5089	Alberta	148
	5090	Alberta	148
	5091	Alberta	148
	5092	Alberta	148
	5093	Aneta	80
	5094	Aneta	80
	5095	Aneta	80
	5096	Aneta	81
	5097	Aneta	81
	5098	Fauna	207
	5099	Fauna	207
	5101	Ufo	437
	5103	Ufo	436
	5113	Ufo	435
	5121	Ufo	435
	5131	Ufo	437
	5143	Ufo	435
	5151	Ufo	435
	5161	Ufo	437
	5163	Ufo	436
	5173	Ufo	435
	5181	Ufo	435
	5196	Jasna	389
	5203	Ufo	436
	5207	Jeremy	542
	5208	Jeremy	542
	5209	Jeremy	542
	5210	Jeremy	542
	5216	Greg	562

	5217	Greg	562
	5218	Greg	562
	5219	Greg	562
NEW	5220	Wendy	464
NEW	5221	Wendy	464
	5222	Donati	22
	5223	Donati	22
	5224	Sinopia	174
	5225	Sinopia	174
	5226	Azurine	24
	5227	Azurine	24
	5228	Sheila	25
	5229	Sheila	25
NEW	5230	Celinda	357
	5233	Ufo	436
NEW	5237	Rupert	97
NEW	5238	Rupert	97
NEW	5239	Daron	137
NEW	5239	Daron	447
NEW	5240	Daron	137
NEW	5240	Daron	447
NEW	5241	Daron	137
NEW	5241	Daron	447
NEW	5242	Egon	327
NEW	5243	Egon	327
NEW	5244	Fabian	114
NEW	5245	Fabian	114
NEW	5245	Fabian	458
NEW	5246	Fabian	115
NEW	5246	Fabian	458
NEW	5247	Fabian	115
NEW	5248	Donati	14
NEW	5249	Donati	14
NEW	5250	Donati	14
NEW	5251	Donati	15
NEW	5252	Petunia	18
NEW	5253	Petunia	18
NEW	5254	Ronnie	477
NEW	5255	Ronnie	477
	5263	Ufo	436
NEW	5277	Nicolas	156
NEW	5278	Nicolas	156
NEW	5278	Nicolas	480
NEW	5279	Nicolas	156
NEW	5281	Indiana	110
NEW	5282	Indiana	110
NEW	5283	Indiana	111
NEW	5284	Indiana	110
NEW	5285	Sirius	366
NEW	5286	Sirius	366
NEW	5287	Sirius	366
NEW	5288	Sirius	366
NEW	5289	Sirius	367
NEW	5290	Sirius	367
NEW	5293	Kamala	107
NEW	5295	Edmund	157
NEW	5295	Edmund	275
NEW	5296	Edmund	157
NEW	5296	Edmund	275
NEW	5297	Edmund	157

NEW	5297	Edmund	275
NEW	5298	Edmund	157
NEW	5298	Edmund	275
	5299	Hestia	198
	5299	Hestia	300
	5300	Hestia	198
	5300	Hestia	300
	5301	Hestia	199
	5301	Hestia	301
	5302	Hestia	199
	5302	Hestia	301
	5303	Hestia	198
	5303	Hestia	300
	5304	Hestia	199
	5304	Hestia	301
	5305	Hestia	198
	5305	Hestia	300
NEW	5307	Dragan	130
NEW	5308	Dragan	130
NEW	5309	Dragan	131
NEW	5310	Dragan	131
NEW	5310	Dragan	449
NEW	5311	Trincola	134
NEW	5312	Trincola	134
	5322	Konrad	162
	5322	Konrad	282
	5323	Konrad	162
	5323	Konrad	282
	5324	Konrad	162
	5324	Konrad	282
	5325	Konrad	162
	5325	Konrad	282
	5332	Jarina	200
	5333	Jarina	200
	5334	Jarina	200
	5335	Oberon	104
	5336	Oberon	104
	5337	Oberon	104
	5338	Oberon	104
	5339	Oberon	105
	5340	Oberon	105
	5341	Lacey	296
	5342	Lacey	296
	5343	Lacey	297
	5344	Lacey	296
	5345	Lacey	297
	5346	Tamara	241
	5347	Tamara	241
	5348	Tamara	241
	5349	Tamara	241
	5351	Divina	31
	5352	Divina	31
	5353	Divina	31
	5354	Konrad	163
	5354	Konrad	251
	5355	Konrad	163
	5355	Konrad	251
	5356	Konrad	163
	5356	Konrad	251
	5357	Konrad	163

	5357	Konrad	251
NEW	5359	Cortado	92
NEW	5360	Cortado	93
NEW	5361	Cortado	92
NEW	5364	Ophelia	340
NEW	5365	Ophelia	340
	5367	Oleg	577
	5368	Oleg	577
	5369	Oleg	577
	5370	Oleg	577
	5371	Oleg	576
	5372	Oleg	576
	5373	Oleg	576
	5374	Oleg	576
	5379	Basil	290
	5380	Basil	290
	5381	Basil	290
	5382	Basil	290
	5383	Basil	291
	5384	Basil	291
	5384	Basil	460
	5385	Basil	291
	5385	Basil	460
	5386	Thelma	288
	5387	Thelma	288
	5388	Thelma	288
	5389	Thelma	288
	5394	Kassia	177
	5395	Kassia	177
	5396	Kassia	177
	5397	Salazar	240
	5398	Salazar	240
	5399	Salazar	240
	5400	Salazar	240
	5401	Ufo	434
	5407	Ufo	434
	5409	Baloo	513
	5410	Baloo	513
	5411	Ufo	434
	5417	Ufo	434
NEW	5419	Adonias	346
NEW	5420	Benicio	347
	5421	Ufo	434
	5427	Ufo	434
	5429	Timothy	493
	5430	Timothy	493
	5435	Rob	400
	5436	Rob	400
	5437	Francis	202
	5437	Francis	317
	5438	Francis	202
	5438	Francis	317
	5439	Francis	202
	5439	Francis	317
	5440	Francis	202
	5440	Francis	317
	5445	Danny	378
	5446	Danny	378
	5447	Danny	378
	5448	Danny	378

CONTENTS • TARTALOMJEGYZÉK • INHALTSVERZEICHNIS

New	Art. number	Name	Page
Új	Cikkszám	Név	Oldal
Neu	Art. nummer	Name	Seite

New	Art. number	Name	Page
Új	Cikkszám	Név	Oldal
Neu	Art. nummer	Name	Seite

New	Art. number	Name	Page
Új	Cikkszám	Név	Oldal
Neu	Art. nummer	Name	Seite

New	Art. number	Name	Page
Új	Cikkszám	Név	Oldal
Neu	Art. nummer	Name	Seite

	5449	Danny	378
	5450	Danny	378
	5459	Petrina	201
	5460	Petrina	201
	5469	Anais	53
	5470	Anais	53
	5489	Tony	538
	5490	Tony	538
	5491	Tony	538
	5492	Tony	538
	5497	Steve	531
	5498	Steve	531
	5499	Steve	531
	5500	Steve	531
	5509	Galen	465
	5510	Galen	465
	5532	Jenna	308
	5533	Jenna	308
	5534	Jenna	308
	5539	Gavin	167
	5539	Gavin	260
	5540	Damien	342
	5546	Holly	242
	5547	Holly	242
	5548	Holly	242
	5549	Holly	242
	5550	Holly	242
	5551	Holly	243
	5552	Holly	242
	5553	Holly	243
	5555	Holly	244
	5556	Holly	244
	5557	Holly	245
	5558	Holly	244
	5559	Holly	244
	5560	Holly	245
	5561	Holly	245
	5562	Holly	245
	5564	Karen	166
	5564	Karen	261
	5565	Karen	166
	5565	Karen	261
	5566	Karen	166
	5566	Karen	261
	5567	Karen	166
	5567	Karen	261
	5568	Lois	582
	5569	Lois	582
	5570	Lois	582
	5571	Lois	582
	5576	Lois	583
	5577	Lois	583
	5578	Lois	583
	5579	Lois	583
	5584	Lois	584
	5585	Lois	584
	5586	Lois	584
	5587	Lois	584
	5592	Otto	136
	5592	Otto	446

	5593	Otto	136
	5593	Otto	446
	5594	Otto	136
	5594	Otto	446
	5609	Balzac	158
	5609	Balzac	280
	5610	Balzac	158
	5610	Balzac	280
	5611	Balzac	158
	5611	Balzac	280
	5612	Balzac	158
	5612	Balzac	280
	5613	Arthur	161
	5613	Arthur	276
	5614	Arthur	161
	5614	Arthur	276
	5615	Arthur	161
	5615	Arthur	276
	5616	Arthur	161
	5616	Arthur	276
	5631	Finian	303
	5632	Finian	303
	5633	Finian	303
	5634		

CONTENTS • TARTALOMJEGYZÉK • INHALTSVERZEICHNIS

New	Art. number	Name	Page
Új	Cikkszám	Név	Oldal
Neu	Art. nummer	Name	Seite

	6049	Ginger	186
	6050	Ginger	186
	6060	Elite	312
	6061	Elite	312
	6062	Elite	312
	6063	Elite	312
	6078	Polla	308
	6079	Polla	308
	6081	Dave	306
	6083	Dave	307
	6085	Dave	307
	6091	Lauren	307
	6092	Lauren	307
	6093	Lauren	307
	6094	Lauren	307
	6096	Logan	302
	6097	Logan	302
	6098	Logan	302
	6099	Logan	302
	6125	Merkur	279
	6126	Merkur	279
	6127	Merkur	279
	6128	Merkur	279
	6129	John	551
	6130	John	551
	6228	Rowena	95
	6230	Liam	550
	6250	Delion	356
	6258	Amadeo	86
	6259	Amadeo	86
	6260	Amadeo	86
	6270	Danton	552
	6294	Siren	371
	6299	Othello	69
	6300	Soma	310
	6301	Soma	310
	6302	Soma	310
	6303	Soma	310
	6304	Soma	310
	6305	Soma	310
	6306	Soma	314
	6307	Soma	314
	6308	Soma	314
	6309	Soma	314
	6310	Soma	314
	6320	Soma	314
	6329	Boswell	359
	6337	Aurel	62
	6338	Aurel	62
	6340	Linett	505
	6341	Aurel	305
	6342	Aurel	305
	6343	Aurel	305
	6344	Aurel	305
	6355	Solomon	87
	6356	Art flower	225
	6356	Art flower	315
	6357	Art flower	225
	6357	Art flower	315
	6358	Art flower	225

New	Art. number	Name	Page
Új	Cikkszám	Név	Oldal
Neu	Art. nummer	Name	Seite

	6358	Art flower	315
	6359	Art flower	225
	6359	Art flower	315
	6383	Trudy	476
	6389	Birdy	504
	6390	Birdy	504
	6408	Carter	482
	6409	Carter	482
	6410	Carter	482
	6418	Belmont	492
	6419	Belmont	492
	6420	Belmont	492
	6438	Tanisha	21
	6439	Tanisha	21
	6440	Tanisha	21
	6446	Waterfall	59
	6447	Waterfall	59
	6448	Harris	498
	6449	Waterfall	59
	6450	Kolmio	358
	6475	Hollis	356
	6486	Gavin	167
	6486	Gavin	260
	6487	Gavin	167
	6487	Gavin	260
	6487	Gavin	260
	6488	Gavin	167
	6488	Gavin	260
	6489	Gavin	167
	6489	Gavin	260
NEW	6490	Danuta	393
	6495	Philana	30
	6496	Philana	30
	6512	Karen	283
	6513	Karen	283
	6514	Karen	283
	6515	Karen	283
	6529	Larkin	329
	6530	Larkin	329
	6539	Harvey	329
	6545	Grando	219
	6546	Grando	219
	6547	Grando	219
	6548	Grando	219
	6549	Romilli	176
	6550	Romilli	176
	6559	Floresta	29
	6560	Floresta	29
	6569	Bowie	125
	6569	Bowie	475
	6570	Bowie	125
	6570	Bowie	475
NEW	6579	Leana	408
NEW	6580	Leana	408
NEW	6589	Ashton	411
NEW	6590	Ashton	411
	6591	Soma	319
	6592	Soma	319
	6593	Soma	319
	6594	Soma	319
	6635	Harmony lux	311

New	Art. number	Name	Page
Új	Cikkszám	Név	Oldal
Neu	Art. nummer	Name	Seite

	6636	Harmony lux	311
	6637	Harmony lux	311
	6638	Harmony lux	311
NEW	6639	Godric	460
NEW	6640	Godric	460
NEW	6649	Neva	144
NEW	6650	Neva	144
	6659	Cassandra	33
	6660	Cassandra	33
	6666	Karen	250
	6667	Karen	250
	6668	Karen	250
	6669	Karen	250
NEW	6670	Tithania	71
	6679	Athos	69
	6708	Rochelle	358
	6710	Dalfon	348
	6719	Mika	327
	6720	Mika	327
	6749	Paula	558
	6750	Paula	558
	6767	Nicolette	304
	6768	Nicolette	304
	6769	Nicolette	304
	6770	Nicolette	304
	6778	Berry	495
	6779	Berry	495
	6780	Berry	495
	6788	Maliet	145
	6789	Maliet	145
	6790	Maliet	145
	6790	Maliet	449
	6806	Larisha	179
	6808	Almus	125
	6809	Almus	125
NEW	6814	Ashton	411
NEW	6830	Roxana	38
NEW	6830	Roxana	368
	6835	Dave	306
	6836	Dave	306
	6837	Dave	306
	6838	Dave	306
	6846	Valentine	321
	6847	Valentine	321
	6848	Valentine	321
	6849	Valentine	321
	6857	Dalfon	348
	6858	Dalfon	349
	6859	Dalfon	349
NEW	6867	Thabita	364
NEW	6868	Thabita	364
NEW	6869	Thabita	364
	6882	Odin	106
	6882	Odin	270
	6883	Odin	106
	6883	Odin	270
	6884	Odin	106
	6884	Odin	270
	6885	Odin	106
	6885	Odin	270

New	Art. number	Name	Page
Új	Cikkszám	Név	Oldal
Neu	Art. nummer	Name	Seite

NEW	6907	Almond	406
NEW	6908	Almond	406
NEW	6909	Almond	406
NEW	6915	Gremio	123
NEW	6915	Gremio	474
	6929	Stacy	241
	6930	Stacy	241
	6949	Carnival	518
NEW	6958	Taneli	351
NEW	6959	Taneli	351
NEW	6960	Taneli	351
	6966	Jillian	370
	6967	Jillian	370
	6968	Etrusco	454
NEW	6969	Willow	42
NEW	6970	Willow	42
	6979	Osias	489
	6980	Osias	489
	6986	Norton led	324
	6987	Norton led	324
	6988	Norton led	324
	6989	Norton led	324
	6990	Lupe	514
NEW	6996	Fandral	365
NEW	6997	Fandral	365
	7006	Vlasta	450
	7008	Glitter rainbow	520
	7011	Lollipop rainbow	520
	7012	Minuet	254
	7012	Minuet	507
	7013	Minuet	254
	7013	Minuet	507
	7014	Minuet	254
	7014	Minuet	507
	7015	Minuet	254
	7015	Minuet	507
	7016	Minuet	254
	7016	Minuet	507
NEW	7017	Kaunas	170
NEW	7018	Kaunas	170
NEW	7019	Kaunas	170
NEW	7020	Kaunas	170
NEW	7021	Kaunas	170
NEW	7022	Kaunas	170
NEW	7023	Kaunas	171
NEW	7024	Kaunas	171
NEW	7025	Kaunas	171
NEW	7026	Minka	516
NEW	7027	Minka	516
NEW	7028	Minka	516
NEW	7029	Minka	516
NEW	7030	Minka	516
	7041	Susan	206
	7043	Susan	206
	7045	Susan	206
	7062	Flood	696
	7063	Flood	696
	7064	Flood	696
	7065	Flood	696
	7066	Flood	697

CONTENTS • TARTALOMJEGYZÉK • INHALTSVERZEICHNIS

New	Art. number	Name	Page
Új	Cikkszám	Név	Oldal
Neu	Art. nummer	Name	Seite

	7067	Flood	697
	7068	Flood	697
	7072	Petronel	232
	7076	Petronel	232
	7077	Petronel	232
	7078	Petronel	232
	7079	Petronel	232
	7091	Rustic 3	228
	7092	Rustic 3	228
	7093	Rustic 3	228
	7095	Rustic 3	228
	7099	Rustic 3	228
NEW	7109	Mendoza	661
NEW	7110	Mendoza	661
	7118	Evangeline	205
	7119	Evangeline	205
	7120	Evangeline	205
NEW	7127	Taverna	596
NEW	7128	Taverna	596
NEW	7129	Taverna	596
NEW	7130	Taverna	596
	7131	Beckworth	223
	7133	Beckworth	223
NEW	7134	Trogir	646
	7135	Beckworth	223
	7136	Beckworth	223
	7137	Aurelia	211
	7139	Aurelia	211
	7140	Aurelia	211
	7171	Art flower	224
	7173	Art flower	224
	7186	Katherine	189
	7187	Katherine	189
	7188	Katherine	189
	7189	Katherine	189
	7190	Katherine	189
	7191	Katherine	189
	7201	Tristan	194
	7202	Tristan	194
	7203	Tristan	194
NEW	7204	Ontario	661
	7205	Tristan	194
	7231	Rafaella	226
	7233	Rafaella	226
	7235	Rafaella	226
	7241	Rafaella	226
	7243	Rafaella	226
	7245	Rafaella	226
	7256	Fabiola	190
	7258	Fabiola	190
	7259	Fabiola	190
	7260	Fabiola	190
	7261	Fabiola	190
	7274	Edith	210
	7275	Edith	210
	7276	Edith	210
NEW	7317	Lippa	653
NEW	7318	Lippa	653
NEW	7319	Lippa	653
NEW	7320	Lippa	653

New	Art. number	Name	Page
Új	Cikkszám	Név	Oldal
Neu	Art. nummer	Name	Seite

	7361	Francesca	195
	7363	Francesca	195
	7365	Francesca	195
	7366	Colette	229
	7367	Colette	229
	7368	Colette	229
	7371	Francesca	227
	7372	Francesca	227
	7373	Francesca	227
	7375	Francesca	227
NEW	7396	Solin	664
NEW	7397	Solin	664
NEW	7476	Balimo	660
NEW	7477	Balimo	660
NEW	7478	Balimo	660
NEW	7479	Balimo	660
NEW	7494	Mizil	683
NEW	7502	Wellington	682
NEW	7503	Wellington	682
NEW	7504	Palanga	647
NEW	7505	Palanga	647
NEW	7506	Palanga	647
	7601	Ronan	96

CONTENTS • TARTALOMJEGYZÉK • INHALTSVERZEICHNIS

New	Art. number	Name	Page
Új	Cikkszám	Név	Oldal
Neu	Art. nummer	Name	Seite

	8154	Follina	652
	8163	Odessa	620
	8164	Odessa	620
	8165	Odessa	620
	8166	Atlanta	677
	8167	Atlanta	677
	8168	Atlanta	677
	8169	Seattle	644
	8170	Stuttgart	659
	8171	Regina	208
	8172	Regina	208
	8173	Regina	208
	8175	Regina	209
	8176	Regina	208
	8177	Regina	208
	8178	Regina	209
	8181	Monaco	602
	8182	Monaco	602
	8183	Monaco	602
	8184	Monaco	603
	8185	Monaco	603
	8186	Monaco	603
	8190	Darius	638
	8201	Velence	615
	8202	Velence	614
	8203	Velence	615
	8204	Velence	614
	8205	Velence	615
	8206	Velence	614
	8207	Velence	615
	8208	Velence	614
	8209	Velence	615
	8210	Velence	614
	8216	Velence	615
	8217	Velence	614
	8218	Velence	616
	8220	Stuttgart	659
	8227	Stuttgart	659
	8229	Seattle	644
	8232	Velence	616
	8234	Velence	616
	8236	Velence	616
	8238	Velence	616
	8240	Velence	616
	8243	Haga	636
	8244	Haga	636
	8245	Konstanz	630
	8246	Konstanz	630
	8247	Konstanz	630
	8248	Konstanz	630
	8261	Inox torch	678
	8262	Inox torch	678
	8263	Inox torch	678
	8264	Inox torch	678
	8265	Inox torch	679
	8266	Inox torch	679
	8267	Inox torch	679
	8268	Inox torch	679

New	Art. number	Name	Page
Új	Cikkszám	Név	Oldal
Neu	Art. nummer	Name	Seite

	8269	Genova	644
	8270	Oslo	634
	8271	Oslo	635
	8337	Bonn	684
	8338	Bonn	684
	8339	Bonn	684
	8341	Milano	612
	8342	Milano	612
	8343	Milano	613
	8344	Milano	613
	8345	Milano	613
	8346	Milano	613
	8359	Manhattan	640
	8365	Solar 1	688
	8366	Solar 1	688
	8370	Milano	610
	8371	Milano	610
	8372	Milano	610
	8373	Milano	611
	8374	Milano	611
	8375	Milano	611
	8376	Milano	610
	8377	Madrid	622
	8379	Madrid	623
	8380	Toronto	604
	8381	Toronto	604
	8382	Toronto	604
	8383	Toronto	604
	8384	Toronto	605
	8385	Toronto	605
	8387	Sydney	636
	8388	Sydney	636
	8389	Palermo	636
	8391	Toscana	609
	8392	Toscana	609
	8393	Toscana	609
	8394	Toscana	609
	8395	Toscana	609
	8396	Toscana	608
	8397	Toscana	608
	8398	Toscana	608
	8399	Toscana	608
	8400	Toscana	608
	8409	Roma	641
	8410	Roma	641
	8451	Nizza	606
	8452	Nizza	606
	8453	Nizza	606
	8454	Nizza	606
	8455	Nizza	606
	8458	Nizza	606
	8460	Toronto	605
	8476	Madrid	622
	8477	Madrid	622
	8478	Madrid	622
	8479	Madrid	623
	8480	Madrid	623
	8496	Hektor	638

New	Art. number	Name	Page
Új	Cikkszám	Név	Oldal
Neu	Art. nummer	Name	Seite

	8499	Hektor	638
	8510	Manhattan	640
	8511	Roma	641
	8517	Denver 4	639
	8518	Denver 4	639
	8541	Marlene	214
	8542	Marlene	214
	8543	Marlene	214
	8546	Marlene	214
	8547	Marlene	214
	8558	Orchidea	222
	8568	Marseille	625
	8569	Marseille	625
	8570	Marseille	625
	8578	Marseille	625
	8617	Marseille	624
	8618	Marseille	624
	8619	Marseille	624
	8620	Marseille	625
	8631	Annabella	220
	8632	Annabella	220
	8633	Annabella	220
	8634	Annabella	220
	8636	Annabella	221
	8637	Annabella	221
	8638	Annabella	220
	8670	Miami	618
	8671	Miami	618
	8674	Miami	618
	8675	Miami	618
	8676	Miami	618
	8677	Barcelona	621
	8678	Barcelona	621
	8679	Barcelona	621
	8680	Oslo	632
	8681	Oslo	635
	8682	Oslo	632
	8683	Stuttgart	659
	8684	Stuttgart	659
	8685	Stuttgart	659
	8686	Vigo	631
	8687	Vigo	631
	8696	New york	619
	8697	New york	619
	8698	New york	619
	8699	New york	619
	8700	New york	619
	8714	Tacoma	690
	8716	Oslo	632
	8717	Oslo	632
	8730	Baltimore	650
	8731	Baltimore	650
	8736	Oslo	635
	8737	Oslo	635
	8739	Oslo	635
	8740	Oslo	635
	8748	Innsbruck	640
	8749	Innsbruck	640

New	Art. number	Name	Page
Új	Cikkszám	Név	Oldal
Neu	Art. nummer	Name	Seite

	8753	Norvich	643
	8754	Norvich	643
	8757	Pescara	601
	8759	Pescara	601
	8763	Oslo	634
	8764	Oslo	634
	8766	Durango	639
	8767	Durango	639
	8776	Roma	641
	8794	Cardiff	650
	8795	Birmingham	640
	8796	Austin	662
	8797	Austin	662
	8799	Sevilla	642
	8800	Sevilla	642
	8811	Flossi	215
	8812	Flossi	215
	8813	Flossi	215
	8815	Flossi	215
	8829	Andorra	663
	8830	Andorra	663
	8832	Medina	666
	8833	Medina	666
	8834	Medina	666
	8835	Medina	666
	8847	Hamburg	658
	8848	Hamburg	658
	8849	Hamburg	658
	8850	Hamburg	658
	8873	Maribor	651
	8874	Maribor	651
	8888	Budapest	600
	8889	Budapest	600
	8890	Budapest	600
	8893	Trento	686
	8894	Trento	686
	8936	Catania	669
	8937	Catania	669
	8938	Catania	669
	8939	Catania	669
	8940	Rodez	644
	8948	Mora	688
	8949	Mora	688
	9919	Fix	442
	9920	Fix	442
	9921	Rolly	443
	9923	Rolly	443
	9926	Fix	442

CONTENTS • TARTALOMJEGYZÉK • INHALTSVERZEICHNIS

Name	Page
Név	Oldal
Name	Seite

Aaron	450
Abbey	547
Abc	504
Action	456, 457
Ada	426
Adeline	66, 67, 386
Adon	380
Adonias	346
Adrienne	49
Akron	648
Aksel	159, 480
Alabastro	419, 420, 421
Alberta	148
Albina	554
Aldona	75
Alessandra	184, 185
Aletta	218
Alexis	55
Alfons	326
Almada	598
Almond	406
Almus	125
Alvaro	90, 91
Alvorada	662
Alyson	47
Amadeo	86
Amalfi	672
Amarillo	686
Ambrosio	51
Amiel	465
Amy	309
Anais	53
Anastasia	82, 83
Andela	360
Andorra	663
Andra	395
Andrew	555
Aneta	80, 81
Aniela	45
Anja	328
Anna	182
Annabella	220, 221
Antoine	535
Antonia	528
Aquila	363
Arcadia	361
Ariel	471
Arno	484
Artemis	77
Art flower	224, 225, 315, 454
Art gold	415
Arthur	161, 276
Ashton	411
Aslan	147
Athen	192, 193
Athos	69
Ati	320
Atlanta	677
Aurel	62, 305
Aurelia	211
Austin	662
Avalon	39, 369

Name	Page
Név	Oldal
Name	Seite

Avery	546
Aviana	27
Aviva	532
Azra	47
Azuline	24
Balimo	660
Baloo	513
Balor	494
Balthasar	540
Baltimore	650
Balzac	158, 280
Band light	566, 567
Bank	482
Barcelona	621
Basil	290, 291, 460
Bastian	555
Bath	564
Batten light	560
Beata	536
Becca	537
Beckworth	223
Bee	505
Belano	100, 101
Belfast	648
Bellamy	368
Belmont	492
Benicio	347
Benita	394
Berbera	82
Berry	495
Beta	452
Betty	549
Bilbao	690
Billy	515
Birdy	504
Birmingham	640
Black torch	681
Blake	287
Blanka	462
Bloomy	427
Bona	647
Bonn	684
Boogie	474
Boswell	359
Bottom	443
Bowie	125, 475
Briella	58
Bruce	376
Budapest	600
Buffalo	665
Byron	557
Calista	146
Callia	60
Calvin	375
Cameron	143
Cara	328
Cardamom	12
Cardiff	650
Carly	124
Carmella	64, 388
Carnival	518
Carter	482

Name	Page
Név	Oldal
Name	Seite

Caspar	118
Cassandra	33
Catania	669
Cathy	511
Ceilo	68, 383
Celinda	357
Charles	432
Chile	670, 671
Cibyll	544
Cinnamon	168
Clark	486
Clip	500
Colette	229
Colin	484
Connor	309
Coralia	370
Corinna	178
Cortado	92, 93
Cressida	371
Cupola range	438
Dafina	389
Dalfon	348, 349
Damek	402
Damien	342
Danielle	181
Danila	197
Dannet	690
Danton	552
Danuta	393
Danny	378
Daria	52
Darius	638
Daron	137, 447
Darrington	599
Dave	306, 307
Delice	26
Delion	356
Dennis	501
Denver 4	639
Derek	135, 448
Detroit	676
Diana	455
Dimitri	102, 103, 475
Disky	433
Divina	31
Dobra	328
Dominic	492
Donald	574
Donatella	48
Donati	14, 15, 22
Dora	472
Dorka	473
Dorothea	191
Doug	142

CONTENTS • TARTALOMJEGYZÉK • INHALTSVERZEICHNIS

Name	Page	Name	Page	Name	Page	Name	Page
Név	Oldal	Név	Oldal	Név	Oldal	Név	Oldal
Name	Seite	Name	Seite	Name	Seite	Name	Seite
Hanson	558	Lentil	694	Milo	514	Pablo	116, 117, 264, 265
Harlow	93	Leon	510	Minka	516	Palanga	647
Harmony	454	Leonie	373	Minuet	254, 507	Palermo	636
Harmony lux	311, 424, 425	Leslie	450	Mirella	234	Pallas	36
Harold	530	Levi	122	Miroslaw	17, 128	Palmira	50
Harris	498	Levon	554	Misha	490	Panthea	63
Harvey	329	Liam	550	Mizil	683	Paris lux	515
Hecate	354	Lilian	207	Modesto	628, 629	Parov	95
Hekla	525	Lima	647	Mokka	382	Patric	486
Hektor	638	Lina	514	Molly	469	Paula	558
Helicopter	505	Linden	377	Monaco	602, 603	Pavel	405
Hestia	198, 199, 300, 301	Linett	505	Monet	19	Pavia	631
Hilary	247	Lionel	488	Montelle	356	Pearl classic	455
Holden	414	Lippa	653	Monty	478	Periodic	556
Hollis	356	Lisbon	674	Mora	688	Pescara	601
Holly	164, 165, 242, 243, 244, 245, 258, 259	Lite	588, 589	Morpheus	76	Peter	152, 286
Iduna	94	Logan	302	Morris	439	Petra	473
Igor	379	Lois	582, 583, 584, 585, 586, 587	Murry	343	Petrina	201
Indiana	110, 111	Loki	694	Nalani	463	Petronel	232
Ingrid	470	Lollipop 2	519	Natina	292, 293	Petunia	18
Innsbruck	640	Lollipop rainbow	520	Navia	652	Phaedra	431
Inox torch	678, 679	Lorna	404	Nedda	432	Philana	30
Inverness	341, 654	Lucas	396, 397, 398, 544, 693	Nesna	651	Phoenix	668
Iris	426	Ludovic	569	Nesrin	151	Picture guard	568
Jakub	552	Lupe	514	Neva	144	Picture light	568
Jarina	200	Lupita	350	Neville	171	Picture slim	569
Jasna	389	Mac	160, 277	New york	619	Polla	308
Jeff	496	Maddox	574	Niagara	534	Portia	357
Jenna	308	Madrid	622, 623	Nicolas	156, 480	Primrose	372
Jeremy	542	Magnus	514	Nicolette	304	Pueblo	686
Jezabel	32	Malia	132, 449	Ninelle	37	Push light	515
Jillian	370	Maliet	145, 449	Nizza	606	Quadro	70
Jim	549	Mandal	665	Noah	497	Rafaella	226
Joel	222	Manhattan	640	Nolan	376	Ramsey	122
John	551	Manorca	141	Norena	139	Randy	592
Jolly	422	Maple	409	Norton	325	Rattan	112, 262
Justin	491	Marcella	181	Norton led	324	Raul	485
Kaia	138	Marian	212, 213	Norvich	643	Regina	208, 209
Kamala	107	Maribor	651	Oberon	104, 105	Remote control	332
Karen	166, 250, 261, 283	Marlene	214	Octav	392	Renata	72
Kassia	177	Marlon	169	Odessa	620	Rheia	58
Katherine	189	Marseille	624, 625	Odin	106, 270	Rice	439, 513
Katowice	680	Marshal	518	Oleg	576, 577	Rob	400, 401
Kaunas	170, 171	Martha	203, 316	Ontario	661	Rochelle	358
Kinga	462	Marvel	235	Opale	433	Rock	524
Kobald	572, 573	Mason	380	Opava	691	Rodez	644
Kolmio	358	Matea	360	Ophelia	340	Rodion	342
Konrad	162, 163, 251, 282	Matt	553	Ophus	451	Rolly	443
Konstanz	630	Medina	666	Opole	645	Rolly pull	443
Krobia	689	Melissa	196	Orchidea	222	Roma	641
Kyle	142	Melora	44	Orlando	468	Romilli	176
Lacey	296, 297	Mendoza	661	Oscar	390, 391	Ronald	485
Lagertha	355	Meredith	56, 57	Osias	489	Ronan	96
Lamar	119, 267	Meridia	43	Oslo	632, 634, 635	Ronnie	477
Lambert	543	Merkur	278, 279	Ostrava	691	Rosanna	180
Lanny	126, 127, 459	Miami	618	Oswald	393	Rotem	155, 274
Laretta	416	Miguel	79, 294,	Othello	69	Round	438
Larisha	179	Mika	327	Otilia	75	Rowena	95
Larkin	329	Milano	610, 611, 612, 613	Otto	136, 446	Roxana	38, 368
Lauren	307	Millie	521	Owen	129	Roxy	441
Leana	408			Ozone	525	Ruben	539
						Rufin	123, 481

CONTENTS • TARTALOMJEGYZÉK • INHALTSVERZEICHNIS

Name	Page	Name	Page	Name	Page	Name	Page
Név	Oldal	Név	Oldal	Név	Oldal	Név	Oldal
Name	Seite	Name	Seite	Name	Seite	Name	Seite
Rupert	97	Solin	664	Taylor	373	Vesuvius	525
Rustic 3	228	Solomon	87	Tekla	491	Vida	143
Sadie	165	Soma	310, 314, 319	Tesia	384, 385	Vigo	631
Salazar	240	Sonal	467	Thabita	364	Vino	427
Salem	467	Sonnet	575	Thalassa	359	Vivienne	153, 188, 252, 281
Salvador	662	Sophie	472	Thelma	288	Vlasta	450
Samson	483	Soraya	298, 299	Theodor	478	Warsaw	673
Saphira	362	Sorina	204	Thomas	461	Wasabi	522
Scottie	430	Sorrento	626, 627	Timothy	493	Waterfall	59
Scroll	426	Spencer	555	Tithania	71	Wellington	682
Seattle	644	Spiral	428	Togo	546	Wendy	464
Sedona	355	Spot fashion	593	Tom	417	Willow	42
Selena	46	Spot relight	590, 591	Toma	541	Wolimir	540
Sevilla	642	Stacy	241	Tony	538	Xenia	94
Shane	140	Stefany	433	Top	217	Yago	548, 683
Shaun	578, 579, 580	Steve	531	Topeka	643	Yola	689
Sheila	25	Streak light	563	Tornado	350	Yvette	461
Shepherd	512	Stripe	414	Toronto	604, 605	Zadar	685
Sherwood	408	Stuttgart	659	Toscana	608, 609	Zagreb	669
Silas	550	Sudan	230	Trento	686	Zahara	113
Silistra	642	Sullivan	20	Trevor	399	Zelkova	16, 476
Simple	428	Susan	206	Trincola	134	Zenaida	23
Sinopia	174	Svetlana	54	Tristan	194	Zenith	362
Sintra	667	Sydney	636	Trogir	646	Zenon	545
Siren	371	Tacoma	690	Trudy	476	Zeus	108, 271
Sirius	366, 367	Taleb	403	Tulio	40	Zilah	645
Slava	541	Tamara	241	Ufo	434, 435, 436, 437	Zille	94
Slim	561	Tamino	407	Ulla	57	Zircon	88, 89, 284, 285
Smart wifi bulb	332, 333	Taneli	351, 352, 353	Valentine	321	Ziva	371
Smerlato	438	Tanesha	21	Valter	361	Zombor	649
Soft	565	Tarien	239	Varna	646	Zora	246
Solange	249	Tartu	656, 657	Velence	614, 615, 616		
Solar 1	688	Taverna	596	Vera	61		
Soley	429	Tayla	374	Vesta	363		

rabalux[®]
www.rabalux.com



www.rabalux.com

