



EGLO
my light | my style



2022/23

INTERIOR LIGHTING

WOHNRAUMLEUCHTEN
LUMINAIRES INTÉRIEURS



Dear business partners and faithful friends of EGLO,

We are proud to present our new luminaire highlights, inspired by the latest trends and styles of the 2022/23 season. Sustainability, with a focus on protecting the planet and its resources, is still very much in demand. Protecting the environment while at the same time creating a future for many generations to come has become part of a global commitment. The call for freedom, humility, a return to nature, and security is louder than ever, especially in these times of crisis. It is more important to ever to be able to feel secure and at ease in your own home. Our Boho, Wabi Sabi and New Nordic Style fittings are designed to meet this need. All these home decorating trends combine simplicity, warm colours and harmony. The calm, minimalist styles of the season, with their occasional rough edges, are enhanced by rich metallic tones in brass and bronze, creating small eye-catching highlights in your living room. Be inspired and explore this year's world of EGLO lighting trends.

I hope you enjoy browsing our new main catalogue.

Geschätzte Geschäftspartner*innen, treue EGLO Freund*innen,

Freuen sie sich auf unsere Leuchten-Highlights, angelehnt an die aktuellen Trends und Styles der Saison 2022/23. Nach wie vor sind Trends im Sinne der Nachhaltigkeit gefragt, diese bauen auf dem Schutz unseres Planeten und seiner Ressourcen auf. Es ist Teil einer globalen Verpflichtung geworden, die Umwelt zu schützen und gleichzeitig eine Zukunft für viele kommende Generationen zu schaffen. Gerade in den aktuellen Krisenzeiten ist der Ruf nach Freiheit, Demut und Natürlichkeit sowie Sicherheit lauter denn je. Umso wichtiger ist es, sich in seinen eigenen 4 Wänden geborgen und zu Hause zu fühlen. Mit Einrichtungen im Boho, Wabi Sabi oder New Nordic Style wird diesem Bedürfnis Rechnung getragen. All diese Wohntrends verbinden Einfachheit, warme Farbwelten und Harmonie miteinander. Die ruhigen und minimalistischen, manchmal auch unvollkommenen Styles der Saison, werden mit wertigen Metalltönen in Messing und Bronze abgerundet und kreieren kleine Eyecatcher im Wohnraum. Lassen Sie sich inspirieren und tauchen Sie ein in die Welt der EGLO Leuchten-Trends des Jahres.

Ich wünsche Ihnen viel Freude beim Durchschauen des neuen Hauptkatalogs.

Chers partenaires, chers amis d'EGLO,

Découvrez nos produits phares inspirés des tendances et styles actuels de la saison 2022/23. Cette fois encore, les tendances recherchées sont associées au développement durable, car elles favorisent la protection de notre planète et de ses ressources. Dans le monde entier, on s'est fixé le devoir de protéger l'environnement tout en créant un avenir pour les générations futures. En raison des périodes de crise que nous traversons actuellement, nous recherchons plus que jamais la liberté, l'humilité, la nature et la sécurité. Il est donc d'autant plus important de se sentir à l'aise et bien à l'abri chez soi. Un aménagement dans le style Boho, Wabi Sabi ou New Nordic permet de répondre à ce besoin. Tous ces styles allient simplicité et harmonie à un univers de couleurs chaleureuses. Les styles paisibles et minimalistes, voire imparfaits de cette saison sont complétés par des tons métalliques de qualité en laiton et en bronze pour attirer tous les regards. Laissez-vous inspirer et plongez dans le monde des tendances d'éclairage EGLO de l'année.

Je vous souhaite beaucoup de plaisir à consulter le nouveau catalogue.

Mag. René Tiefenbacher
CEO EGLO Group

CONTENT

INHALT
CONTENU



EGLO CONNECT

P.010 - 097



EGLO ACCESS

P.098 - 113



LIGHTING FAMILIES

FABRIC LUMINAIRES

STOFFLEUCHTEN
LUMINAIRES À TEXTIL

P.114 - 191



LIGHTING FAMILIES

WOOD LUMINAIRES

HOLZLEUCHTEN
LUMINAIRES À BOIS

P.192 - 211



LIGHTING FAMILIES

STANDARD LUMINAIRES

STANDARD LEUCHTEN
LUMINAIRES STANDARD

P.212 - 315



LIGHTING FAMILIES

GLASS CHANDELIERS

LEUCHTENFAMILIEN
FAMILIES DE LUMINAIRES

P.316 - 325



HANGING & PENDANT LUMINAIRES

HÄNGE- & PENDELLEUCHTEN
LUMINAIRES SUSPENSIONS

P.326 - 447



WALL & CEILING LUMINAIRES

WAND- & DECKENLEUCHTEN
APPLIQUES & PLAFONNIERS

P.448 - 595



BATH & MIRROR LUMINAIRES

BAD- & SPIEGELLEUCHTEN
LUMINAIRES DE BAIN & MIROIR

P.596 - 655



SPOTS & TRACK LUMINAIRES

SPOTS- & SCHIENENLEUCHTEN
SPOTS & LUMINAIRES SUR RAIL

P.656 - 749



CLIP & PLUG LUMINAIRES

KLEMM- & STECKERLEUCHTEN
LUMINAIRES À PINCE & SUR PRISE

P.750 - 755



TABLE & FLOOR LUMINAIRES

TISCH- & STEHLEUCHTEN
LUMINAIRES DE TABLE & LAMPADAIRES

P.756 - 797



OFFICE TABLE & FLOOR LUMINAIRES

OFFICE TISCH- & STEHLEUCHTEN
LUMINAIRES DE TABLE & LAMPADAIRES À BUREAU

P.798 - 831



CHILDREN LUMINAIRES

KINDERLEUCHTEN
LUMINAIRES POUR ENFANTS

P.832 - 837



KITCHEN & FUNCTION LUMINAIRES

KÜCHEN- & FUNKTIONSLEUCHTEN
LUMINAIRES FONCTIONNELS & DE CUISINE

P.838 - 843



ACCESSORIES

ZUBEHÖR
ACCESSOIRES

P.844 - 847



INDEX & LEGEND

INDEX & ERKLÄRUNG
INDEX & LÉGENDE

P.848 - 872



EGLO TREND HIGHLIGHTS

2022/23



The EGLO design team has once again drawn on current mega-trends as a source of inspiration for the 2022/23 season. The new EGLO products' use of shape and colour, choice of materials, and overall aesthetic harmonise perfectly with both contemporary and future living trends. Minimalism and the increasingly popular use of materials and colours such as brass and earth tones have had a particularly strong influence on this season's luminaire designs.

Auf Basis der Megatrends hat sich das Design-Team von EGLO auch für die Saison 2022/23 inspirieren lassen. Mit ihrer Formsprache, Farbgebung sowie den verwendeten Materialien fügen sich die EGLO Neuheiten in die aktuellen wie auch zukünftigen Wohntrends ein. Der Trend des Minimalismus sowie die Verwendung von Materialien und Farben wie Messing und Erdtöne haben auf die aktuellen Leuchten-Designs besonderen Einfluss genommen.

Sur la base des mégatendances, l'équipe de conception EGLO a également été inspirée pour la saison 2022/23. Avec leur langage visuel, leur palette de couleurs et les matériaux utilisés, les innovations EGLO s'intègrent dans les tendances de la vie d'aujourd'hui et de demain. La tendance au minimalisme et l'utilisation de matériaux et de couleurs tels que le laiton et les tons de terre ont eu une influence particulière sur les conceptions actuelles de nos luminaires.

Minimalism - The art of less, the conscious reduction of shapes and colours to the bare essentials, is reflected in our luminaires. Clear and simple shapes and plain colours combine to create a calm atmosphere, in keeping with the maxim "less is more". Warm grey tones and timber elements give the room a welcoming touch, adding atmospheric highlights and offering a harmonious stage for your entire living space to work its magic without any distractions.

Minimalismus - Der bewusste Verzicht und die Kunst, Form und Farbe auf ein Minimum zu reduzieren, spiegelt sich in unseren Leuchten wider. Frei nach dem Prinzip „Weniger ist mehr“ sorgen klare und einfache Formen sowie schlichte Farben für eine ruhige Atmosphäre. Für die nötige Gemütlichkeit setzen warme Grautöne oder Holzelemente stimmungsvolle Akzente und bieten eine harmonische Bühne, um den gesamten Raum ganz ohne Ablenkung für sich wirken zu lassen.

Le minimalisme - Nos lampes reflètent un renoncement volontaire et l'art de réduire au minimum formes et couleurs. Selon le principe « faire plus avec moins », des formes claires et simples et des couleurs unies créent une atmosphère paisible. Pour le confort, des tons gris chauds ou des éléments en bois mettent en place une ambiance agréable et un décor harmonieux pour vous permettre de travailler dans une pièce sans aucune distraction.



ONEDA





MANZANARES

Brass - Brass so popular back in the 50s and 60s, is currently enjoying a new wave of popularity. Skilfully paired with contrasting materials, the gleaming metallic hues of brass bring a touch of luxury to living spaces without appearing old-fashioned. We have incorporated the high-quality material into our new luminaire models and combined it with diverse other materials to create captivating modern designs that can be integrated into a variety of interiors, from urban to classical to minimalist.

Messing - Der bereits in den 50er und 60er Jahren so populäre Messingtrend erfreut sich aktuell an neuer Beliebtheit. Gekonnt kombiniert und kontrastreich in Szene gesetzt, bringt Messing mit seinem strahlenden Metallton einen Hauch von Luxus in die Wohnräume, ohne altmodisch zu wirken. Das hochwertige Material haben wir in unsere neuen Leuchten-Modelle einfließen lassen und in Kombination mit verschiedenen Materialien charmante und moderne Designs geschaffen, die sich in unterschiedliche Einrichtungen von urban über klassisch bis hin zu minimalistisch integrieren lassen.

Le laitton - La tendance du laitton, déjà si populaire dans les années 50 et 60, est actuellement à nouveau au goût du jour. Habilement combiné et mis en scène avec de riches contrastes, le laitton avec sa teinte métallique brillante apporte une touche de luxe aux espaces de vie sans paraître démodé. Nous avons incorporé ce matériau de haute qualité dans nos nouveaux modèles de luminaires et, en combinaison avec divers matériaux, avons créé des designs charmants et modernes qui peuvent être intégrés à des aménagements différents, qu'ils soient notamment urbains, classiques ou encore minimalistes.

Warm earth tones - The very popular back-to-nature trend has also brought about a significant shift in the field of design. More and more people have been embracing a return to nature in recent years and the associated use of natural materials has also left its mark on the world of colour, heralding the rise of brown as the new black. The colour brown in all its many facets can be beautifully paired with almost any other colour and, thanks to its diverse earthy tones, not only lends our living spaces a touch of naturalness, but also conveys a sense of warmth and comfort. Combining this year's popular colour trend with wood and brass elements helps accentuate its distinctive appeal.

Warme Erdtöne - Der starke Trend hin zu mehr Natürlichkeit hat auch im Design einen bedeutsamen Wandel bewirkt. Die in den letzten Jahren deutlich an Bedeutung gewonnene Verbundenheit zur Natur und die damit einhergehende Verwendung von natürlichen Materialien hat auch die Farbwelt geprägt und lässt Braun als das neue Schwarz triumphieren. Braun in all seinen Facetten lässt sich hervorragend kombinieren und verleiht unseren Wohnräumen durch seine vielfältigen Erdtöne nicht nur einen Hauch von Natürlichkeit, sondern vermittelt Gemütlichkeit und Behaglichkeit gleichermaßen. Die Kombination mit Holz oder Messing verleiht der neuen Trendfarbe ihre besonderen Akzente.

Des tons chauds de terre - La forte tendance vers un caractère plus naturel a également entraîné un changement significatif dans notre conception. Le lien avec la nature, qui a grandement gagné en importance ces dernières années, et l'utilisation associée de matériaux naturels ont également façonné l'univers des couleurs : c'est ainsi que le brun a détrôné le noir. Le brun sous toutes ses facettes peut être parfaitement combiné et, avec ses divers tons de terre, non seulement donner à nos salons une touche naturelle, mais aussi procurer confort et bien-être dans le même temps. La combinaison de cette nouvelle couleur tendance avec le bois ou le laiton lui confère ses accents si particuliers.



VALDIOLA

Look out for this Logo!

Achten Sie auf das Logo!

Soyez attentif au logo !

What is a forest?

A peaceful oasis, the green lungs of the world, and an adventure playground for children of all ages!

The Forest Stewardship Council® (FSC®) is a global, not-for-profit organisation dedicated to the promotion of responsible forest management worldwide. The FSC® defines standards for responsible forest management in accordance with established principles that are developed and supported by stakeholders from the environmental, social and economic spheres. For more information, please see www.fsc.org.

Was ist Wald für uns?

Eine Oase der Ruhe, die Lunge der Welt oder ein Abenteuerspielplatz für große und kleine Kinder!

Das Forest Stewardship Council® (FSC®) ist eine globale, gemeinnützige Organisation, mit dem Zweck verantwortungsvolle Waldbewirtschaftung weltweit zu fördern. FSC® definiert Standards für eine verantwortungsvolle Waldbewirtschaftung nach festgelegten Prinzipien, die von Interessenvertretern aus den Bereichen Umwelt, Soziales und Wirtschaft entwickelt und getragen werden. Für weitere Informationen besuchen Sie www.fsc.org.

Que représente la forêt pour nous ?

Une oasis de calme, les poumons du monde ou un terrain de jeu d'aventure pour les enfants de tous âges !

Le Forest Stewardship Council® (FSC®) est une organisation internationale à but non lucratif dont le but est de promouvoir une gestion forestière responsable dans le monde entier. Le FSC® définit des normes de gestion forestière responsable selon des principes établis qui sont développés et soutenus par les parties prenantes des secteurs environnemental, social et économique. Pour plus d'informations, veuillez consulter www.fsc.org.

Look out for FSC® -certified products!
Achten Sie auf FSC® -zertifizierte Produkte!
Soyez attentif aux produits certifiés FSC® !



The mark of
responsible forestry

DIGITAL CATALOGUE

This year, we are also making the main catalogue in front of you available online, including lots of extra information and additional features. In addition to search and filter functions, the online catalogue includes extensive product photos, videos and additional information, complementing the paper edition wonderfully. Take a look at <https://catalogue.eglo.com>

In diesem Jahr präsentieren wir den vor Ihnen liegenden Hauptkatalog wieder als Online-Katalog mit vielen Zusatzinformationen und zusätzlichen Features. Neben Such- und Filterfunktionen bietet der Online-Katalog mit reichhaltigen Produktabbildungen, Videos und zusätzlichen Informationen einen erheblichen Mehrwert zur gebundenen Ausgabe. Klicken Sie sich rein unter <https://catalogue.eglo.com>

Cette année, nous présentons à nouveau une version en ligne du catalogue général. Cette version contient de nombreuses informations et fonctionnalités complémentaires. Outre les fonctionnalités de recherche et de filtrage, le catalogue en ligne propose de nombreuses illustrations de produits, des vidéos et des informations complémentaires : une valeur ajoutée considérable par rapport à la version papier. Cliquez ici pour le découvrir : <https://catalogue.eglo.com>



99795

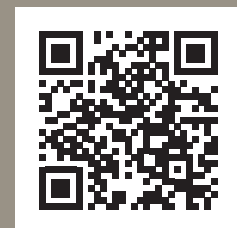

connect.2









































 **zigbee**  **Bluetooth®**

Discover the smart world



OVERVIEW

EGLO CONNECT.Z

 CONNECT-Z SENSOR p. 21	 CONNECT Z p. 21	 ANCHORENA-Z p. 22-23	 SALVILANAS-Z p. 24-25	 LOBINERO-Z p. 26	 ZILLERIO-Z p. 26	 ANDABAIA-Z p. 27	 TELIMBELA-Z p. 28-29
 TOLLOS-Z p. 30	 ROMAO-Z p. 30-31	 MONTEMORELOS-Z p. 32-33	 TOTARI-Z p. 33	 GENOVESE-Z p. 33	 PARRAPOS-Z p. 34-35	 PARANDAY-Z p. 36-37	 CALAGRANO-Z p. 37
 PADROGIANO-Z p. 38-40	 VALDELAGRANO-Z p. 42	 SIMOLARIS-Z p. 42-43	 MARGHERA-Z p. 44-45	 CAMINALES-Z p. 46	 SALICETO-Z p. 47	 LOMALTAS-Z p. 48	 TABIANO-Z p. 49
 JUAREZA-Z p. 49	 FRAIOLI-Z p. 50-51	 TOTARI-Z p. 52-53	 LANCIANO-Z p. 54	 CAPASSO-Z p. 55	 SILERAS-Z p. 55	 SAVATARILA-Z p. 56-57	 SALITERAS-Z p. 57
 TURCONA-Z p. 58, 62-63	 HERRORA-Z p. 60	 SALOBRENA-Z p. 64-67	 FUEVA-Z p. 68-79	 ROVITO-Z p. 80-83	 LED STRIPE-Z p. 84-85	 LM_LED_E27 p. 86-97	 LM_LED_GU10 p. 87
 LM_LED_E14 p. 87							



This product is available in different colors and shapes./ Dieser Artikel ist in unterschiedlichen Farben und Formen verfügbar.
Cet article est disponible en différentes couleurs et formes.



connect.z combines two control technologies in one system

connect.z vereint zwei Steuerungstechnologien in einem System

connect.z réunit deux technologies de commande au sein d'un même système



ZigBee is far and away the most widely used standard in the smart home world.

ZigBee ist der am weitesten verbreitete Standard in der Smart Home Welt.

ZigBee est le protocole le plus répandu au monde dans le domaine du Smart Home.

ADVANTAGES :

- › Mesh network
- › Direct connection with Amazon Echo and Google Home
- › Compatible with products from different manufacturers
- › High level of security
- › Easy setup
- › Energy efficient

VORTEILE:

- › Mesh-Netzwerk
- › Direkte Verbindung mit Amazon Echo und Google Home
- › Herstellerübergreifend kompatibel
- › Hohe Sicherheit
- › Einfache Einrichtung
- › Energieeffizient

AVANTAGES:

- › Réseau maillé
- › Connexion directe à Amazon Echo et Google Home
- › Compatible indépendamment du fabricant
- › Sécurité élevée
- › Installation facile
- › Économe en énergie

connect.2



Bluetooth is an established standard in the digital world.
Bluetooth ist ein etablierter Standard in der digitalen Welt.
Bluetooth est un standard de communication reconnu dans le monde numérique.

ADVANTAGES:

- › Local & secure network
- › Protocol is mainly audio (low debit)
- › Mesh network: Elements are receivers and senders
- › Easy setup
- › Usable offline
- › Energy efficient

VORTEILE:

- › Lokales & sicheres Netzwerk Protokoll hauptsächlich Audio (Low Debit)
- › Mesh-Netzwerk: Elemente sind Empfänger und Sender
- › Einfache Einrichtung
- › Offline nutzbar
- › Energieeffizient

AVANTAGES:

- › Réseau local et sûr
- › Protocole essentiellement audio (bas débit)
- › Réseau maillé : les éléments sont l'émetteur et le récepteur
- › Installation facile
- › Utilisable hors-ligne
- › Économe en énergie

Light up your world!

Bringen Sie Licht in Ihren Alltag!
Illuminez votre quotidien !



connect.z offers a wide range of lamps and lighting equipment. Select products from the following options according to your needs:
connect.z bietet ein großes Sortiment an Leuchten und Leuchtmitteln. Wählen Sie die Produkte ganz nach Ihren Bedürfnissen aus folgenden Varianten:
connect.z propose une large gamme de luminaires et d'ampoules. Sélectionnez les produits en fonction de vos besoins parmi les variantes suivantes :

Warm White

Neutral White

Tunable White

Individual light from 50,000 white tones.
Individuelles Licht aus 50.000 Weißtönen.
Luminaire individuel à 50 000 tons de blanc.

TW + RGB Colors

Diverse lighting selection from 50,000 white tones and 16 million colours.
Vielseitige Lichtauswahl aus 50.000 Weißtönen und 16 Mio. Farben.
Sélection étendue de luminaires à 50 000 tons de blanc et 16 millions de couleurs.

Enjoy relaxing moments!
Genießen Sie entspannte Momente!
Profitez de moments de détente !

Stay focussed & efficient!
Bleiben Sie konzentriert & leistungsfähig!
Restez concentré(e) et performant(e) !

Start the day fresh every morning!
Starten Sie jeden Morgen frisch in den Tag!
Commencez la journée du bon pied !

Create the perfect atmosphere!
Kreieren Sie Ihr perfektes Ambiente!
Créez votre ambiance parfaite !



Enjoy many useful convenience features: Es erwarten Sie viele nützliche Komfortfunktionen: De nombreuses fonctionnalités utiles vous attendent pour votre confort :



TIMERS AND CALENDARS / TIMER UND ZEITPLÄNE/ MINUTERIE ET CALENDRIER

Make your daily life easier with timers and calendars.
Wake up relaxed with the simulated sunrise.

Unterstützen Sie Ihren Alltag mit Timern und Zeitplänen. Entwickeln Sie eigene Lichtroutinen und machen Sie Ihr Leben leichter.

Facilitez-vous la vie à l'aide de la fonction minuterie et calendrier.
Réveillez-vous en douceur grâce au simulateur de lever de soleil



LIGHT ALARM CLOCK / LICHTWECKER/ REVEIL LUMINEUX

You'd rather not start your day in a bad mood? Wake up relaxed with the simulated sunrise.

Keine Lust mit schlechter Laune in den Tag zu starten? Entspannt aufwachen mit dem simulierten Sonnenaufgang.

Pas envie de commencer la journée de mauvaise humeur ? Réveillez-vous en douceur grâce au simulateur de lever de soleil.



DISCO FUNCTION/MODE / DISCOFUNKTION/MODUS/ FONCTION/MODE DISCO

For the perfect party mood, the disco function synchronises the light to the beat of your favourite songs.

Für die perfekte Partystimmung schaltet die Discofunktion das Licht passend zum Beat Ihres Lieblingssongs.

Pour une ambiance festive parfaite, la fonction disco enclenche le luminaire au rythme de votre chanson préférée.



PRESENCE SIMULATOR / ANWESENHEITSSIMULATION/ SIMULATEUR DE PRESENCE

Protect your home with the convenient presence simulator. Variable time intervals allow the system to turn the lights on and off to simulate your presence at home and deter unwanted guests.

Schütze Sie Ihr Zuhause mit der komfortablen Anwesenheitssimulation. Dank variabler Zeitintervalle simuliert das System durch Ein- und Ausschalten der Beleuchtung die Anwesenheit im Haus und schreckt so ungebetene Gäste ab.

Protégez votre domicile à l'aide du très pratique simulateur de présence. Le système simule votre présence en allumant et en éteignant les lumières à intervalles variables et décourage ainsi les invités indésirables.



VOICE COMMANDS / SPRACHSTEUERUNG/COMMANDE VOCALE

More convenient! Turn the light on whenever you want with only a voice command.

Noch komfortabler! Mit nur einem Sprachbefehl schaltet sich das Licht nach Ihren Wünschen an und aus.

C'est encore plus confortable ! Allumez votre luminaire comme vous le souhaitez d'une simple commande vocale.

Control options

Steuerungsmöglichkeiten
Possibilités de commande



Set your smart home as you prefer! With the app, voice commands, or remote control.

Steuern Sie Ihr Smart Home wie Sie es möchten! Via App, Sprachsteuerung oder mit der Fernbedienung.

Commandez votre Smart Home comme vous le souhaitez ! Via l'appli, la commande vocale ou la télécommande.



APP CONTROL

Use the free app for smartphone, tablet, or smartwatch.

Nutzen Sie die kostenlose App für das Smartphone, Tablet oder die Smartwatch.

Utilisez l'appli gratuite sur votre smartphone, votre tablette ou votre montre connectée.



VOICE COMMANDS

Use intelligent voice assistants such as Google Home and Amazon Alexa.

Nutzen Sie intelligente Sprachassistenten wie Google Home und Amazon Alexa.

Utilisez des assistants vocaux intelligents comme Google Home ou Amazon Alexa.



REMOTE CONTROL

Use the practical remote connect.z operation at any time.

Nutzen Sie auch jederzeit die praktische connect.z Fernbedienung.

Vous pouvez aussi utiliser à tout moment la télécommande connect.z.



CONNECT.Z ACCESSORIES

Use clever accessories such as the movement sensor and much more.

Nutzen Sie cleveres Zubehör wie z.B. den Bewegungssensor uvm.

Utilisez des accessoires malins tels que le capteur de mouvement et bien d'autres encore.



DIMMER FUNCTION

Use the practical dimmer function via app, speech command or remote control.

Nutzen Sie die praktische Dimmfunktion via App, Sprachbefehl oder Fernbedienung.

Utilisez la fonction de gradation via l'appli, la commande vocale ou la télécommande.

One system, many possibilities!

Ein System – viele Möglichkeiten!
Un système, de nombreuses possibilités!



No matter how you start, you can integrate new products into your connect.z system at any time and gradually expand your smart home.
Egal wie Sie starten, Sie können jederzeit neue Produkte in Ihr connect.z System integrieren und Ihr smartes Zuhause nach und nach erweitern.
Quel que soit votre choix, vous pouvez à tout moment intégrer de nouveaux produits à votre système connect.z et améliorer progressivement votre maison intelligente.

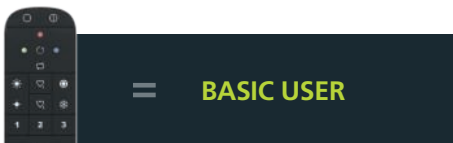

BASIC USER

All you need to start is a connect.z product and the remote control. No internet connection is required and you have access to:

Sie benötigen zum Start lediglich ein connect.z Produkt und die Fernbedienung. Es wird kein Internetzugang benötigt und Sie haben Zugriff auf:

Pour démarrer, il vous suffit d'un produit connect.z et de la télécommande. Aucune connexion Internet n'est nécessaire. Vous avez accès aux :

Standard functions:

Standardfunktionen:

Fonctionnalités standard :

- › Select colour/ Farbauswahl/ sélection de couleur
- › Change colour/ Farbwechsel/ changement decouleur
- › Dim/ Dimmen/ gradation
- › Favourites (2x)/ Favoriten (2x)/ favoris (2x)
- › Groups (3x)/ Gruppen (3x)/ groupes (3x)
- › Candle mode/ Kerzenmodus/ mode bougie

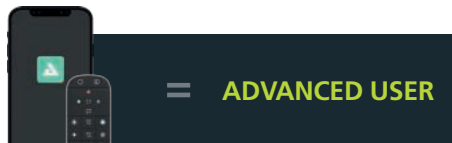

ADVANCED USER

Besides the standard functions, would you also like access to the practical convenience features? Then you need only your smartphone or tablet and the Awox app. This app allows you to control your lights via Bluetooth®.

Sie möchten zu den Standardfunktionen auch noch Zugriff auf die praktischen Komfortfunktionen haben? Dann benötigen Sie nur Ihr Smartphone oder Tablet und die Awox App. Mit der App haben Sie die Möglichkeit, Ihre Leuchten über Bluetooth® zu steuern.

Outre les options standard, vous souhaitez également pouvoir utiliser les fonctionnalités de confort les plus pratiques ? Pour cela, vous avez seulement besoin de votre smartphone ou de votre tablette et de l'appli Awox. L'appli vous permet de commander vos luminaires via Bluetooth®.

Standard functions + convenience features/ Standardfunktionen + Komfortfunktionen / Fonctionnalités standard + confort

- › Light alarm clock/ Lichtwecker/ réveil lumineux
- › Presence simulation/ Anwesenheitssimulation/ simulateur de présence
- › Disco function/ Discofunktion/ fonction disco
- › Timers & timetables /Timer & Zeitpläne/ minuteur et calendrier
- › Accessories can be incorporated/ Einbindung von Zubehör möglich/ connexion d'accessoires possible



POWER USER

Use the system's full potential and control your smart home through the Awox app using WIFI or Bluetooth® as well as integrating a voice assistant into the system. This gives you:

Nutzen Sie das volle Potenzial des Systems und steuern Sie Ihr Smart Home über die Awox App mithilfe von WLAN oder Bluetooth® und integrieren Sie zusätzlich noch einen Sprachassistenten in das System. So mit erhalten Sie:

Exploitez tout le potentiel du système en commandant votre Smart Home grâce à l'appli Awox via le réseau Wi-Fi ou Bluetooth®, et intégrez également un assistant vocal au système. Vous obtenez ainsi :

Standard functions + convenience features + voice commands*

Standardfunktionen + Komfortfunktionen + Sprachsteuerung*

Fonctionnalités standard + confort + commande vocale*

- › Amazon Alexa or Google Home/ Amazon Alexa oder Google Home/ Amazon Alexa ou Google Home

* Use a voice assistant with integrated bridge.

* Nutzen Sie einen Sprachassistenten mit integrierter Bridge.

* Utilisez un assistant vocal avec Bridge intégré.

You already have connect-c luminaires from the previous system! What now?

Sie besitzen bereits connect-c Leuchten des Vorgängersystems! Was nun?
Vous disposez déjà de luminaires connect-c de l'ancien système! Que faire ?

No problem! The previous connect-c products are compatible with the new connect.z system.
Kein Problem! Die bisherigen connect-c Produkte sind mit dem neuen connect.z System kompatibel.
Aucun problème! Les anciens produits connect-c sont compatibles avec le nouveau système connect.z.

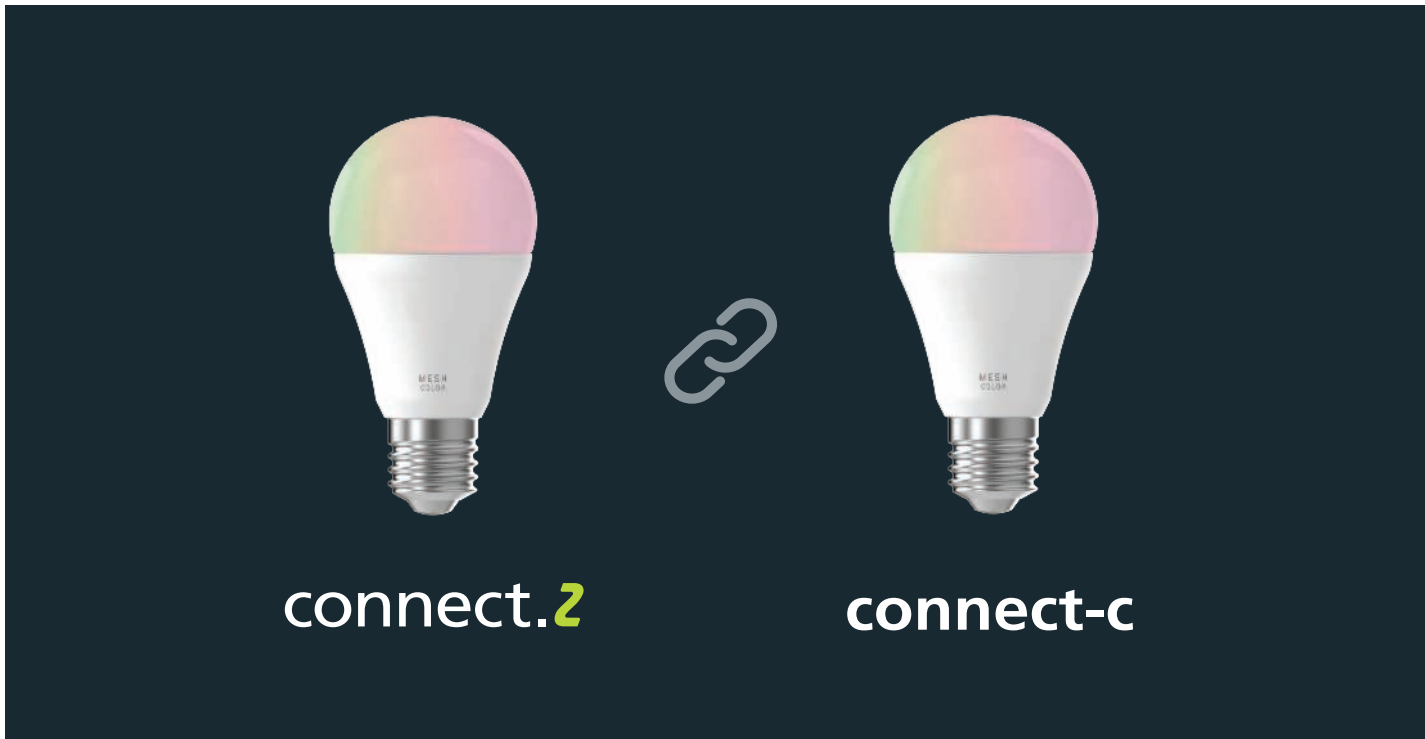

EGLO connect-c - connect.z

The existing EGLO connect-c system is compatible with the new EGLO connect.z system. You don't need to switch from the existing Bluetooth low energy system to the new open protocol ZigBee 3.0. Lights from EGLO connect-c can be incorporated into the existing EGLO connect.z system.

EGLO connect-c - connect.z

Das bestehende EGLO connect-c System ist mit dem neuen EGLO connect.z System kompatibel. Sie müssen nicht von dem bestehendem Bluetooth low energy System auf das neue offene Protokoll ZigBee 3.0 umsteigen. Leuchten von EGLO connect-c können in das bestehende EGLO connect.z System eingebunden werden.

EGLO connect-c - connect.z

Le système EGLO connect-c existant est compatible avec le nouveau système EGLO connect.z. Vous n'avez pas besoin de passer du système Bluetooth à basse consommation existant au nouveau protocole ouvert ZigBee 3.0. Les luminaires EGLO connect-c peuvent être intégrés au système EGLO connect.z existant.



99106



120°, 12 m
20 sec. - 10 min.

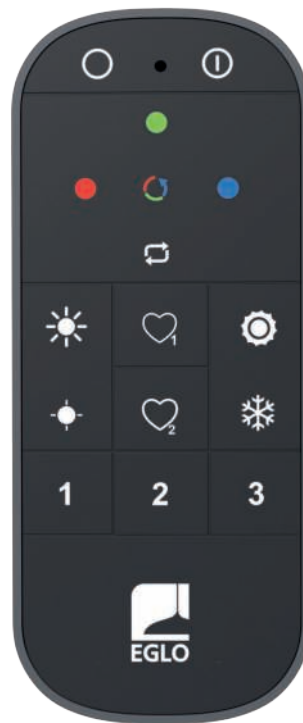

99099

99106 CONNECT-Z SENSOR

accessory; plastic, white
Zubehör; Kunststoff, weiss
accessoire; plastique, blanc

L 75, H 75, A 70



AA,
LR6 HP



2900mA,
1,5V



IP44



9 002759 991067



99099 CONNECT Z

remote control; plastic, grey
Fernbedienung; Kunststoff, grau
Télécommande; plastique, gris

L 122, B 54, H 18



AAA,
R03P



1,5V



9 002759 990992

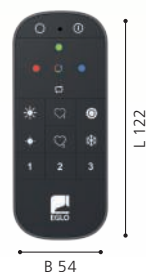



900387



900388



900387 ANCHORENA-Z

ceiling light; wood, steel, brown, black / plastic, white
Deckenleuchte; Holz, Stahl, braun, schwarz / Kunststoff, weiss
plafonnier; bois, acier, marron, noir / plastique, blanc

L 1230, B 80, H 110



35W



3980 lm



Remote,
App



9 008606 243662



900388 ANCHORENA-Z

pendant light; wood, steel, brown, black / plastic, white
Hängeleuchte; Holz, Stahl, braun, schwarz / Kunststoff, weiss
luminaire en suspension; bois, acier, marron, noir / plastique, blanc

L 1230, B 55, H 1100



35W



3980 lm



Remote,
App



9 008606 243679

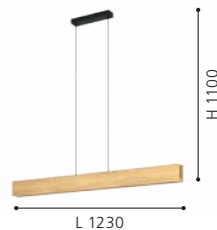

900391 ANCHORENA-Z

table light; wood, steel, brown, black / plastic, white
Tischleuchte; Holz, Stahl, braun, schwarz / Kunststoff, weiss
luminaire de table; bois, acier, marron, noir / plastique, blanc

L 75, B 55, H 465, Base: B 160, T 120



16W



1800 lm



Remote,
App



9 008606 243693





900391



900392 ANCHORENA-Z

floor light; wood, steel, brown, black / plastic, white
 Stehleuchte; Holz, Stahl, braun, schwarz / Kunststoff, weiss
 lampadaire; bois, acier, marron, noir / plastique, blanc

L 105, B 55, H 1500, Base: B 240, T 210



35W



3980lm



Remote,
App



900392





99679

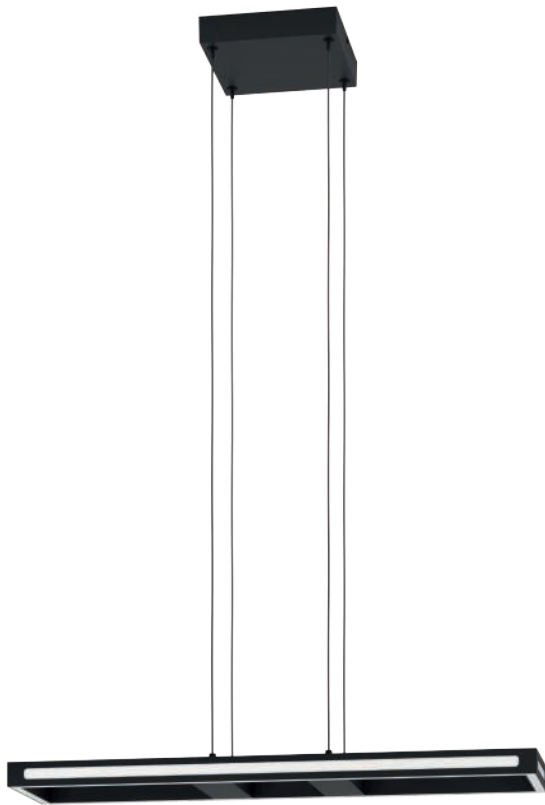

99678



99681



99679 SALVILANAS-Z

ceiling light; aluminium, steel, black / plastic, white
Deckenleuchte; Alu, Stahl, schwarz / Kunststoff, weiss
plafonnier; aluminium, acier, noir / plastique, blanc

L 770, B 200, H 75



21W 2700lm Remote, App



9 002759 996796



99678 SALVILANAS-Z

pendant light; aluminium, steel, black / plastic, white
Hängeleuchte; Alu, Stahl, schwarz / Kunststoff, weiss
luminaire en suspension; aluminium, acier, noir / plastique, blanc

L 770, B 200, H 1100



21W 2700lm Remote, App



9 002759 996789

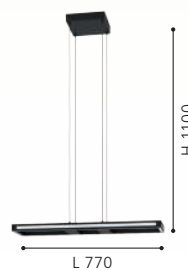

99681 SALVILANAS-Z

pendant light; aluminium, steel, black / plastic, white
Hängeleuchte; Alu, Stahl, schwarz / Kunststoff, weiss
luminaire en suspension; aluminium, acier, noir / plastique, blanc

L 1160, B 200, H 1100



33W 4300lm Remote, App



9 002759 996819

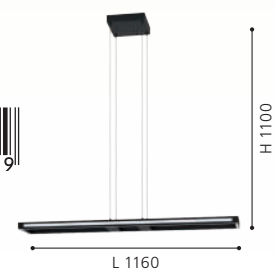



99682



99683



99682 SALVILANAS-Z

table light; aluminium, steel, black / plastic, white
 Tischleuchte; Alu, Stahl, schwarz / Kunststoff, weiss
 luminaire de table; aluminium, acier, noir / plastique, blanc

L 160, B 35, H 425, Base: B 240, T 160



9 002759 996826



99683 SALVILANAS-Z

floor light; aluminium, steel, black / plastic, white
 Stehleuchte; Alu, Stahl, schwarz / Kunststoff, weiss
 lampadaire; aluminium, acier, noir / plastique, blanc

L 200, B 35, H 1305, Base: B 280, T 180



9 002759 996833

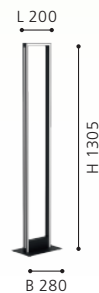

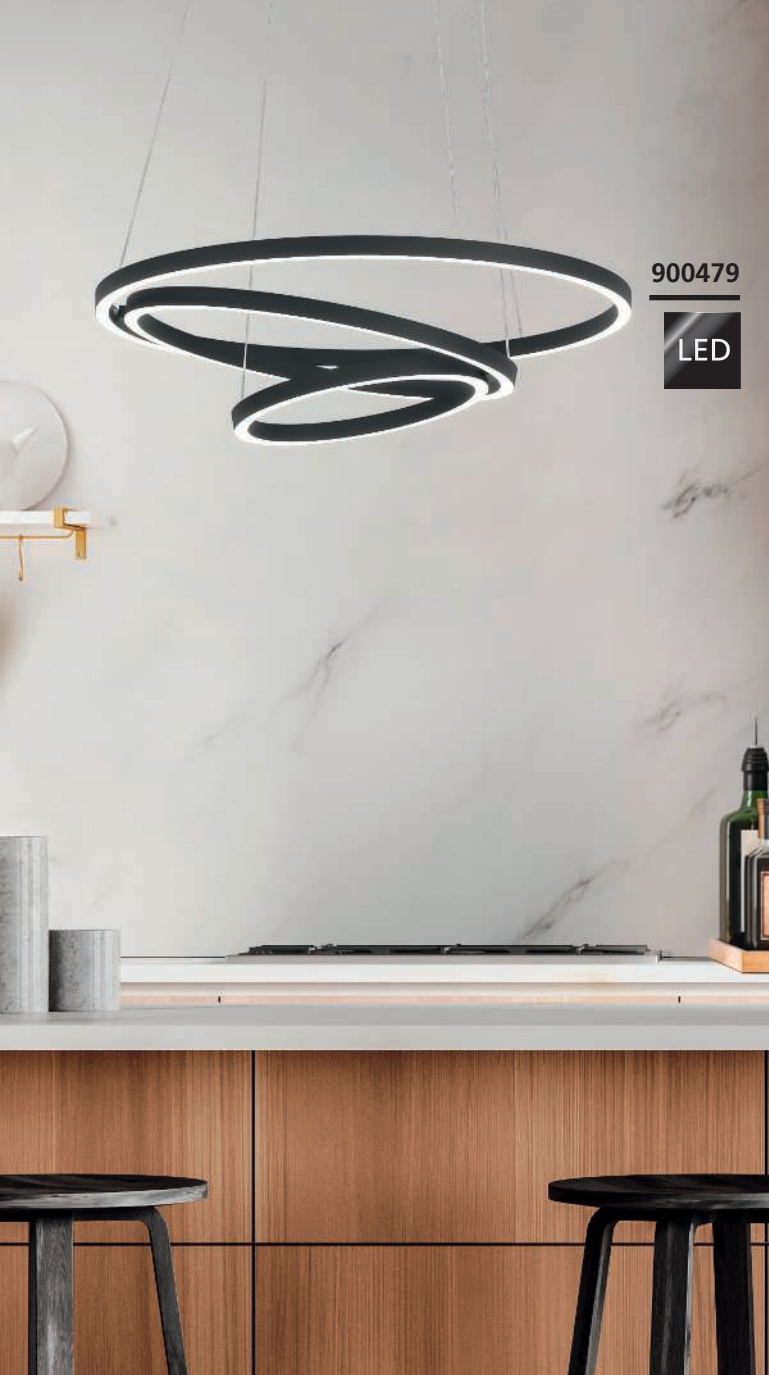

900479

LED



900478

LED

900479 LOBINERO-Z

pendant light; aluminium, steel, black / plastic, white
 Hängeleuchte; Alu, Stahl, schwarz / Kunststoff, weiss
 luminaire en suspension; aluminium, acier, noir / plastique, blanc

H 1100, Ø 580



43,2W 6000lm Remote, App



900478 LOBINERO-Z

pendant light; aluminium, steel, white / plastic, white
 Hängeleuchte; Alu, Stahl, weiss / Kunststoff, weiss
 luminaire en suspension; aluminium, acier, blanc / plastique, blanc

H 1100, Ø 580



43,2W 6000lm Remote, App



900398 ZILLERIO-Z

pendant light; steel, aluminium, black / plastic, white
 Hängeleuchte; Stahl, Alu, schwarz / Kunststoff, weiss
 luminaire en suspension; acier, aluminium, noir / plastique, blanc

L 1160, B 300, H 1100

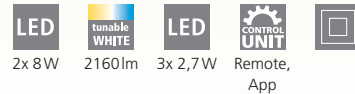

2x 8W 2160lm 3x 2,7W Remote, App

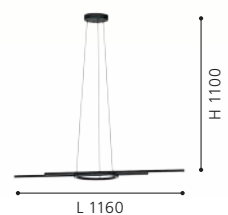



900398

LED

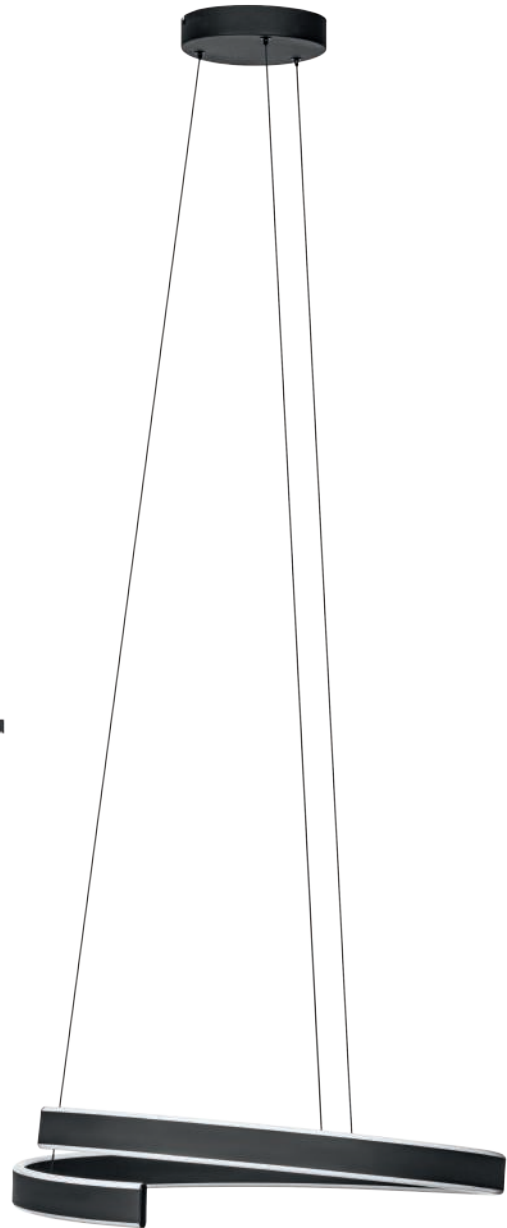

900404

LED

900404 ANDABAIA-Z

pendant light; aluminium, steel, black / plastic, white
 Hängeleuchte; Alu, Stahl, schwarz / Kunststoff, weiss
 luminaire en suspension; aluminium, acier, noir / plastique, blanc

H 1540, Ø 600

LED

42,5W

tunable
WHITE

5300lm

CONTROL
UNIT

Remote,
App

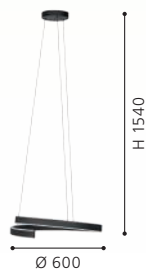



900336

LED



900337

LED



900338

LED



900336 TELIMBELA-Z

spot; steel, black
Spot; Stahl, schwarz
spot; acier, noir

H 97, Ø 250



GU10



3x 4,9W



3x 345lm



Remote, App



900337 TELIMBELA-Z

spot; steel, black
Spot; Stahl, schwarz
spot; acier, noir

L 580, B 80, H 97



GU10



4x 4,9W



4x 345lm



Remote, App



900338 TELIMBELA-Z

spot; steel, white
Spot; Stahl, weiss
spot; acier, blanc

H 97, Ø 250



GU10



3x 4,9W



3x 345lm



Remote, App



9 008606 239948



9 008606 239955



9 008606 239962





900339

LED

900339 TELIMBELA-Z

spot; steel, white
Spot; Stahl, weiss
spot; acier, blanc

L 580, B 80, H 97



GU10



4x 4,9W



4x
345 lm



Remote,
App



9 008606 239979



INCL.





900407

LED



900406

LED



DIMMABLE
VIA REMOTE
AND APP

900407 TOLLOS-Z

ceiling light; aluminium, steel, black, white / plastic, white
Deckenleuchte; Alu, Stahl, schwarz, weiss / Kunststoff, weiss
plafonnier; aluminium, acier, noir, blanc / plastique, blanc

H 130, Ø 550



3x 11 W



3750 lm



Remote,
App



9 008606 243808



900406 TOLLOS-Z

ceiling light; aluminium, steel, black, white / plastic, white
Deckenleuchte; Alu, Stahl, schwarz, weiss / Kunststoff, weiss
plafonnier; aluminium, acier, noir, blanc / plastique, blanc

H 130, Ø 400



3x 7,5 W



2700 lm



Remote,
App



9 008606 243792



900439 ROMAO-Z

ceiling light; steel, white / fabric, plastic, white
Deckenleuchte; Stahl, weiss / Textil, Kunststoff, weiss
plafonnier; acier, blanc / tissu, plastique, blanc

H 150, Ø 570



35 W



3500 lm



Remote,
App



9 008606 243914





900439



900441



900442



900441 ROMAO-Z

ceiling light; steel, white / fabric, plastic, taupe, white
 Deckenleuchte; Stahl, weiss / Textil, Kunststoff, taupe, weiss
 plafonnier; acier, blanc / tissu, plastique, taupe, blanc

H 150, Ø 570

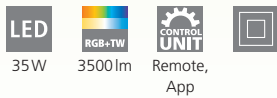

900442 ROMAO-Z

ceiling light; steel, white / fabric linen, plastic, grey, white
 Deckenleuchte; Stahl, weiss / Textil Leinen, Kunststoff, grau, weiss
 plafonnier; acier, blanc / tissu de lin, plastique, gris, blanc

H 150, Ø 570

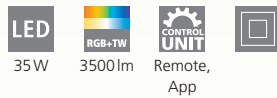

9 008606 243921

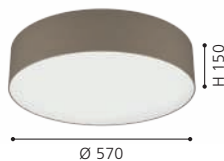

9 008606 243938





900408



900409



900411



900408 MONTEMORELOS-Z

ceiling light; aluminium, white / plastic with crystal effect, white
Deckenleuchte; Alu, weiss / Kunststoff m. Kristalleffekt, weiss
plafonnier; aluminium, blanc / plastique avec effet cristal, blanc

H 50, Ø 420



17,8W



2150lm



Remote,
App



9 008606 243815

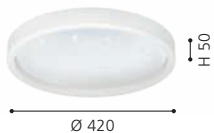

Ø 420

900409 MONTEMORELOS-Z

ceiling light; aluminium, white / plastic with crystal effect, white
Deckenleuchte; Alu, weiss / Kunststoff m. Kristalleffekt, weiss
plafonnier; aluminium, blanc / plastique avec effet cristal, blanc

H 70, Ø 570



34,5W



4100lm



Remote,
App



9 008606 243822



Ø 570

900411 MONTEMORELOS-Z

ceiling light; aluminium, black / plastic with crystal effect, white
Deckenleuchte; Alu, schwarz / Kunststoff m. Kristalleffekt, weiss
plafonnier; aluminium, noir / plastique avec effet cristal, blanc

H 50, Ø 420



17,8W



2150lm



Remote,
App



9 008606 243839



Ø 420



900412



900636

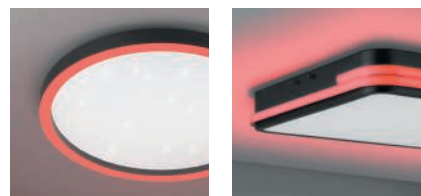

MONTEMORELOS-Z, GENOVESE-Z

The frame of these luminaires can switch between the RGB colors, the inner part can reproduce different white tones between 2700K and 6500K. By controlling via app or remote control, individual lighting effects can be set.

Der Rahmen dieser Leuchten kann zwischen den RGB Farbtönen wechseln, der Innenteil kann verschiedene Weißtöne zwischen 2700K und 6500K wiedergeben. Durch Steuerung per App oder Fernbedienung können so individuelle Lichtspiele eingestellt werden.

Le cadre de cette luminaires peut basculer entre les couleurs RVB, la partie intérieure peut reproduire différents tons blancs entre 2700K et 6500K. En contrôlant via l'application ou la télécommande, des effets d'éclairage individuels peuvent être définis.



900477



900412 MONTEMORELOS-Z

ceiling light; aluminium, black / plastic with crystal effect, white
Deckenleuchte; Alu, schwarz / Kunststoff m. Kristalleffekt, weiss
plafonnier; aluminium, noir / plastique avec effet cristal, blanc

H 70, Ø 570

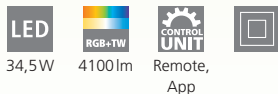

34,5W 4100lm Remote, App



9 008606 243846



900636 TOTARI-Z

ceiling light; steel, white / plastic with crystal effect, white
Deckenleuchte; Stahl, weiss / Kunststoff m. Kristalleffekt, weiss
plafonnier; acier, blanc / plastique avec effet cristal, blanc

H 70, Ø 380

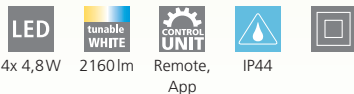

4x 4,8W 2160lm Remote, App IP44



9 008606 245208

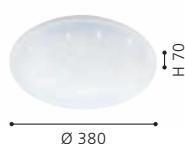

900477 GENOVESE-Z

ceiling light; aluminium, steel, black / plastic, white
Deckenleuchte; Alu, Stahl, schwarz / Kunststoff, weiss
plafonnier; aluminium, acier, noir / plastique, blanc

L 470, B 470, H 70

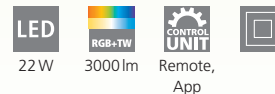

22W 3000lm Remote, App



9 008606 252763

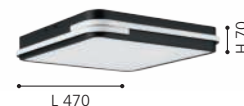



900322



900323



900324



900322 PARRAPOS-Z

ceiling light; steel, black / plastic, white
Deckenleuchte; Stahl, schwarz / Kunststoff, weiss
plafonnier; acier, noir / plastique, blanc

L 445, B 300, H 70



900323 PARRAPOS-Z

ceiling light; steel, black / plastic, white
Deckenleuchte; Stahl, schwarz / Kunststoff, weiss
plafonnier; acier, noir / plastique, blanc

L 340, B 300, H 45



900324 PARRAPOS-Z

wall light; steel, black / plastic, white
Wandleuchte; Stahl, schwarz / Kunststoff, weiss
applique; acier, noir / plastique, blanc

L 200, H 240, A 50



9 008606 231256



9 008606 231263



9 008606 231270





900319



900321



900319 PARRAPOS-Z

ceiling light; steel, black / plastic, white
 Deckenleuchte; Stahl, schwarz / Kunststoff, weiss
 plafonnier; acier, noir / plastique, blanc

L 615, B 450, H 80



900321 PARRAPOS-Z

ceiling light; steel, black / plastic, white
 Deckenleuchte; Stahl, schwarz / Kunststoff, weiss
 plafonnier; acier, noir / plastique, blanc

L 545, B 445, H 90

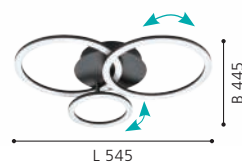
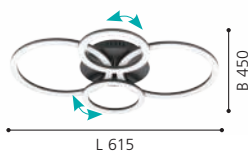

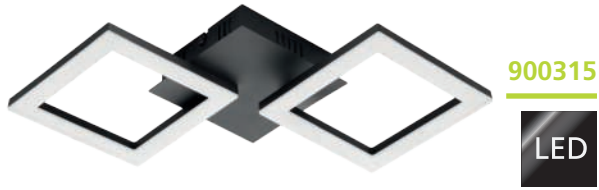

900315

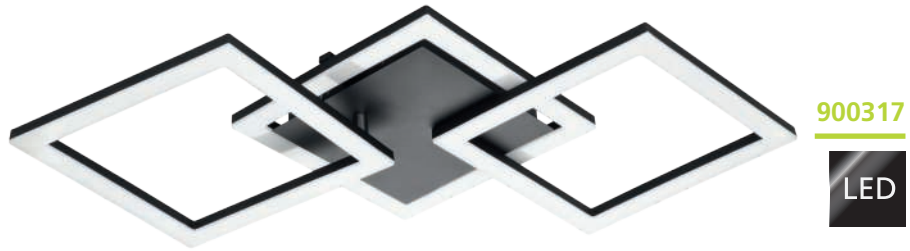

900317

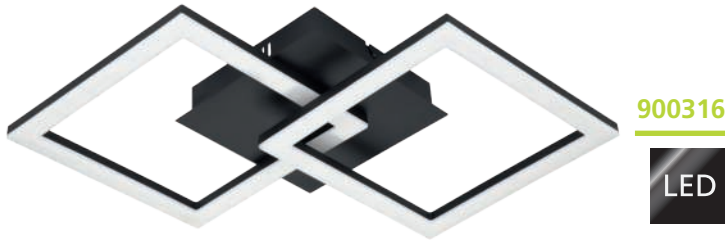

900316



900315 PARANDAY-Z

ceiling light; steel, black / plastic, white
Deckenleuchte; Stahl, schwarz / Kunststoff, weiss
plafonnier; acier, noir / plastique, blanc

L 470, B 225, H 60



15,5W 1800lm Remote, App

900316 PARANDAY-Z

ceiling light; steel, black / plastic, white
Deckenleuchte; Stahl, schwarz / Kunststoff, weiss
plafonnier; acier, noir / plastique, blanc

L 525, B 310, H 60



21,5W 2500lm Remote, App

900317 PARANDAY-Z

ceiling light; steel, black / plastic, white
Deckenleuchte; Stahl, schwarz / Kunststoff, weiss
plafonnier; acier, noir / plastique, blanc

L 650, B 310, H 60



32,4W 4000lm Remote, App



9 008606 231195

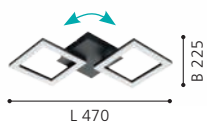

9 008606 231201

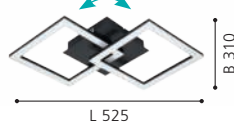

9 008606 231218

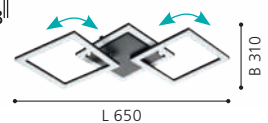



900318



900566

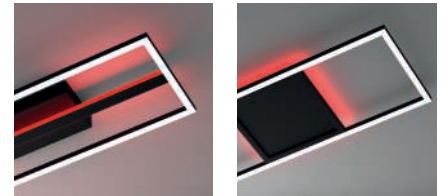

900567



CALAGRANO-Z

These lights have individually controllable light settings on the inside and outside of the frame.

Diese Leuchten verfügen über individuell steuerbare Lichteinstellungen der Rahmen innen und außen.

Ces lumières ont des paramètres d'éclairage contrôlables individuellement du cadre.

900318 PARANDAY-Z

ceiling light; steel, black / plastic, white
Deckenleuchte; Stahl, schwarz / Kunststoff, weiss
plafonnier; acier, noir / plastique, blanc

L 470, B 430, H 65



9 008606 231225



900566 CALAGRANO-Z

ceiling light; aluminium, steel, black / plastic, white
Deckenleuchte; Alu, Stahl, schwarz / Kunststoff, weiss
plafonnier; aluminium, acier, noir / plastique, blanc

L 640, B 240, H 45



9 008606 244683

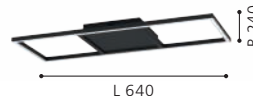

900567 CALAGRANO-Z

ceiling light; aluminium, steel, black / plastic, white
Deckenleuchte; Alu, Stahl, schwarz / Kunststoff, weiss
plafonnier; aluminium, acier, noir / plastique, blanc

L 640, B 220, H 50



9 008606 244690





900481



900484



900483



900481 PADROGIANO-Z

ceiling light; steel, white / plastic, white
Deckenleuchte; Stahl, weiss / Kunststoff, weiss
plafonnier; acier, blanc / plastique, blanc

L 450, B 450, H 50

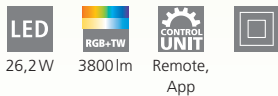

26,2W 3800lm Remote, App

900483 PADROGIANO-Z

ceiling light; steel, white / plastic, white
Deckenleuchte; Stahl, weiss / Kunststoff, weiss
plafonnier; acier, blanc / plastique, blanc

L 450, B 450, H 50



27,9W 3600lm Remote, App

900484 PADROGIANO-Z

ceiling light; steel, white / plastic, white
Deckenleuchte; Stahl, weiss / Kunststoff, weiss
plafonnier; acier, blanc / plastique, blanc

L 595, B 595, H 50

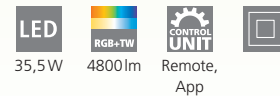

35,5W 4800lm Remote, App



9 008606 244164

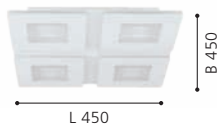

9 008606 244188



9 008606 244195





900486

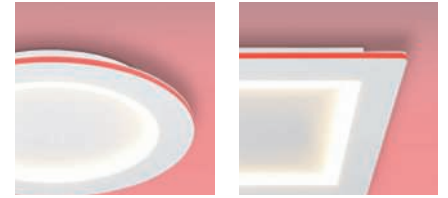

PADROGIANO-Z

These lights have individually controllable light settings on the inside and outside of the frame.

Diese Leuchten verfügen über individuell steuerbare Lichteinstellungen der Rahmen innen und außen.

Ces lumières ont des paramètres d'éclairage contrôlables individuellement du cadre.



900487



900486 PADROGIANO-Z

ceiling light; steel, white / plastic, white
Deckenleuchte; Stahl, weiss / Kunststoff, weiss
plafonnier; acier, blanc / plastique, blanc

H 50, Ø 450

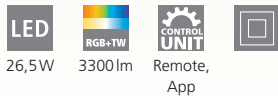

26,5W

3300lm

Remote,
App



9 008606 244218



900487 PADROGIANO-Z

ceiling light; steel, white / plastic, white
Deckenleuchte; Stahl, weiss / Kunststoff, weiss
plafonnier; acier, blanc / plastique, blanc

H 50, Ø 595



35W

4600lm

Remote,
App



9 008606 244225





900482



PADROGIANO-Z

The frame of these luminaires can switch between the RGB colors, the inner part can reproduce different white tones between 2700K and 6500K. By controlling via app or remote control, individual lighting effects can be set.

Der Rahmen dieser Leuchten kann zwischen den RGB Farbtönen wechseln, der Innenteil kann verschiedene Weißtöne zwischen 2700K und 6500K wiedergeben. Durch Steuerung per App oder Fernbedienung können so individuelle Lichtspiele eingestellt werden.

Le cadre de cette luminaires peut basculer entre les couleurs RVB, la partie intérieure peut reproduire différents tons blancs entre 2700K et 6500K.

En contrôlant via l'application ou la télécommande, des effets d'éclairage individuels peuvent être définis.



900482 PADROGIANO-Z

ceiling light; steel, white / plastic, white
Deckenleuchte; Stahl, weiss / Kunststoff, weiss
plafonnier; acier, blanc / plastique, blanc

L 1200, B 300, H 50



42,5 W 6000 lm Remote, App



9 008606 244171



900485 PADROGIANO-Z

ceiling light; steel, white / plastic, white
Deckenleuchte; Stahl, weiss / Kunststoff, weiss
plafonnier; acier, blanc / plastique, blanc

L 1200, B 300, H 50

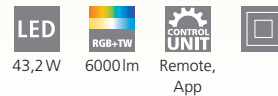

43,2 W 6000 lm Remote, App



9 008606 244201

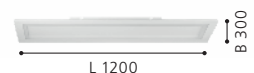

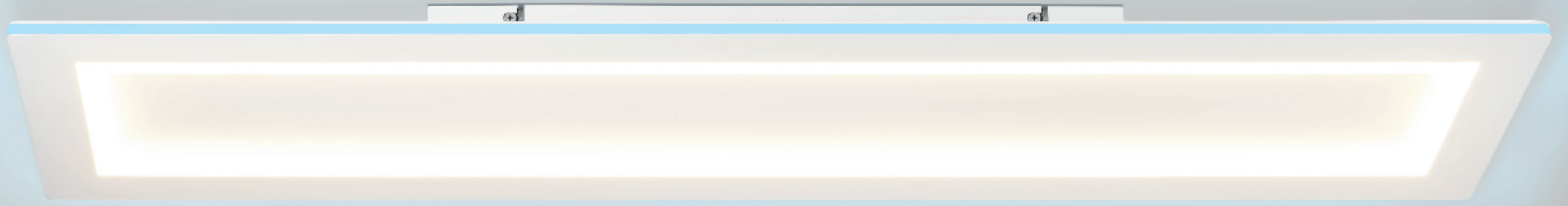

900485

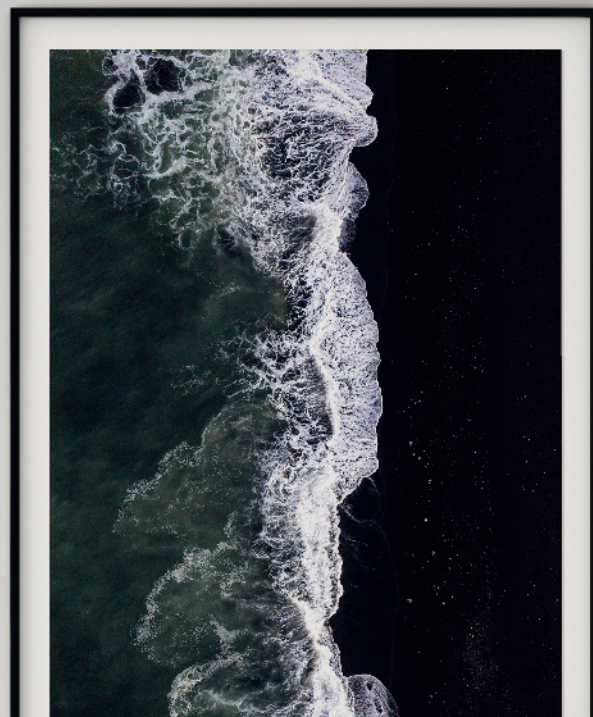



900075 VALDELAGRANO-Z

pendant light; steel, wood, black / fabric, white
 Hängeleuchte; Stahl, Holz, schwarz / Textil, weiss
 luminaire en suspension; acier, bois, noir / tissu, blanc

L 1000, B 105, H 1100

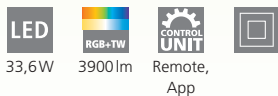

99603 SIMOLARIS-Z

pendant light; aluminium, steel, black / plastic, white
 Hängeleuchte; Alu, Stahl, schwarz / Kunststoff, weiss
 luminaire en suspension; aluminium, acier, noir / plastique, blanc

L 1220, B 55, H 1100

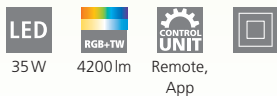

99601 SIMOLARIS-Z

ceiling light; aluminium, steel, black / plastic, white
 Deckenleuchte; Alu, Stahl, schwarz / Kunststoff, weiss
 plafonnier; aluminium, acier, noir / plastique, blanc

L 470, B 55, H 110





99602

LED



99604

LED

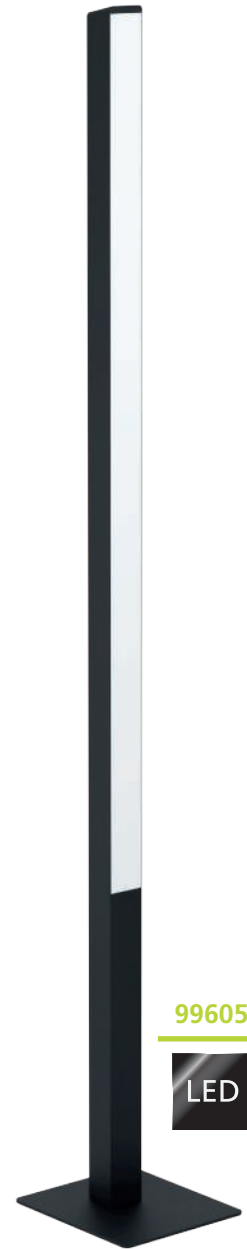

99605

LED

99602 SIMOLARIS-Z

ceiling light; aluminium, steel, black / plastic, white
Deckenleuchte; Alu, Stahl, schwarz / Kunststoff, weiss
plafonnier; aluminium, acier, noir / plastique, blanc

L 1220, B 55, H 110



35W 4200lm Remote, App



9 002759 996024

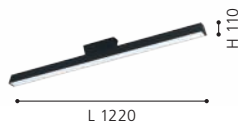

99604 SIMOLARIS-Z

table light; aluminium, steel, black / plastic, white
Tischleuchte; Alu, Stahl, schwarz / Kunststoff, weiss
luminaire de table; aluminium, acier, noir / plastique, blanc

L 55, B 55, H 515, Base: B 160, T 120



16W 1900lm Remote, App



9 002759 996048



99605 SIMOLARIS-Z

floor light; aluminium, steel, black / plastic, white
Stehleuchte; Alu, Stahl, schwarz / Kunststoff, weiss
lampadaire; aluminium, acier, noir / plastique, blanc

L 55, B 55, H 1615, Base: B 240, T 210



35W 4200lm Remote, App



9 002759 996055

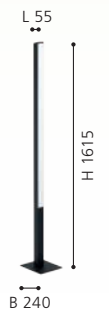

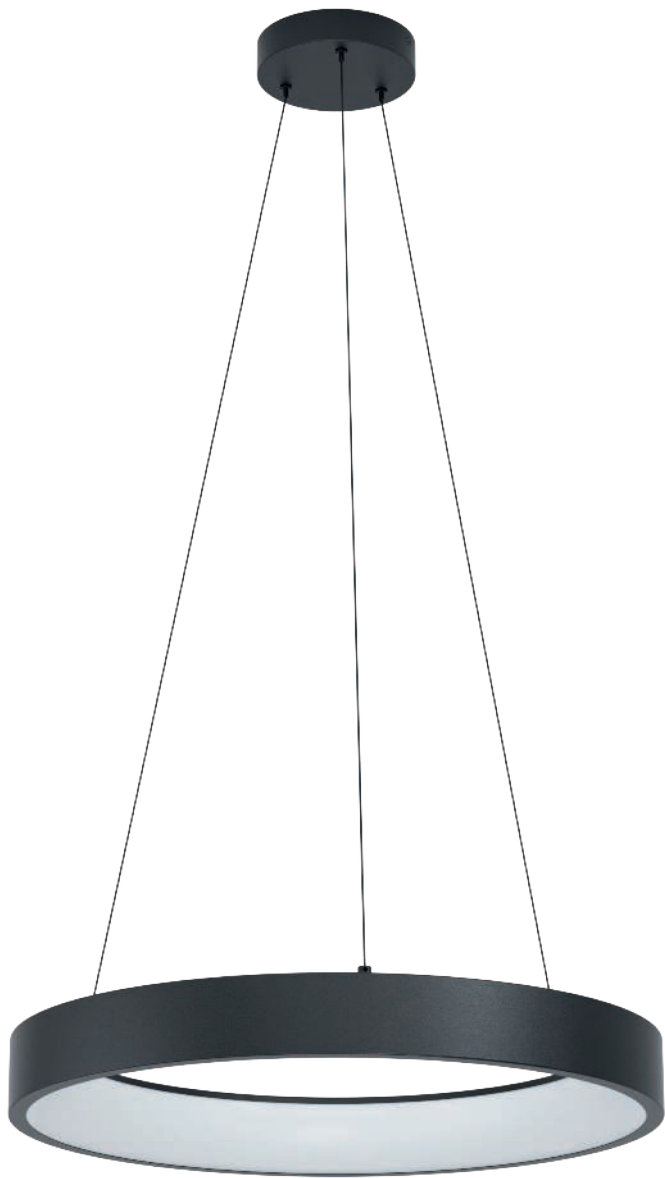

900068



900067



900069



900068 MARGHERA-Z

pendant light; steel, black / plastic, white
 Hängeleuchte; Stahl, schwarz / Kunststoff, weiss
 luminaire en suspension; acier, noir / plastique, blanc

H 1100, Ø 600



4x 6,5W



3120lm



Remote,
App

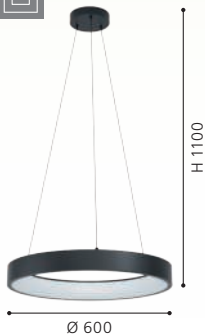

9 008606 222032

900067 MARGHERA-Z

ceiling light; steel, black / plastic, white
 Deckenleuchte; Stahl, schwarz / Kunststoff, weiss
 plafonnier; acier, noir / plastique, blanc

H 110, Ø 600



4x 6,5W



3120lm



Remote,
App



9 008606 222025



900069 MARGHERA-Z

wall light; steel, black / plastic, white
 Wandleuchte; Stahl, schwarz / Kunststoff, weiss
 applique; acier, noir / plastique, blanc

L 270, H 305, A 200



4x 4W



1800lm



Remote,
App



9 008606 222049





900071



900072



900071 MARGHERA-Z

table light; steel, black / plastic, white
Tischleuchte; Stahl, schwarz / Kunststoff, weiss
luminaire de table; acier, noir / plastique, blanc

L 270, H 265, Base: Ø 145



900072 MARGHERA-Z

floor light; steel, black / plastic, white
Stehleuchte; Stahl, schwarz / Kunststoff, weiss
lampadaire; acier, noir / plastique, blanc

L 270, B 305, H 1690, Base: Ø 305

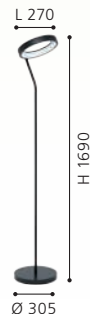



99673

LED



99674

LED



99675

LED



99673 CAMINALES-Z

ceiling light; steel, black
Deckenleuchte; Stahl, schwarz
plafonnier; acier, noir

L 125, B 125, H 120



GU10



1x 5W



1x
345lm



Remote,
App



99674 CAMINALES-Z

ceiling light; steel, black
Deckenleuchte; Stahl, schwarz
plafonnier; acier, noir

L 240, B 125, H 120



GU10



2x 5W



2x
345lm



Remote,
App



99675 CAMINALES-Z

ceiling light; steel, black
Deckenleuchte; Stahl, schwarz
plafonnier; acier, noir

L 240, B 240, H 120



GU10



4x 5W



4x
345lm



Remote,
App

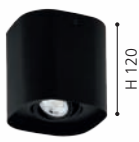



99669

LED



DESIGN
HIGHLIGHT
DETAIL



99671

LED



99672

LED

99669 SALICETO-Z

recessed light; aluminium, black
Einbauleuchte; Alu, schwarz
luminaire encastrable; aluminium, noir

H 46, Ø 88, ET 50

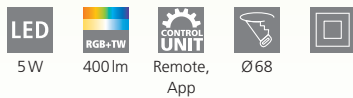

99671 SALICETO-Z

recessed light; aluminium, white
Einbauleuchte; Alu, weiss
luminaire encastrable; aluminium, blanc

H 46, Ø 88, ET 50

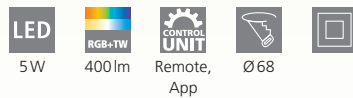

99672 SALICETO-Z

recessed light; aluminium, satin nickel
Einbauleuchte; Alu, nickel-matt
luminaire encastrable; aluminium, nickel mat

H 46, Ø 88, ET 50

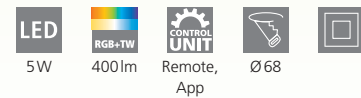



99677

LED



99676

LED

DIMMABLE
VIA REMOTE
AND APP



99677 LOMALTAS-Z

ceiling light; steel, wood, black, brown / plastic, white
Deckenleuchte; Stahl, Holz, schwarz, braun / Kunststoff, weiss
plafonnier; acier, bois, noir, marron / plastique, blanc

L 770, B 495, H 85



4x 8W



4400lm



Remote,
App



99676 LOMALTAS-Z

ceiling light; steel, wood, black, brown / plastic, white
Deckenleuchte; Stahl, Holz, schwarz, braun / Kunststoff, weiss
plafonnier; acier, bois, noir, marron / plastique, blanc

L 580, B 350



4x 8W



4400lm



Remote,
App



9 002759 996772

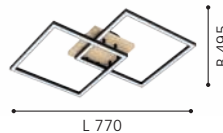

9 002759 996765





900019

LED



900021

LED



99588

LED

900019 TABIANO-Z

mirror light; steel, chrome / plastic, white
Spiegelleuchte; Stahl, chrom / Kunststoff, weiss
applique pour miroir; acier, chrome / plastique, blanc

L 605, H 70, A 135

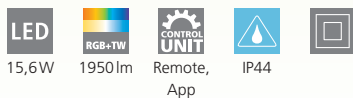

15,6W

1950lm

Remote,
App

IP44

900021 TABIANO-Z

mirror light; steel, chrome / plastic, white
Spiegelleuchte; Stahl, chrom / Kunststoff, weiss
applique pour miroir; acier, chrome / plastique, blanc

L 905, H 70, A 135

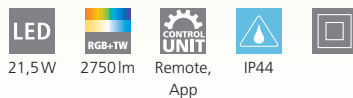

21,5W

2750lm

Remote,
App

IP44

99588 JUAREZA-Z

mirror light; steel, white / mirror
Spiegelleuchte; Stahl, weiss / Spiegel
applique pour miroir; acier, blanc / miroir

L 700, H 500, A 55



20W

2300lm

Remote,
App

IP44



9 008606 221646

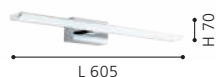

9 008606 221653



9 002759 995881



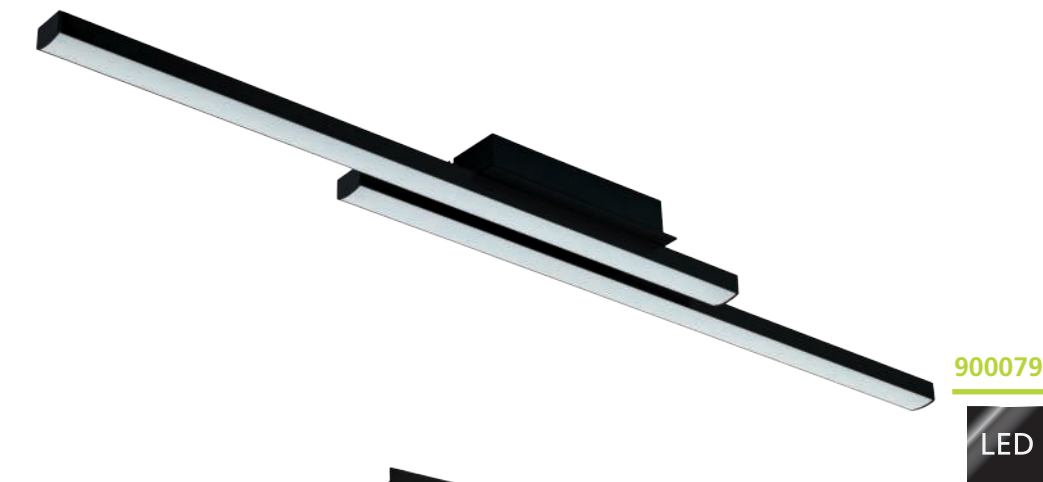

900079



900081

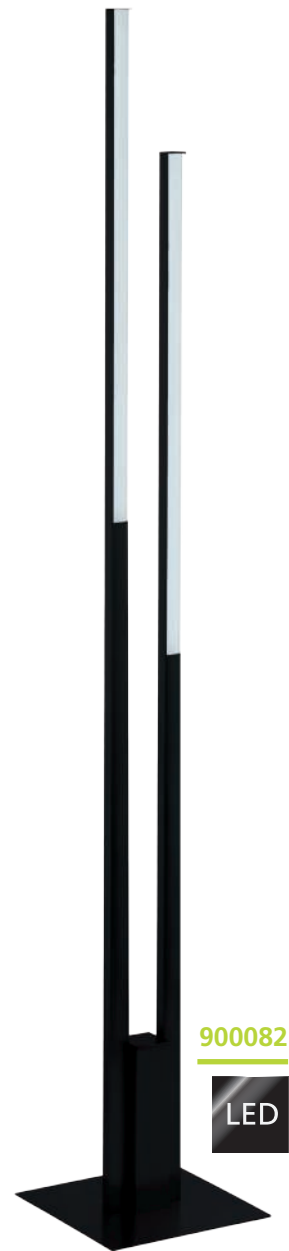

900082



900079 FRAIOLI-Z

ceiling light; aluminium, black / plastic, white
Deckenleuchte; Alu, schwarz / Kunststoff, weiss
plafonnier; aluminium, noir / plastique, blanc

L 1055, B 120, H 65



2x 17W 4800lm Remote, App



9 008606 223565



900081 FRAIOLI-Z

pendant light; aluminium, black / plastic, white
Hängeleuchte; Alu, schwarz / Kunststoff, weiss
luminaire en suspension; aluminium, noir / plastique, blanc

L 1055, B 100, H 1200

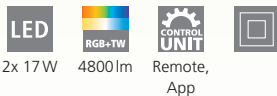

2x 17W 4800lm Remote, App



9 008606 223572



900082 FRAIOLI-Z

floor light; aluminium, black / plastic, white
Stehleuchte; Alu, schwarz / Kunststoff, weiss
lampadaire; aluminium, noir / plastique, blanc

H 1755, Base: B 280, T 280



2x 17W 4800lm Remote, App



9 008606 223589





900076



900077



900078



900076 FRAIOLI-Z

ceiling light; aluminium, satin nickel / plastic, white
Deckenleuchte; Alu, nickel-matt / Kunststoff, weiss
plafonnier; aluminium, nickel mat / plastique, blanc

L 1055, B 120, H 65



2x 17W 4800lm Remote, App



9 008606 223534



900077 FRAIOLI-Z

pendant light; aluminium, satin nickel / plastic, white
Hängeleuchte; Alu, nickel-matt / Kunststoff, weiss
luminaire en suspension; aluminium, nickel mat / plastique, blanc

L 1055, B 100, H 1200



2x 17W 4800lm Remote, App



9 008606 223541



900078 FRAIOLI-Z

floor light; aluminium, satin nickel / plastic, white
Stehleuchte; Alu, nickel-matt / Kunststoff, weiss
lampadaire; aluminium, nickel mat / plastique, blanc

H 1755, Base: B 280, T 280



2x 17W 4800lm

Remote, App



9 008606 223558





900001



900002



900084



900001 TOTARI-Z

ceiling light; steel, white / plastic with crystal effect, white
Deckenleuchte; Stahl, weiss / Kunststoff m. Kristalleffekt, weiss
plafonnier; acier, blanc / plastique avec effet cristal, blanc

H 70, Ø 380



900002 TOTARI-Z

ceiling light; steel, white / plastic with crystal effect, white
Deckenleuchte; Stahl, weiss / Kunststoff m. Kristalleffekt, weiss
plafonnier; acier, blanc / plastique avec effet cristal, blanc

H 70, Ø 530

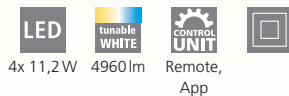

900084 TOTARI-Z

ceiling light; steel, white / plastic, white
Deckenleuchte; Stahl, weiss / Kunststoff, weiss
plafonnier; acier, blanc / plastique, blanc

H 70, Ø 380



9 008606 221479

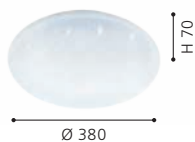

9 008606 221486

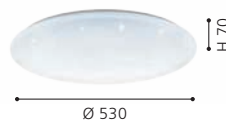

9 008606 225453

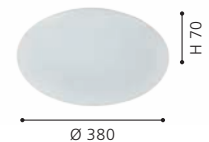

900085

LED



900085 TOTARI-Z

ceiling light; steel, white / plastic, white
Deckenleuchte; Stahl, weiss / Kunststoff, weiss
plafonnier; acier, blanc / plastique, blanc

H 70, Ø 530



4x 11,2W



4960lm



Remote,
App



9 008606 225460





900083



900005



900006



900083 LANCIANO-Z

ceiling light; steel, white, transparent / plastic with crystal effect, white, chrome

Deckenleuchte; Stahl, weiss, transparent / Kunststoff m.Kristalleffekt, weiss, chrom

plafonnier; acier, blanc, transparent / plastique avec effet cristal, blanc, chrome
H 80, Ø 450



4x 4,8W

2160lm

Remote,
App

900005 LANCIANO-Z

ceiling light; steel, white, transparent / plastic with crystal effect, white, chrome

Deckenleuchte; Stahl, weiss, transparent / Kunststoff m.Kristalleffekt, weiss, chrom

plafonnier; acier, blanc, transparent / plastique avec effet cristal, blanc, chrome
H 80, Ø 560



4x 11,2W

4960lm

Remote,
App

900006 LANCIANO-Z

ceiling light; steel, white, transparent / plastic with crystal effect, white, chrome

Deckenleuchte; Stahl, weiss, transparent / Kunststoff m.Kristalleffekt, weiss, chrom

plafonnier; acier, blanc, transparent / plastique avec effet cristal, blanc, chrome
H 95, Ø 770



38,1W

5350lm

Remote,
App



9 008606 225446

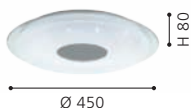

9 008606 221516

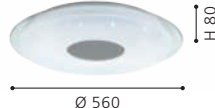

9 008606 221523





900008

LED



900128

LED



900129

LED

900008 CAPASSO-Z

wall / ceiling light; steel, white / plastic, white, chrome
Wand- / Deckenleuchte; Stahl, weiss / Kunststoff, weiss, chrom
applique / plafonnier; acier, blanc / plastique, blanc, chrome

H 70, Ø 340



4x 3,9W 1880lm Remote, App

900128 SILERAS-Z

ceiling light; steel, white / plastic with crystal effect, white
Deckenleuchte; Stahl, weiss / Kunststoff m.Kristalleffekt, weiss
plafonnier; acier, blanc / plastique avec effet cristal, blanc

H 60, Ø 430



3x 7,2W 2700lm Remote, App

900129 SILERAS-Z

ceiling light; steel, white / plastic with crystal effect, white
Deckenleuchte; Stahl, weiss / Kunststoff m.Kristalleffekt, weiss
plafonnier; acier, blanc / plastique avec effet cristal, blanc

H 60, Ø 600

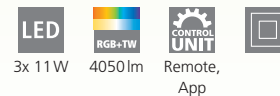

3x 11W 4050lm Remote, App



9 008606 221547

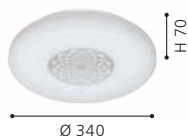

9 008606 226054



9 008606 226061

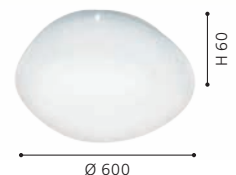



900025

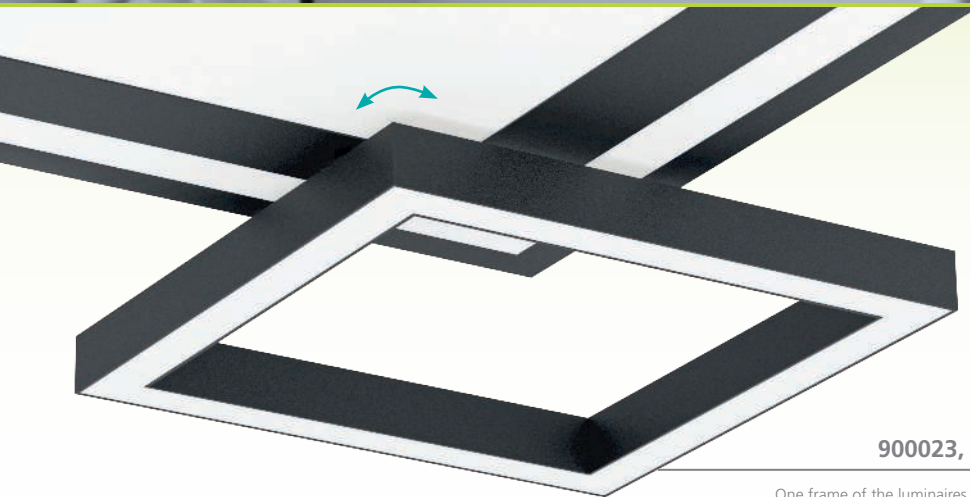

900023, 900025

One frame of the luminaires is rotatable.

Ein Rahmen der Leuchten ist drehbar.

Un cadre de les luminaires est rotatif.

900025 SAVATARILA-Z

ceiling light; steel, black / plastic, white
 Deckenleuchte; Stahl, schwarz / Kunststoff, weiss
 plafonnier; acier, noir / plastique, blanc

L 450, B 450, H 70



4x 2,7W



1320lm



4x 2,7W



Remote,
App



9 008606 221691

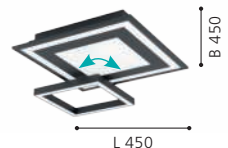



900022



900024



900023



900023 SAVATARILA-Z

ceiling light; steel, white / plastic, white
Deckenleuchte; Stahl, weiss / Kunststoff, weiss
plafonnier; acier, blanc / plastique, blanc

L 450, B 450, H 70

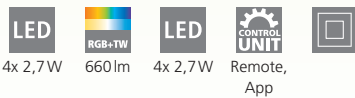

900022 SALITERAS-Z

ceiling light; steel, white / plastic, white
Deckenleuchte; Stahl, weiss / Kunststoff, weiss
plafonnier; acier, blanc / plastique, blanc

L 1160, B 160, H 50



900024 SALITERAS-Z

ceiling light; steel, black / plastic, white
Deckenleuchte; Stahl, schwarz / Kunststoff, weiss
plafonnier; acier, noir / plastique, blanc

L 1160, B 160, H 50



9 008606 221677

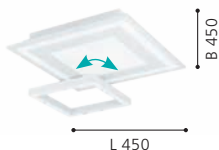

9 008606 221660



9 008606 221684





900054



900056



TURCONA-Z

Frameless luminaire

Rahmenlose Leuchte

Luminaire sans cadre



900054 TURCONA-Z

ceiling light; steel, aluminium, white / plastic, white
Deckenleuchte; Stahl, Alu, weiss / Kunststoff, weiss
plafonnier; acier, aluminium, blanc / plastique, blanc

H 60, Ø 300



15,7W



1730lm



Remote,

App



900056 TURCONA-Z

ceiling light; steel, aluminium, white / plastic, white
Deckenleuchte; Stahl, Alu, weiss / Kunststoff, weiss
plafonnier; acier, aluminium, blanc / plastique, blanc

H 75, Ø 600



34,2W



3980lm



Remote,

App



900055 TURCONA-Z

ceiling light; steel, aluminium, white / plastic, white
Deckenleuchte; Stahl, Alu, weiss / Kunststoff, weiss
plafonnier; acier, aluminium, blanc / plastique, blanc

H 75, Ø 450



22,4W



2490lm



Remote,

App



9 008606 221905



9 008606 221929

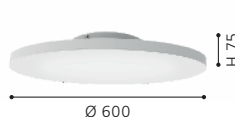

9 008606 221912





900055

LED

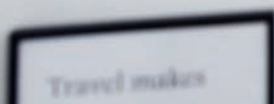



99548



99549



99548 HERRORA-Z

ceiling light; aluminium, white / plastic, white
Deckenleuchte; Alu, weiss / Kunststoff, weiss
plafonnier; aluminium, blanc / plastique, blanc

L 595, B 595, H 40



6x 5,3W 4500lm Remote, App



9 002759 995485

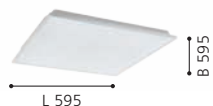

99549 HERRORA-Z

ceiling light; aluminium, white / plastic, white
Deckenleuchte; Alu, weiss / Kunststoff, weiss
plafonnier; aluminium, blanc / plastique, blanc

L 1200, B 300, H 40



3x 10,5W 4500lm Remote, App



9 002759 995492



99639 HERRORA-Z

ceiling light; aluminium, white / plastic, white
Deckenleuchte; Alu, weiss / Kunststoff, weiss
plafonnier; aluminium, blanc / plastique, blanc

L 450, B 450, H 40



22W 2900lm Remote, App



9 002759 996390

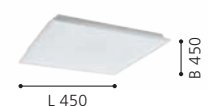



99639





900057
LED

900058
LED



900059
LED

TURCONA-Z

Frameless luminaire
Rahmenlose Leuchte
Luminaire sans cadre

900057 TURCONA-Z

ceiling light; steel, aluminium, white / plastic, white
Deckenleuchte; Stahl, Alu, weiss / Kunststoff, weiss
plafonnier; acier, aluminium, blanc / plastique, blanc

L 300, B 300, H 50

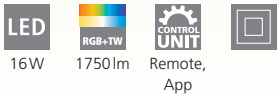

900058 TURCONA-Z

ceiling light; steel, aluminium, white / plastic, white
Deckenleuchte; Stahl, Alu, weiss / Kunststoff, weiss
plafonnier; acier, aluminium, blanc / plastique, blanc

L 450, B 450, H 70



900059 TURCONA-Z

ceiling light; steel, aluminium, white / plastic, white
Deckenleuchte; Stahl, Alu, weiss / Kunststoff, weiss
plafonnier; acier, aluminium, blanc / plastique, blanc

L 600, B 600, H 75

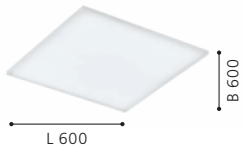
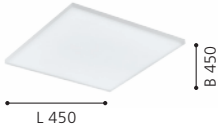
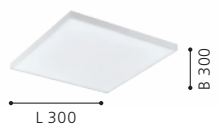



900062

LED



900061

LED

900062 TURCONA-Z

ceiling light; steel, aluminium, white / plastic, white
Deckenleuchte; Stahl, Alu, weiss / Kunststoff, weiss
plafonnier; acier, aluminium, blanc / plastique, blanc

L 1200, B 100, H 50

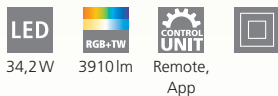

900061 TURCONA-Z

ceiling light; steel, aluminium, white / plastic, white
Deckenleuchte; Stahl, Alu, weiss / Kunststoff, weiss
plafonnier; acier, aluminium, blanc / plastique, blanc

L 1200, B 300, H 50

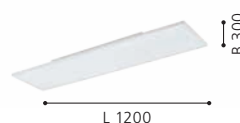



900044



900045



900046



900044 SALOBRENA-Z

ceiling light; aluminium, white / plastic, white
Deckenleuchte; Alu, weiss / Kunststoff, weiss
plafonnier; aluminium, blanc / plastique, blanc

L 300, B 300, H 50



15,3W 1790lm Remote, App

900045 SALOBRENA-Z

ceiling light; aluminium, white / plastic, white
Deckenleuchte; Alu, weiss / Kunststoff, weiss
plafonnier; aluminium, blanc / plastique, blanc

L 450, B 450, H 50

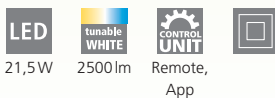

21,5W 2500lm Remote, App

900046 SALOBRENA-Z

ceiling light; aluminium, white / plastic, white
Deckenleuchte; Alu, weiss / Kunststoff, weiss
plafonnier; aluminium, blanc / plastique, blanc

L 595, B 595, H 50

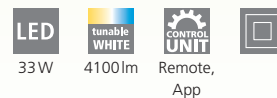

33W 4100lm Remote, App



9 008606 221813

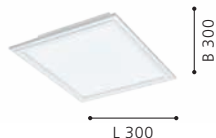

9 008606 221820

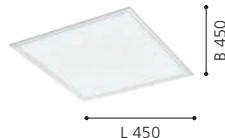

9 008606 221837

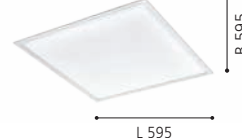



900047

LED



900048

LED



900047 SALOBRENA-Z

ceiling light; aluminium, white / plastic, white
Deckenleuchte; Alu, weiss / Kunststoff, weiss
plafonnier; aluminium, blanc / plastique, blanc

L 1200, B 300, H 50



33,5W 4150lm Remote, App



900048 SALOBRENA-Z

ceiling light; aluminium, white / plastic, white
Deckenleuchte; Alu, weiss / Kunststoff, weiss
plafonnier; aluminium, blanc / plastique, blanc

L 1200, B 100, H 45



33,5W 4150lm Remote, App



Zubehör inkludiert
Accessoires inclus



900049



900051



900052



900049 SALOBRENA-Z

ceiling light; aluminium, black / plastic, white
Deckenleuchte; Alu, schwarz / Kunststoff, weiss
plafonnier; aluminium, noir / plastique, blanc

L 300, B 300, H 50

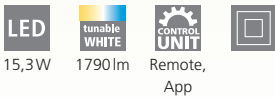

15,3W 1790lm Remote, App



9 008606 221868



900051 SALOBRENA-Z

ceiling light; aluminium, black / plastic, white
Deckenleuchte; Alu, schwarz / Kunststoff, weiss
plafonnier; aluminium, noir / plastique, blanc

L 450, B 450, H 50



21,5W 2500lm Remote, App



9 008606 221875



900052 SALOBRENA-Z

ceiling light; aluminium, black / plastic, white
Deckenleuchte; Alu, schwarz / Kunststoff, weiss
plafonnier; aluminium, noir / plastique, blanc

L 595, B 595, H 50

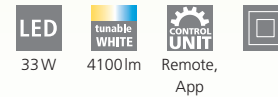

33W 4100lm Remote, App



9 008606 221882





900053



900095



900053 SALOBRENA-Z

ceiling light; aluminium, black / plastic, white
 Deckenleuchte; Alu, schwarz / Kunststoff, weiss
 plafonnier; aluminium, noir / plastique, blanc

L 1200, B 300, H 50



33,5W 4150lm Remote, App



9 008606 221899

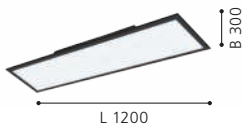

900095 SALOBRENA-Z

ceiling light; aluminium, steel, black / plastic, white
 Deckenleuchte; Alu, Stahl, schwarz / Kunststoff, weiss
 plafonnier; aluminium, acier, noir / plastique, blanc

L 1200, B 100, H 45



33,5W 4150lm Remote, App



9 008606 225552

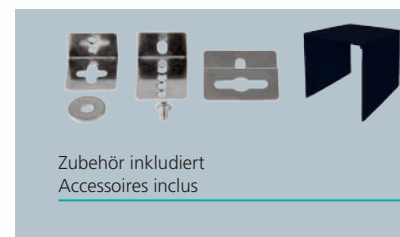
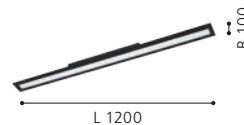

Zubehör inkludiert
 Accessoires inclus

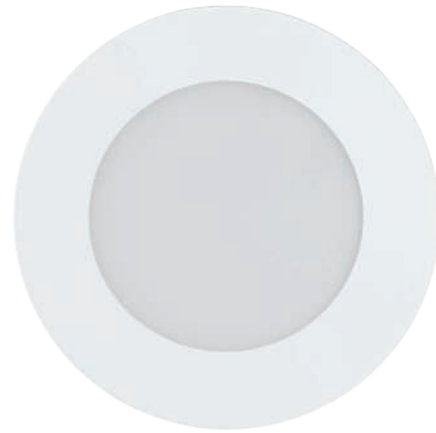

900099



900101



900102



900099 FUEVA-Z

recessed light; steel, white / plastic, white
Einbauleuchte; Stahl, weiss / Kunststoff, weiss
luminaire encastrable; acier, blanc / plastique, blanc

H 26, Ø 85



3x 2,8W 3x 390lm Remote, App Ø75 IP20, IP44



9 008606 225569



Ø 85

900101 FUEVA-Z

recessed light; steel, white / plastic, white
Einbauleuchte; Stahl, weiss / Kunststoff, weiss
luminaire encastrable; acier, blanc / plastique, blanc

H 26, Ø 120



5,4W 800lm Remote, App Ø105 IP20, IP44



9 008606 225576



Ø 120

900102 FUEVA-Z

recessed light; steel, white / plastic, white
Einbauleuchte; Stahl, weiss / Kunststoff, weiss
luminaire encastrable; acier, blanc / plastique, blanc

H 26, Ø 165



10,5W 1520lm Remote, App Ø155 IP20, IP44



9 008606 225583



Ø 165

98842

LED



98842 FUEVA-Z

recessed light; aluminium, white / plastic, white
Einbauleuchte; Alu, weiss / Kunststoff, weiss
luminaire encastrable; aluminium, blanc / plastique, blanc

Ø 216, ET 26



16,5W



2100lm



Remote,
App



Ø205



IP20, IP44



9 002759 988425



Ø 216



900112



900111



900113



900111 FUEVA-Z

recessed light; steel, satin nickel / plastic, white
Einbauleuchte; Stahl, nickel-matt / Kunststoff, weiss
luminaire encastrable; acier, nickel mat / plastique, blanc

H 26, Ø 85



3x 2,8W



3x 390lm



Remote,
App



Ø 75



IP20, IP44



Ø 85

900112 FUEVA-Z

recessed light; steel, satin nickel / plastic, white
Einbauleuchte; Stahl, nickel-matt / Kunststoff, weiss
luminaire encastrable; acier, nickel mat / plastique, blanc

H 26, Ø 120



5,4W



800lm



Remote,
App



Ø 105



IP20, IP44



Ø 120

900113 FUEVA-Z

recessed light; steel, satin nickel / plastic, white
Einbauleuchte; Stahl, nickel-matt / Kunststoff, weiss
luminaire encastrable; acier, nickel mat / plastique, blanc

H 26, Ø 165



10,5W



1520lm



Remote,
App



Ø 155



IP20, IP44



Ø 165



98844

LED

98844 FUEVA-Z

recessed light; aluminium, satin nickel / plastic, white
 Einbauleuchte; Alu, nickel-matt / Kunststoff, weiss
 luminaire encastrable; aluminium, nickel mat / plastique, blanc

Ø 216, ET 26

-  LED
16,5W
-  tunable
WHITE
2100lm
-  CONTROL
UNIT
Remote,
App
-  Ø 205
-  IP20, IP44





900105



900106



98846



900105 FUEVA-Z

recessed light; steel, black / plastic, white
Einbauleuchte; Stahl, schwarz / Kunststoff, weiss
luminaire encastrable; acier, noir / plastique, blanc

H 26, Ø 85



900106 FUEVA-Z

recessed light; steel, black / plastic, white
Einbauleuchte; Stahl, schwarz / Kunststoff, weiss
luminaire encastrable; acier, noir / plastique, blanc

H 26, Ø 120



98846 FUEVA-Z

recessed light; aluminium, black / plastic, white
Einbauleuchte; Alu, schwarz / Kunststoff, weiss
luminaire encastrable; aluminium, noir / plastique, blanc

Ø 216, ET 26





900107

LED

900107 FUEVA-Z

recessed light; steel, black / plastic, white
 Einbauleuchte; Stahl, schwarz / Kunststoff, weiss
 luminaire encastrable; acier, noir / plastique, blanc

H 26, Ø 165



10,5W



1520lm



Remote,
App



Ø 155



IP20, IP44



9 008606 225637



Ø 165



900104

LED



900103

LED



98849

LED

900104 FUEVA-Z

surface-mounted light; steel, white / plastic, white
Aufbauleuchte; Stahl, weiss / Kunststoff, weiss
luminaire en saillie; acier, blanc / plastique, blanc

L 210, B 210, H 28



16,5W



2250lm



Remote,
App



IP44



98849 FUEVA-Z

surface-mounted light; aluminium, white / plastic, white
Aufbauleuchte; Alu, weiss / Kunststoff, weiss
luminaire en saillie; aluminium, blanc / plastique, blanc

L 285, B 285, H 28



19,5W



2500lm



Remote,
App



IP44



900103 FUEVA-Z

surface-mounted light; steel, white / plastic, white
Aufbauleuchte; Stahl, weiss / Kunststoff, weiss
luminaire en saillie; acier, blanc / plastique, blanc

H 28, Ø 210



16,5W



2250lm



Remote,
App



IP44



9 008606 225606

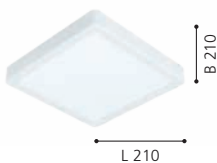

9 002759 988494

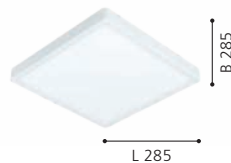

9 008606 225590

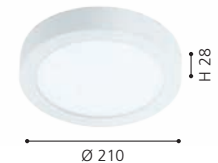







98843 FUEVA-Z

surface-mounted light; aluminium, white / plastic, white
 Aufbauleuchte; Alu, weiss / Kunststoff, weiss
 luminaire en saillie; aluminium, blanc / plastique, blanc

H 28, Ø 285

-  LED
19,5W
-  tunable
WHITE
2500lm
-  CONTROL
UNIT
Remote,
App
-  IP44
- 

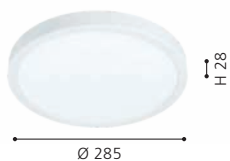

98843





900114



900115



98845



900114 FUEVA-Z

surface-mounted light; steel, satin nickel / plastic, white
Aufbauleuchte; Stahl, nickel-matt / Kunststoff, weiss
luminaire en saillie; acier, nickel mat / plastique, blanc

H 28, Ø 210



16,5W



2250lm



Remote,
App



IP44



98845 FUEVA-Z

surface-mounted light; aluminium, satin nickel / plastic, white
Aufbauleuchte; Alu, nickel-matt / Kunststoff, weiss
luminaire en saillie; aluminium, nickel mat / plastique, blanc

H 28, Ø 285



19,5W



2500lm



Remote,
App



IP44



900115 FUEVA-Z

surface-mounted light; steel, satin nickel / plastic, white
Aufbauleuchte; Stahl, nickel-matt / Kunststoff, weiss
luminaire en saillie; acier, nickel mat / plastique, blanc

L 210, B 210, H 28



16,5W



2250lm



Remote,
App



IP44

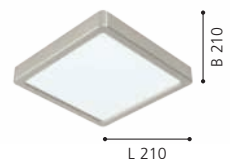



98852 FUEVA-Z

surface-mounted light; aluminium, satin nickel / plastic, white
Aufbauleuchte; Alu, nickel-matt / Kunststoff, weiss
luminaire en saillie; aluminium, nickel mat / plastique, blanc

L 285, B 285, H 28

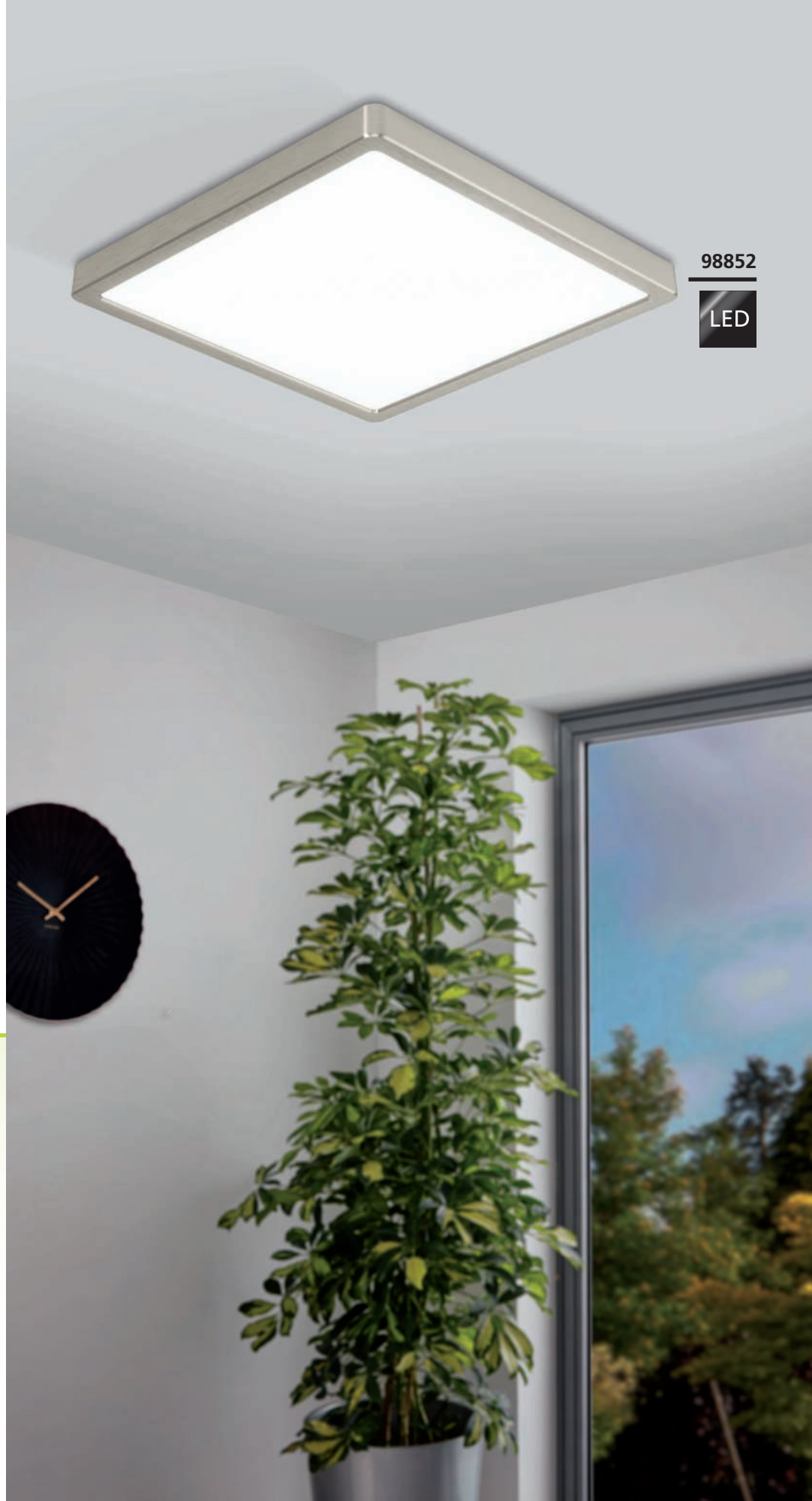
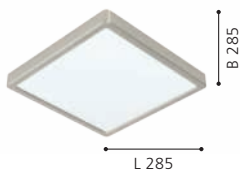
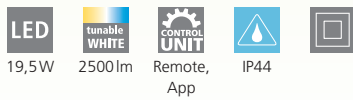

98852





900108



98854



98847



900108 FUEVA-Z

surface-mounted light; steel, black / plastic, white
Aufbauleuchte; Stahl, schwarz / Kunststoff, weiss
luminaire en saillie; acier, noir / plastique, blanc

H 28, Ø 210



16,5W



2250lm



Remote,
App



IP44



98847 FUEVA-Z

surface-mounted light; aluminium, black / plastic, white
Aufbauleuchte; Alu, schwarz / Kunststoff, weiss
luminaire en saillie; aluminium, noir / plastique, blanc

H 28, Ø 285



19,5W



2500lm



Remote,
App



IP44



98854 FUEVA-Z

surface-mounted light; aluminium, black / plastic, white
Aufbauleuchte; Alu, schwarz / Kunststoff, weiss
luminaire en saillie; aluminium, noir / plastique, blanc

L 285, B 285, H 28



19,5W



2500lm



Remote,
App



IP44



9 008606 225644



9 002759 988470



9 002759 988548





900109

LED

900109 FUEVA-Z

surface-mounted light; steel, black / plastic, white
Aufbauleuchte; Stahl, schwarz / Kunststoff, weiss
luminaire en saillie; acier, noir / plastique, blanc

L 210, B 210, H 28



16,5W



2250lm



Remote,
App



IP44



9 008606 225651

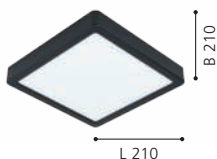



900088



900086



900089



ROVITO-Z

These lights have individually controllable light settings on the inside and outside of the frame.

Diese Leuchten verfügen über individuell steuerbare Lichteinstellungen der Rahmen innen und außen.

Ces lumières ont des paramètres d'éclairage contrôlables individuellement du cadre.

900088 ROVITO-Z

ceiling light; plastic, white / plastic, white
Deckenleuchte; Kunststoff, weiss / Kunststoff, weiss
plafonnier; plastique, blanc / plastique, blanc

L 295, B 295, H 25



14,6W



1700lm



Remote,
App



9 008606 225491



900089 ROVITO-Z

ceiling light; plastic, white / plastic, white
Deckenleuchte; Kunststoff, weiss / Kunststoff, weiss
plafonnier; plastique, blanc / plastique, blanc

L 420, B 420, H 25



16,5W



2200lm



Remote,
App



9 008606 225507



900086 ROVITO-Z

ceiling light; plastic, white / plastic, white
Deckenleuchte; Kunststoff, weiss / Kunststoff, weiss
plafonnier; plastique, blanc / plastique, blanc

H 25, Ø 295



14,6W



1700lm



Remote,
App



9 008606 225477





900087



900087 ROVITO-Z

ceiling light; plastic, white / plastic, white
 Deckenleuchte; Kunststoff, weiss / Kunststoff, weiss
 plafonnier; plastique, blanc / plastique, blanc

H 25, Ø 420



16,5W



2200lm



Remote,
App



9 008606 225484





900093



900092



900094



ROVITO-Z

These lights have individually controllable light settings on the inside and outside of the frame.

Diese Leuchten verfügen über individuell steuerbare Lichteinstellungen der Rahmen innen und außen.

Ces lumières ont des paramètres d'éclairage contrôlables individuellement du cadre.

900093 ROVITO-Z

ceiling light; plastic, black / plastic, white
Deckenleuchte; Kunststoff, schwarz / Kunststoff, weiss
plafonnier; plastique, noir / plastique, blanc

L 295, B 295, H 25

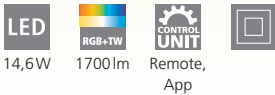

14,6W 1700lm Remote, App

900094 ROVITO-Z

ceiling light; plastic, black / plastic, white
Deckenleuchte; Kunststoff, schwarz / Kunststoff, weiss
plafonnier; plastique, noir / plastique, blanc

L 420, B 420, H 25



16,5W 2200lm Remote, App

900092 ROVITO-Z

ceiling light; plastic, black / plastic, white
Deckenleuchte; Kunststoff, schwarz / Kunststoff, weiss
plafonnier; plastique, noir / plastique, blanc

H 25, Ø 420

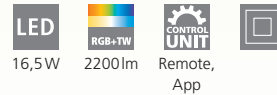

16,5W 2200lm Remote, App



9 008606 225538

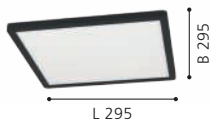

9 008606 225545



9 008606 225521





900091



900091 ROVITO-Z

ceiling light; plastic, black / plastic, white

Deckenleuchte; Kunststoff, schwarz / Kunststoff, weiss

plafonnier; plastique, noir / plastique, blanc

H 25, Ø 295



14,6W



1700lm



Remote,
App



9 008606 225514



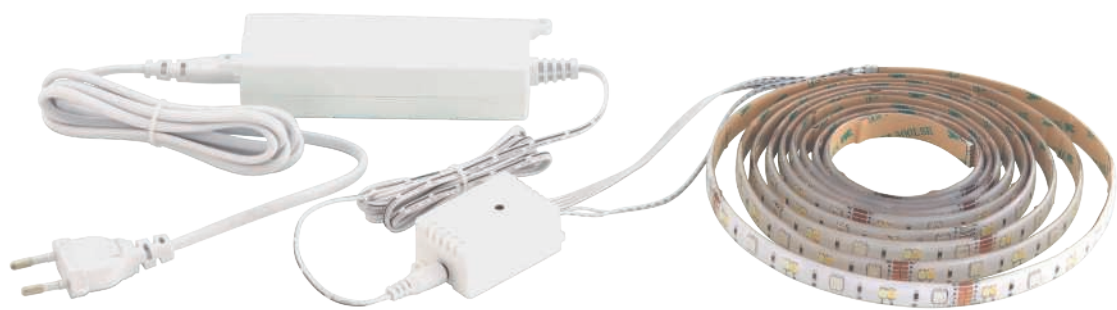

99686

99687



99684

99685



99684

Driver included

Treiber inkludiert

Chauffeur inclus



1x 1,5 m



99685

Extension for starter set 99684 without driver

Erweiterung für Starterset 99684 ohne Treiber

Rallonge pour kit de démarrage 99684 sans pilote

99686, 99687

Driver included

Treiber inkludiert

Chauffeur inclus



1x 1,5 m

99686 LED STRIPE-Z

bar / strip light; plastic, white
Leuchtband/-stab; Kunststoff, weiss
bande lumineuse / bâton l; plastique, blanc

L 5000, B 10

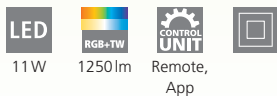

11W

1250lm

Remote,
App

99687 LED STRIPE-Z

bar / strip light; plastic, white
Leuchtband/-stab; Kunststoff, weiss
bande lumineuse / bâton l; plastique, blanc

L 8000, B 12, H 3

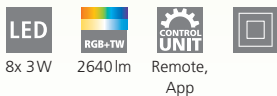

8x 3W

2640lm

Remote,
App

99684 LED STRIPE-Z

bar / strip light; plastic, white
Leuchtband/-stab; Kunststoff, weiss
bande lumineuse / bâton l; plastique, blanc

L 3000, B 8



13,5W

1450lm

Remote,
App



9 002759 996864



L 5000



9 002759 996871



L 8000



9 002759 996840



L 3000



99687



99685 LED STRIPE-Z

bar / strip light; plastic, white
 Leuchtband/-stab; Kunststoff, weiss
 bande lumineuse / bâton l; plastique, blanc

L 2000, B 8

LED 9W
 tunable WHITE 950lm
 CONTROL UNIT Remote, App

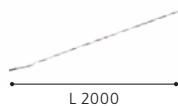



EGLO CONNECT.Z ILLUMINANT

One illuminant – numerous possibilities: 16.7 million colours and over 50,000 white tones ensure the right atmosphere in your home at all times. The illuminant can be controlled via remote control or app using Bluetooth technology: You can control the brightness or adjust colour tones – and all this without complicated installation and comfortably from the sofa.

But the illuminant can do much more: it can be expanded at will using intelligent mesh technology, and up to 50 illuminants can be grouped together. This makes it easy to create and program a wide variety of lighting scenarios. You can also use the app to select from a large number of pre-set lighting scenes.

Security is not neglected either, as the illuminants form a self-contained network and are therefore protected from external access.

EGLO CONNECT.Z LEUCHTMITTEL

Ein Leuchtmittel – zahlreiche Möglichkeiten: 16,7 Millionen Farben und über 50.000 Weißtöne sorgen jederzeit für die richtige Stimmung in Ihrem Heim. Über die Bluetooth-Technologie kann das Leuchtmittel per Fernbedienung oder App gesteuert werden: Sie können die Helligkeit kontrollieren oder Farbtöne einstellen – und das alles ohne aufwändige Installation und bequem vom Sofa aus.

Aber das Leuchtmittel kann noch viel mehr: es lässt sich per intelligenter Mesh-Technologie beliebig erweitern, bis zu 50 Leuchtmittel sind hierbei gruppierbar. So lassen sich problemlos und einfach unterschiedlichste Lichtszenarien erstellen und programmieren. Mit der App können Sie aber auch aus einer Vielzahl vorgegebener Lichtstimmungen auswählen.

Auch die Sicherheit kommt nicht zu kurz, denn die Leuchtmittel bilden ein in sich geschlossenes Netzwerk und sind somit vor Zugriffen von Außen geschützt.

AMPOULE EGLO CONNECT.Z

Une seule ampoule – de nombreuses possibilités : 16,7 millions de couleurs et plus de 50 000 tons de blanc assurent à tout moment la bonne ambiance dans votre maison. L'ampoule peut être commandée via une télécommande ou une appli, utilisant la technologie Bluetooth : Vous pouvez contrôler la luminosité ou régler les tons de couleurs – et tout cela sans installation compliquée et de manière confortablement depuis votre canapé.

Mais l'ampoule peut faire beaucoup plus : elle peut être étendue à volonté grâce à la technologie Mesh intelligentes, et jusqu'à 50 ampoules peuvent être regroupées. Il est ainsi facile de créer et de programmer une grande variété de scène lumineuse. Vous pouvez également utiliser l'appli pour sélectionner un grand nombre d'ambiance lumineuse prédéfinies.

La sécurité n'est pas négligée non plus, car les ampoules forment un réseau fermé et sont donc protégées des accès externes.

12253 E27-LED-A60

Dimensions Abmessungen / Dimensions	L 118, Ø 60
Socket Sockel / Douille	E27
Wattage Wattage / Puissance	9 W
Light Colour Lichtfarbe / Couleur lumineuse	2765 K
Operating voltage Betriebsspannung / Tension de fonctionnement	220-240V 50/60Hz
Lifetime Lebensdauer / Durée de vie	15000 h
Colour rendering index Farbwiedergabeindex / L'indice de restitution de couleurs	80



12254 E27-LED-G95

Dimensions Abmessungen / Dimensions	L 142, Ø 95
Socket Sockel / Douille	E27
Wattage Wattage / Puissance	13,5 W
Light Colour Lichtfarbe / Couleur lumineuse	2765 K
Operating voltage Betriebsspannung / Tension de fonctionnement	220-240V 50/60Hz
Lifetime Lebensdauer / Durée de vie	15000 h
Colour rendering index Farbwiedergabeindex / L'indice de restitution de couleurs	80



12252 E14-LED-P45

Dimensions Abmessungen / Dimensions	L 92, Ø 45
Socket Sockel / Douille	E14
Wattage Wattage / Puissance	4,9 W
Light Colour Lichtfarbe / Couleur lumineuse	2765 K
Operating voltage Betriebsspannung / Tension de fonctionnement	220-240V 50/60Hz
Lifetime Lebensdauer / Durée de vie	15000 h
Colour rendering index Farbwiedergabeindex / L'indice de restitution de couleurs	80



12251 GU10-LED

Dimensions Abmessungen / Dimensions	L 59, Ø 50
Socket Sockel / Douille	GU10
Wattage Wattage / Puissance	4,9 W
Light Colour Lichtfarbe / Couleur lumineuse	2765 K
Operating voltage Betriebsspannung / Tension de fonctionnement	220-240V 50/60Hz
Lifetime Lebensdauer / Durée de vie	15000 h
Colour rendering index Farbwiedergabeindex / L'indice de restitution de couleurs	83
Beamangle Ausstrahlwinkel / Angle de rayonnement	45°



12226 E27-LED-A60

Dimensions Abmessungen / Dimensions	L 105, Ø 60
Socket Sockel / Douille	E27
Wattage Wattage / Puissance	6 W
Light Colour Lichtfarbe / Couleur lumineuse	2700 K
Operating voltage Betriebsspannung / Tension de fonctionnement	220-240V 50/60Hz
Lifetime Lebensdauer / Durée de vie	15000 h
Colour rendering index Farbwiedergabeindex / L'indice de restitution de couleurs	80



6 W

806 lm
LUMEN

A+ E warm WHITE

6 W ~ 60 W



9 002759 122263

12227 E27-LED-ST64

Dimensions Abmessungen / Dimensions	L 142, Ø 64
Socket Sockel / Douille	E27
Wattage Wattage / Puissance	6 W
Light Colour Lichtfarbe / Couleur lumineuse	2700 K
Operating voltage Betriebsspannung / Tension de fonctionnement	220-240V 50/60Hz
Lifetime Lebensdauer / Durée de vie	15000 h
Colour rendering index Farbwiedergabeindex / L'indice de restitution de couleurs	80



6 W

806 lm
LUMEN

A+ E warm WHITE

6 W ~ 60 W



9 002759 122270

12228 E27-LED-G80

Dimensions Abmessungen / Dimensions	L 120, Ø 80
Socket Sockel / Douille	E27
Wattage Wattage / Puissance	6 W
Light Colour Lichtfarbe / Couleur lumineuse	2700 K
Operating voltage Betriebsspannung / Tension de fonctionnement	220-240V 50/60Hz
Lifetime Lebensdauer / Durée de vie	15000 h
Colour rendering index Farbwiedergabeindex / L'indice de restitution de couleurs	80



6 W

806 lm
LUMEN

A+ E warm WHITE

6 W ~ 60 W



9 002759 122287

12229 E27-LED-G95

Dimensions Abmessungen / Dimensions	L 140, Ø 95
Socket Sockel / Douille	E27
Wattage Wattage / Puissance	6 W
Light Colour Lichtfarbe / Couleur lumineuse	2700 K
Operating voltage Betriebsspannung / Tension de fonctionnement	220-240V 50/60Hz
Lifetime Lebensdauer / Durée de vie	15000 h
Colour rendering index Farbwiedergabeindex / L'indice de restitution de couleurs	80



6 W

806 lm
LUMEN



warm
WHITE



6 W



60 W



12231 E27-LED-A60

Dimensions Abmessungen / Dimensions	L 105, Ø 60
Socket Sockel / Douille	E27
Wattage Wattage / Puissance	6 W
Light Colour Lichtfarbe / Couleur lumineuse	4000 K
Operating voltage Betriebsspannung / Tension de fonctionnement	220-240V 50/60Hz
Lifetime Lebensdauer / Durée de vie	15000 h
Colour rendering index Farbwiedergabeindex / L'indice de restitution de couleurs	80



6 W

806 lm
LUMEN



neutral
WHITE



6 W



60 W



12232 E27-LED-ST64

Dimensions Abmessungen / Dimensions	L 142, Ø 64
Socket Sockel / Douille	E27
Wattage Wattage / Puissance	6 W
Light Colour Lichtfarbe / Couleur lumineuse	4000 K
Operating voltage Betriebsspannung / Tension de fonctionnement	220-240V 50/60Hz
Lifetime Lebensdauer / Durée de vie	15000 h
Colour rendering index Farbwiedergabeindex / L'indice de restitution de couleurs	80



6 W

806 lm
LUMEN



neutral
WHITE



6 W



60 W



12233 E27-LED-G80

Dimensions Abmessungen / Dimensions	L 120, Ø 80
Socket Sockel / Douille	E27
Wattage Wattage / Puissance	6 W
Light Colour Lichtfarbe / Couleur lumineuse	4000 K
Operating voltage Betriebsspannung / Tension de fonctionnement	220-240V 50/60Hz
Lifetime Lebensdauer / Durée de vie	15000 h
Colour rendering index Farbwiedergabeindex / L'indice de restitution de couleurs	80



6 W
806 lm
LUMEN



12234 E27-LED-G95

Dimensions Abmessungen / Dimensions	L 140, Ø 95
Socket Sockel / Douille	E27
Wattage Wattage / Puissance	6 W
Light Colour Lichtfarbe / Couleur lumineuse	4000 K
Operating voltage Betriebsspannung / Tension de fonctionnement	220-240V 50/60Hz
Lifetime Lebensdauer / Durée de vie	15000 h
Colour rendering index Farbwiedergabeindex / L'indice de restitution de couleurs	80



6 W
806 lm
LUMEN



12235 E27-LED-A60

Dimensions Abmessungen / Dimensions	L 105, Ø 60
Socket Sockel / Douille	E27
Wattage Wattage / Puissance	6 W
Light Colour Lichtfarbe / Couleur lumineuse	2265 K
Operating voltage Betriebsspannung / Tension de fonctionnement	220-240V 50/60Hz
Lifetime Lebensdauer / Durée de vie	15000 h
Colour rendering index Farbwiedergabeindex / L'indice de restitution de couleurs	80



6 W
806 lm
LUMEN



12236 E27-LED-ST64

Dimensions Abmessungen / Dimensions	L 142, Ø 64
Socket Sockel / Douille	E27
Wattage Wattage / Puissance	6 W
Light Colour Lichtfarbe / Couleur lumineuse	2265 K
Operating voltage Betriebsspannung / Tension de fonctionnement	220-240V 50/60Hz
Lifetime Lebensdauer / Durée de vie	15000 h
Colour rendering index Farbwiedergabeindex / L'indice de restitution de couleurs	80



6 W

806 lm
LUMEN



12237 E27-LED-G80

Dimensions Abmessungen / Dimensions	L 120, Ø 80
Socket Sockel / Douille	E27
Wattage Wattage / Puissance	6 W
Light Colour Lichtfarbe / Couleur lumineuse	2265 K
Operating voltage Betriebsspannung / Tension de fonctionnement	220-240V 50/60Hz
Lifetime Lebensdauer / Durée de vie	15000 h
Colour rendering index Farbwiedergabeindex / L'indice de restitution de couleurs	80



6 W

806 lm
LUMEN



12239 E27-LED-G95

Dimensions Abmessungen / Dimensions	L 140, Ø 95
Socket Sockel / Douille	E27
Wattage Wattage / Puissance	6 W
Light Colour Lichtfarbe / Couleur lumineuse	2265 K
Operating voltage Betriebsspannung / Tension de fonctionnement	220-240V 50/60Hz
Lifetime Lebensdauer / Durée de vie	15000 h
Colour rendering index Farbwiedergabeindex / L'indice de restitution de couleurs	80



6 W

806 lm
LUMEN



12221 E27-LED-A60

Dimensions Abmessungen / Dimensions	L 105, Ø 60
Socket Sockel / Douille	E27
Wattage Wattage / Puissance	4,9 W
Light Colour Lichtfarbe / Couleur lumineuse	2200 K
Operating voltage Betriebsspannung / Tension de fonctionnement	220-240V 50/60Hz
Lifetime Lebensdauer / Durée de vie	15000 h
Colour rendering index Farbwiedergabeindex / L'indice de restitution de couleurs	80



4,9 W

500 lm
LUMEN

AG F warm WHITE

4,9 W ~ 41 W



9 002759 122218

12222 E27-LED-ST64

Dimensions Abmessungen / Dimensions	L 142, Ø 64
Socket Sockel / Douille	E27
Wattage Wattage / Puissance	4,9 W
Light Colour Lichtfarbe / Couleur lumineuse	2200 K
Operating voltage Betriebsspannung / Tension de fonctionnement	220-240V 50/60Hz
Lifetime Lebensdauer / Durée de vie	15000 h
Colour rendering index Farbwiedergabeindex / L'indice de restitution de couleurs	80



4,9 W

500 lm
LUMEN

AG F warm WHITE

4,9 W ~ 41 W



9 002759 122225

12223 E27-LED-G80

Dimensions Abmessungen / Dimensions	L 120, Ø 80
Socket Sockel / Douille	E27
Wattage Wattage / Puissance	4,9 W
Light Colour Lichtfarbe / Couleur lumineuse	2200 K
Operating voltage Betriebsspannung / Tension de fonctionnement	220-240V 50/60Hz
Lifetime Lebensdauer / Durée de vie	15000 h
Colour rendering index Farbwiedergabeindex / L'indice de restitution de couleurs	80



4,9 W

500 lm
LUMEN

AG F warm WHITE

4,9 W ~ 41 W



9 002759 122232

12224 E27-LED-G95

Dimensions Abmessungen / Dimensions	L 140, Ø 95
Socket Sockel / Douille	E27
Wattage Wattage / Puissance	4,9 W
Light Colour Lichtfarbe / Couleur lumineuse	2200 K
Operating voltage Betriebsspannung / Tension de fonctionnement	220-240V 50/60Hz
Lifetime Lebensdauer / Durée de vie	15000 h
Colour rendering index Farbwiedergabeindex / L'indice de restitution de couleurs	80



4,9 W

500 lm
LUMEN



4,9 W



41 W



12225 E27-LED-G125

Dimensions Abmessungen / Dimensions	L 172, Ø 125
Socket Sockel / Douille	E27
Wattage Wattage / Puissance	6 W
Light Colour Lichtfarbe / Couleur lumineuse	2200 K
Operating voltage Betriebsspannung / Tension de fonctionnement	220-240V 50/60Hz
Lifetime Lebensdauer / Durée de vie	15000 h
Colour rendering index Farbwiedergabeindex / L'indice de restitution de couleurs	80



6 W

650 lm
LUMEN



6 W



50 W



12241 E27-LED-A60

Dimensions Abmessungen / Dimensions	L 105, Ø 60
Socket Sockel / Douille	E27
Wattage Wattage / Puissance	4,9 W
Light Colour Lichtfarbe / Couleur lumineuse	2265 K
Operating voltage Betriebsspannung / Tension de fonctionnement	220-240V 50/60Hz
Lifetime Lebensdauer / Durée de vie	15000 h
Colour rendering index Farbwiedergabeindex / L'indice de restitution de couleurs	80



4,9 W
360 lm
LUMEN



12242 E27-LED-ST64

Dimensions Abmessungen / Dimensions	L 142, Ø 64
Socket Sockel / Douille	E27
Wattage Wattage / Puissance	4,9 W
Light Colour Lichtfarbe / Couleur lumineuse	2265 K
Operating voltage Betriebsspannung / Tension de fonctionnement	220-240V 50/60Hz
Lifetime Lebensdauer / Durée de vie	15000 h
Colour rendering index Farbwiedergabeindex / L'indice de restitution de couleurs	80



4,9 W
360 lm
LUMEN



12243 E27-LED-G80

Dimensions Abmessungen / Dimensions	L 120, Ø 80
Socket Sockel / Douille	E27
Wattage Wattage / Puissance	4,9 W
Light Colour Lichtfarbe / Couleur lumineuse	2265 K
Operating voltage Betriebsspannung / Tension de fonctionnement	220-240V 50/60Hz
Lifetime Lebensdauer / Durée de vie	15000 h
Colour rendering index Farbwiedergabeindex / L'indice de restitution de couleurs	80



4,9 W
360 lm
LUMEN



12244 E27-LED-G95

Dimensions Abmessungen / Dimensions	L 140, Ø 95
Socket Sockel / Douille	E27
Wattage Wattage / Puissance	4,9 W
Light Colour Lichtfarbe / Couleur lumineuse	2265 K
Operating voltage Betriebsspannung / Tension de fonctionnement	220-240V 50/60Hz
Lifetime Lebensdauer / Durée de vie	15000 h
Colour rendering index Farbwiedergabeindex / L'indice de restitution de couleurs	80



12245 E27-LED-G125

Dimensions Abmessungen / Dimensions	L 170, Ø 125
Socket Sockel / Douille	E27
Wattage Wattage / Puissance	4,9 W
Light Colour Lichtfarbe / Couleur lumineuse	2265 K
Operating voltage Betriebsspannung / Tension de fonctionnement	220-240V 50/60Hz
Lifetime Lebensdauer / Durée de vie	15000 h
Colour rendering index Farbwiedergabeindex / L'indice de restitution de couleurs	80



12255 E27-LED-A60

Dimensions Abmessungen / Dimensions	L 105, Ø 60
Socket Sockel / Douille	E27
Wattage Wattage / Puissance	6 W
Light Colour Lichtfarbe / Couleur lumineuse	4000 K
Operating voltage Betriebsspannung / Tension de fonctionnement	220-240V 50/60Hz
Lifetime Lebensdauer / Durée de vie	15000 h
Colour rendering index Farbwiedergabeindex / L'indice de restitution de couleurs	80



incl./inkl./inclus



6 W
806 lm
LUMEN



12256 E27-LED-ST64

Dimensions Abmessungen / Dimensions	L 142, Ø 64
Socket Sockel / Douille	E27
Wattage Wattage / Puissance	4,9 W
Light Colour Lichtfarbe / Couleur lumineuse	2200 K
Operating voltage Betriebsspannung / Tension de fonctionnement	220-240V 50/60Hz
Lifetime Lebensdauer / Durée de vie	15000 h
Colour rendering index Farbwiedergabeindex / L'indice de restitution de couleurs	80



incl./inkl./inclus



4,9 W
500 lm
LUMEN



12257 E27-LED-A60

Dimensions Abmessungen / Dimensions	L 105, Ø 60
Socket Sockel / Douille	E27
Wattage Wattage / Puissance	6 W
Light Colour Lichtfarbe / Couleur lumineuse	4000 K
Operating voltage Betriebsspannung / Tension de fonctionnement	220-240V 50/60Hz
Lifetime Lebensdauer / Durée de vie	15000 h
Colour rendering index Farbwiedergabeindex / L'indice de restitution de couleurs	80



incl./inkl./inclus



6 W
806 lm
LUMEN



12258 E27-LED-ST64

Dimensions Abmessungen / Dimensions	L 142, Ø 64
Socket Sockel / Douille	E27
Wattage Wattage / Puissance	4,9 W
Light Colour Lichtfarbe / Couleur lumineuse	2200 K
Operating voltage Betriebsspannung / Tension de fonctionnement	220-240V 50/60Hz
Lifetime Lebensdauer / Durée de vie	15000 h
Colour rendering index Farbwiedergabeindex / L'indice de restitution de couleurs	80



incl./inkl./inclus

4,9 W

500 lm
LUMEN



warm
WHITE



4,9 W



41 W



EGLO Access

Let **light** follow
your **life**



OVERVIEW

EGLO ACCESS



ACCESS REMOTE
p. 102



ZUBIETA-A
p. 102-104



SILERAS-A
p. 105



FRANIA-A
p. 106-107



MORATICA-A
p. 107



SARSINA-A
p. 108



SALOBRENA-A
p. 110-111



FUEVA-A
p. 112



This product is available in different colors and shapes./ Dieser Artikel ist in unterschiedlichen Farben und Formen verfügbar.
Cet article est disponible en différentes couleurs et formes.

FUNCTIONS

FUNKTIONEN FONCTIONS

Relax with warm light and leave the hustle and bustle of everyday life behind you. Concentrate on your work or dispel fatigue, with neutral white light the energy level is replenished. EGLO Access offers these possibilities and many more. All functions and highlights at a glance:

- › It works with radio frequency technology and allows 360 degree control
- › Controllable up to a distance of 10 meters
- › Up to 8 different items can be connected
- › Easy handling thanks to 4 ready-made settings and 2 memory functions

NIGHT LIGHT

RELAX MODE

WORK MODE

SWITCH OFF AFTER 30 MINUTES

Mit warmem Licht entspannen und die Hektik des Alltages hinter sich lassen. Konzentriert arbeiten oder die Müdigkeit vertreiben, mit neutralweißem Licht wird das Energielevel wieder aufgefüllt. Diese Möglichkeiten und noch viele mehr bietet Ihnen EGLO Access. Alle Funktionen und Highlights auf einem Blick:

- › Es arbeitet mit Funktechnologie und ermöglicht eine 360-Grad-Steuerung
- › Steuerbar bis zu einer Entfernung von 10 Metern
- › Bis zu 8 verschiedene Artikel können miteinander verbunden werden
- › Einfache Handhabung durch 4 vorgefertigte Einstellungen und 2 Speicherfunktionen

NACHTLICHT

ENTSPANNUNGSMODUS

ARBEITSMODUS

AUSSCHALTEN NACH 30 MINUTEN

Lumière chaude pour se détendre et laisser l'agitation quotidienne derrière soi. Travailler de manière concentrée ou chasser la fatigue, avec une lumière blanche neutre, le niveau d'énergie est rétabli. EGLO Access vous offre ces possibilités et bien d'autres encore. Toutes les fonctions et les points forts en un coup d'œil :

- › Il fonctionne avec la technologie de la fréquence radio et permet un contrôle à 360 degrés
- › Contrôlable jusqu'à une distance de 10 mètres
- › Jusqu'à 8 articles différents peuvent être connectés ensemble
- › Manipulation facile grâce à 4 réglages prêts à l'emploi et 2 fonctions mémoire

VEILLEUSE

MODE DE DÉCOMPRESSION

MODE DE TRAVAIL

EXTINCTION APRÈS 30 MINUTES

COLOUR TEMPERATURES SCALE / FARBTEMPERATUREN SKALA / ÉCHELLE DES TEMPÉRATURES DE COULEUR



REMOTE CONTROL

FERNBEDIENUNG
TÉLÉCOMMANDE

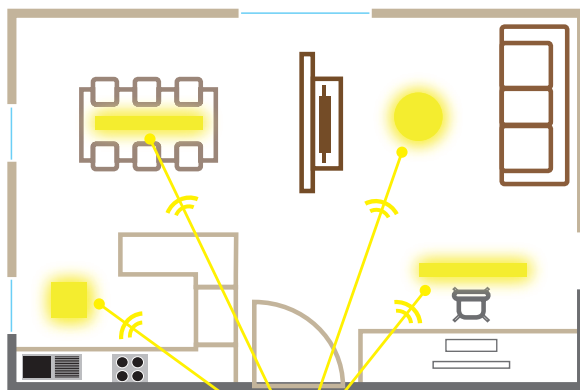

no internet necessary
kein Internet erforderlich
nul besoin d'internet



Control up to 8 EGLO Access luminaires
Bis zu 8 EGLO Access Leuchten steuerbar
Contrôle jusqu'à 8 luminaires EGLO Access



98894

LED

incl./inkl./inclus



33199



incl./inkl./inclus

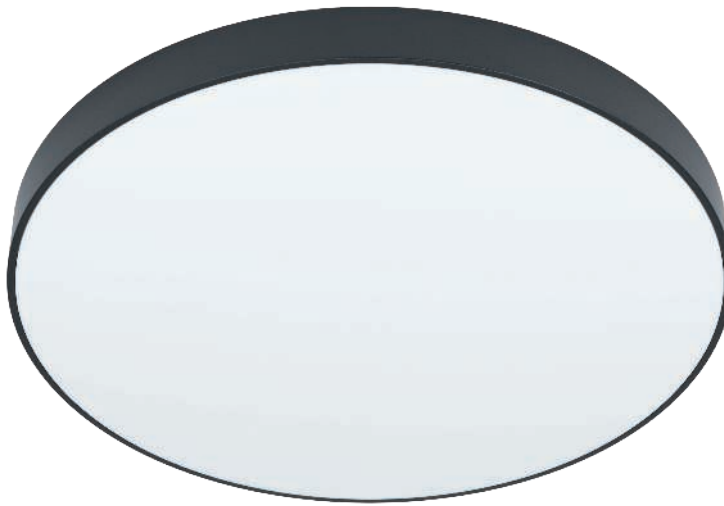

98895

LED

incl./inkl./inclus



33199 ACCESS REMOTE

remote control; plastic, anthracite
Fernbedienung; Kunststoff, anthrazit
Télécommande; plastique, gris anthracite

L 118, B 45



ACCU
CR2032

98894 ZUBIETA-A

surface-mounted light; steel, black / plastic, white
Aufbauleuchte; Stahl, schwarz / Kunststoff, weiss
luminaire en saillie; acier, noir / plastique, blanc

H 40, Ø 300



18W



tunable
WHITE
1900lm



Remote

98895 ZUBIETA-A

surface-mounted light; steel, black / plastic, white
Aufbauleuchte; Stahl, schwarz / Kunststoff, weiss
luminaire en saillie; acier, noir / plastique, blanc

H 40, Ø 450



24W



tunable
WHITE
2300lm



Remote



9 002759 331993



B 45



9 002759 988944



SURFACE



Ø 300



9 002759 988951



SURFACE



Ø 450



98896

LED

incl./inkl./inclus



98896 ZUBIETA-A

surface-mounted light; steel, black / plastic, white
Aufbauleuchte; Stahl, schwarz / Kunststoff, weiss
luminaire en saillie; acier, noir / plastique, blanc

H 40, Ø 595

LED

36W

tunable
WHITE

3700lm



CONTROL
UNIT

Remote



9 002759 988968



SURFACE

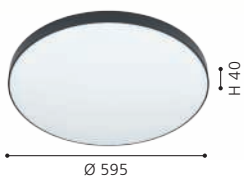



98892



98891



98893



98891 ZUBIETA-A

surface-mounted light; steel, white / plastic, white
Aufbauleuchte; Stahl, weiss / Kunststoff, weiss
luminaire en saillie; acier, blanc / plastique, blanc

H 40, Ø 300



18W



1900lm



Remote

98892 ZUBIETA-A

surface-mounted light; steel, white / plastic, white
Aufbauleuchte; Stahl, weiss / Kunststoff, weiss
luminaire en saillie; acier, blanc / plastique, blanc

H 40, Ø 450



24W



2300lm



Remote

98893 ZUBIETA-A

surface-mounted light; steel, white / plastic, white
Aufbauleuchte; Stahl, weiss / Kunststoff, weiss
luminaire en saillie; acier, blanc / plastique, blanc

H 40, Ø 595



36W



3700lm



Remote



9 002759 988913

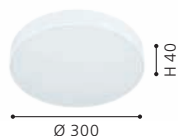

9 002759 988920

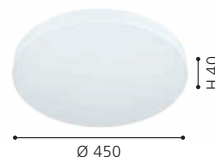

9 002759 988937

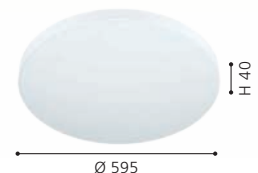



98227



incl./inkl./inclus



98228



incl./inkl./inclus



98227 SILERAS-A

wall / ceiling light; steel, white / plastic with crystal effect, white
Wand- / Deckenleuchte; Stahl, weiss / Kunststoff m. Kristalleffekt, weiss
applique / plafonnier; acier, blanc / plastique avec effet cristal, blanc

H 80, Ø 450



19W



2400lm



Remote

98228 SILERAS-A

wall / ceiling light; steel, white / plastic with crystal effect, white
Wand- / Deckenleuchte; Stahl, weiss / Kunststoff m. Kristalleffekt, weiss
applique / plafonnier; acier, blanc / plastique avec effet cristal, blanc

H 85, Ø 600



36W



3300lm



Remote



9 002759 982270



9 002759 982287





98294

LED

incl./inkl./inclus



98236

LED

incl./inkl./inclus



98237

LED

incl./inkl./inclus



98294 FRANIA-A

wall / ceiling light; steel, white / plastic with crystal effect, white
Wand- / Deckenleuchte; Stahl, weiss / Kunststoff m.Kristalleffekt, weiss
applique / plafonnier; acier, blanc / plastique avec effet cristal, blanc

H 55, Ø 300



12 W



1050 lm



Remote



IP44

98236 FRANIA-A

wall / ceiling light; steel, white / plastic with crystal effect, white
Wand- / Deckenleuchte; Stahl, weiss / Kunststoff m.Kristalleffekt, weiss
applique / plafonnier; acier, blanc / plastique avec effet cristal, blanc

H 55, Ø 400



19 W



2400 lm



Remote

98237 FRANIA-A

wall / ceiling light; steel, white / plastic with crystal effect, white
Wand- / Deckenleuchte; Stahl, weiss / Kunststoff m.Kristalleffekt, weiss
applique / plafonnier; acier, blanc / plastique avec effet cristal, blanc

H 75, Ø 570



32,5 W



3900 lm



Remote



9 002759 982942



Ø 300



9 002759 982362



Ø 400



9 002759 982379



Ø 570



98219

LED



incl./inkl./inclus



98235

LED



incl./inkl./inclus



98235 FRANIA-A

wall / ceiling light; steel, white / plastic, white
Wand- / Deckenleuchte; Stahl, weiss / Kunststoff, weiss
applique / plafonnier; acier, blanc / plastique, blanc

H 55, Ø 300



12W

1050lm

Remote

98219 MORATICA-A

ceiling light; steel, plastic, white, transparent / plastic with
crystal effect, white, silver
Deckenleuchte; Stahl, Kunststoff, weiss, transparent / Kunststoff
m.Kristalleffekt, weiss, silber
plafonnier; acier, plastique, blanc, transparent / plastique avec
effet cristal, blanc, argent
H 75, Ø 570



32,5W

3900lm

Remote



9 002759 982355

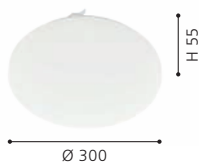

9 002759 982195

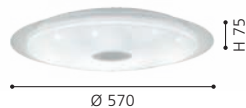



98207



incl./inkl./inclus



98208



incl./inkl./inclus

98207 SARSINA-A

ceiling light; aluminium, white / plastic, white
Deckenleuchte; Alu, weiss / Kunststoff, weiss
plafonnier; aluminium, blanc / plastique, blanc

H 50, Ø 300



14W



2000lm



Remote



98208 SARSINA-A

ceiling light; aluminium, white / plastic, white
Deckenleuchte; Alu, weiss / Kunststoff, weiss
plafonnier; aluminium, blanc / plastique, blanc

H 50, Ø 450



19,5W



2750lm



Remote



98209 SARSINA-A

ceiling light; aluminium, white / plastic, white
Deckenleuchte; Alu, weiss / Kunststoff, weiss
plafonnier; aluminium, blanc / plastique, blanc

H 50, Ø 600



30W



4000lm



Remote



9 002759 982072

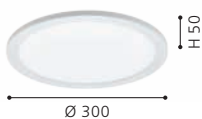

9 002759 982089

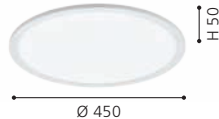

9 002759 982096

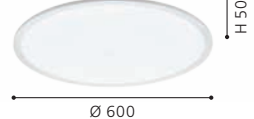



98209

LED

incl./inkl./inclus





98205



98206



98205 SALOBRENA-A

ceiling light; aluminium, white / plastic, white
Deckenleuchte; Alu, weiss / Kunststoff, weiss
plafonnier; aluminium, blanc / plastique, blanc

L 1200, B 300, H 50



98206 SALOBRENA-A

ceiling light; aluminium, white / plastic, white
Deckenleuchte; Alu, weiss / Kunststoff, weiss
plafonnier; aluminium, blanc / plastique, blanc

L 1195, B 100, H 50



98297 SALOBRENA-A

ceiling light; aluminium, white / plastic, white
Deckenleuchte; Alu, weiss / Kunststoff, weiss
plafonnier; aluminium, blanc / plastique, blanc

L 450, B 450, H 50



9 002759 982058



9 002759 982065



9 002759 982973

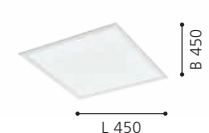



98297



98201



98203



98201 SALOBRENA-A

ceiling light; aluminium, white / plastic, white
Deckenleuchte; Alu, weiss / Kunststoff, weiss
plafonnier; aluminium, blanc / plastique, blanc

L 300, B 300, H 50



98203 SALOBRENA-A

ceiling light; aluminium, white / plastic, white
Deckenleuchte; Alu, weiss / Kunststoff, weiss
plafonnier; aluminium, blanc / plastique, blanc

L 600, B 600, H 50



9 002759 982010

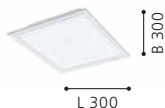

9 002759 982034

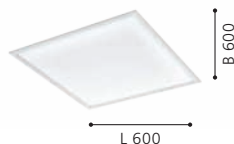



98292



FUEVA-A

These luminaires inspire with their extremely flat and elegant design.

Diese Leuchten begeistern durch ihre extrem flache und elegante Bauweise.

Ces lumières enthousiasment par la méthode de construction extrêmement plate et élégante.



98293



98292 FUEVA-A

surface-mounted light; aluminium, white / plastic, white
 Aufbauleuchte; Alu, weiss / Kunststoff, weiss
 luminaire en saillie; aluminium, blanc / plastique, blanc

H 30, Ø 225



98293 FUEVA-A

surface-mounted light; aluminium, white / plastic, white
 Aufbauleuchte; Alu, weiss / Kunststoff, weiss
 luminaire en saillie; aluminium, blanc / plastique, blanc

H 30, Ø 300



98212 FUEVA-A

recessed light; aluminium, white / plastic, white
 Einbauleuchte; Alu, weiss / Kunststoff, weiss
 luminaire encastrable; aluminium, blanc / plastique, blanc

Ø 120, ET 30





98212

LED

incl./inkl./inclus



LIGHTING FAMILIES

FABRIC LUMINAIRES

STOFFLEUCHTEN

LUMINAIRES À TEXTIL

SIMPLE CLASSINESS

The textile luminaires with their unusual designs are perfectly trendy and bring cosiness to every home. Selected textiles in natural shades and clear shapes form the basis of a friendly and tasteful living environment in our textile luminaires. Inner coatings in sophisticated gold and classical silver add an air of luxury.

SCHLICHTE ELEGANZ

Die Stoffleuchten mit ihrem außergewöhnlichen Design sind voll im Trend und sorgen für Gemütlichkeit in jedem Zuhause. Bei den Stoffleuchten bilden ausgesuchte Stoffe in Naturtönen und klare Formgebungen die Grundlage für eine freundliche und geschmackvolle Wohnumgebung. Für einen Hauch von Luxus sorgen die Innenbeschichtungen in edlem Gold und klassischem Silber.



ÉLÉGANCE SIMPLE

Les luminaires en étoffe avec leur design extraordinaire sont très tendance et assurent un confort dans chaque maison. Chez les luminaires en étoffe, des étoffes sélectionnées dans des tons naturels et des formes claires forment la base d'un cadre de vie convivial et de bon goût. Les revêtements internes en or fin et en argent classique ajoutent une touche de luxe.



OVERVIEW

LIGHTING FAMILIES / FABRIC



This product is available in different colors and shapes./ Dieser Artikel ist in unterschiedlichen Farben und Formen verfügbar.
Cet article est disponible en différentes couleurs et formes.



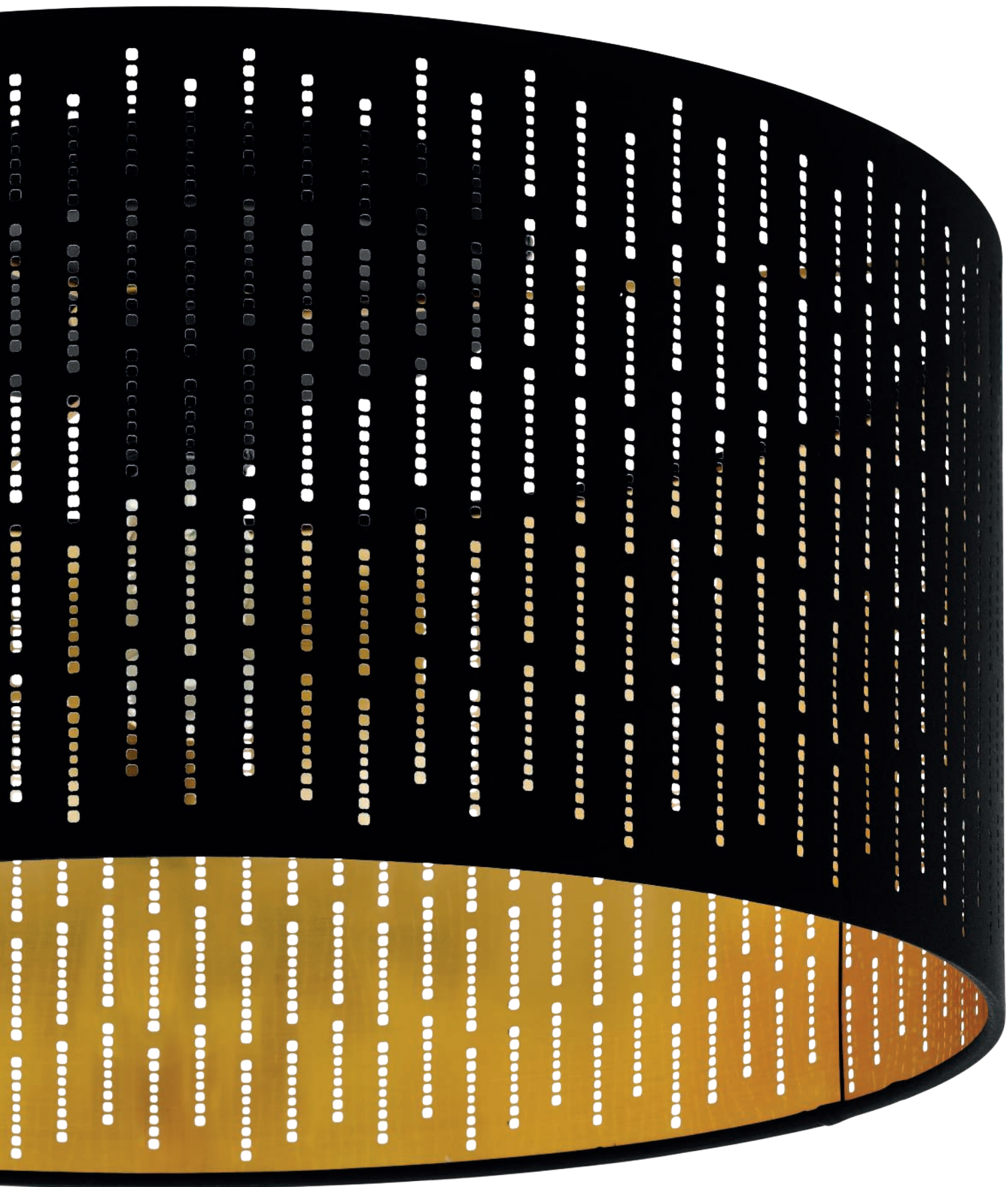

FABRIC MATERIALS

COATING



coating, silver
Beschichtung, silber
revêtement, argent

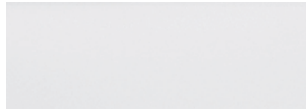

coating, white
Beschichtung, weiß
revêtement, blanc



coating, black
Beschichtung, schwarz
revêtement, noir



coating, gold
Beschichtung, gold
revêtement, or



coating, copper
Beschichtung, kupfer
revêtement, cuivre



coating, brass
Beschichtung, messing
revêtement, laiton



coating, brass & white
Beschichtung, messing & weiß
revêtement, laiton & blanc

SHADES

GLOSSY



fabric, glossy black
Textil, samtglänzend schwarz
tissu, velours noir brillant

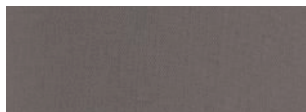

fabric, glossy cappuccino
Textil, samtglänzend cappuccino
tissu, velours cappuccino brillant



fabric, glossy white
Textil, samtglänzend weiß
tissu, velours blanc brillant

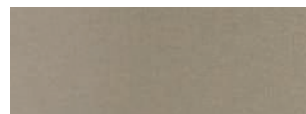

fabric, glossy taupe
Textil, samtglänzend taupe
tissu, velours taupe brillant



fabric, glossy grey
Textil, samtglänzend grau
tissu, velours gris brillant

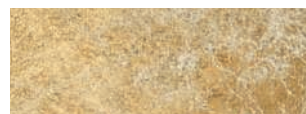

fabric, glossy gold
Textil, samtglänzend gold
tissu, velours or brillant

MAT



fabric, mat black
Textil, matt schwarz
tissu, tapis noir

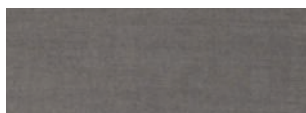

fabric, mat anthracite-brown
Textil, matt anthrazit-braun
tissu, tapis anthracite-marron



fabric, mat white
Textil, matt weiß
tissu, tapis blanc

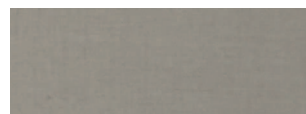

fabric, mat taupe
Textil, matt taupe
tissu, tapis taupe



fabric, mat grey
Textil, matt grau
tissu, tapis gris



fabric, mat white & gold
Textil, matt weiß & gold
tissu, tapis blanc & or

LINEN

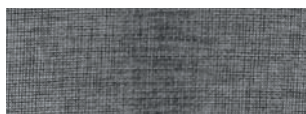

linen, grey
Leinen, grau
lin, gris



linen, brown
Leinen, braun
lin, marron



97777

LED



97782

LED



97779

LED



97777 ROMAO 1

ceiling light; steel, white / fabric, plastic, white
Deckenleuchte; Stahl, weiss / Textil, Kunststoff, weiss
plafonnier; acier, blanc / tissu, plastique, blanc

H 120, Ø 570



36W



4300lm



Remote

97782 ROMAO 1

ceiling light; steel, white / fabric, plastic, white
Deckenleuchte; Stahl, weiss / Textil, Kunststoff, weiss
plafonnier; acier, blanc / tissu, plastique, blanc

H 120, Ø 760



54W



6500lm



Remote

97779 ROMAO

ceiling light; steel, white / fabric linen, plastic, grey, white
Deckenleuchte; Stahl, weiss / Textil Leinen, Kunststoff, grau,
weiss
plafonnier; acier, blanc / tissu de lin, plastique, gris, blanc

H 120, Ø 570



36W



4300lm



Remote



9 002759 977771

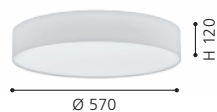

9 002759 977825

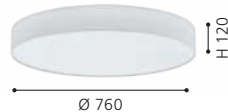

9 002759 977795





97784



incl./inkl./inclus



97783



incl./inkl./inclus



97778



incl./inkl./inclus

TUNABLE WHITE
3000 - 5000 K

DIMMABLE
10 - 100 %

TIMER FUNCTION
off after 30sec.

NIGHT LIGHT FUNCTION

97777	97782
97778	97783
97779	97784

see page / siehe Seite / voir la page 454

97784 ROMAO

ceiling light; steel, white / fabric linen, plastic, grey, white
Deckenleuchte; Stahl, weiss / Textil Leinen, Kunststoff, grau, weiss
plafonnier; acier, blanc / tissu de lin, plastique, gris, blanc

H 120, Ø 760

LED 54 W tunable WHITE 6500lm Remote

97778 ROMAO 3

ceiling light; steel, white / fabric, plastic, taupe, white
Deckenleuchte; Stahl, weiss / Textil, Kunststoff, taupe, weiss
plafonnier; acier, blanc / tissu, plastique, taupe, blanc

H 120, Ø 570

LED 36 W tunable WHITE 4300lm Remote

97783 ROMAO 3

ceiling light; steel, white / fabric, plastic, taupe, white
Deckenleuchte; Stahl, weiss / Textil, Kunststoff, taupe, weiss
plafonnier; acier, blanc / tissu, plastique, taupe, blanc

H 120, Ø 760

LED 54 W tunable WHITE 6500lm Remote



9 002759 977849



9 002759 977788



9 002759 977832





97611 PASTERI

ceiling light; steel, white / fabric, white
Deckenleuchte; Stahl, weiss / Textil, weiss
plafonnier; acier, blanc / tissu, blanc

H 150, Ø 570



97615 PASTERI

ceiling light; steel, white / fabric, white
Deckenleuchte; Stahl, weiss / Textil, weiss
plafonnier; acier, blanc / tissu, blanc

H 150, Ø 760



97619 PASTERI

ceiling light; steel, white / fabric, white
Deckenleuchte; Stahl, weiss / Textil, weiss
plafonnier; acier, blanc / tissu, blanc

H 170, Ø 980





97613



97617



97622

97613 PASTERI

ceiling light; steel, white / fabric, linen, grey, white
Deckenleuchte; Stahl, weiss / Textil, Leinen, grau, weiss
plafonnier; acier, blanc / tissu, lin, gris, blanc

H 150, Ø 570



E27 3x 25W



9 002759 976132



97617 PASTERI

ceiling light; steel, white / fabric, linen, grey, white
Deckenleuchte; Stahl, weiss / Textil, Leinen, grau, weiss
plafonnier; acier, blanc / tissu, lin, gris, blanc

H 150, Ø 760



E27 5x 25W



9 002759 976170



97622 PASTERI

ceiling light; steel, white / fabric, linen, grey, white
Deckenleuchte; Stahl, weiss / Textil, Leinen, grau, weiss
plafonnier; acier, blanc / tissu, lin, gris, blanc

H 170, Ø 980



E27 7x 25W



9 002759 976224





97614



97618



97614 PASTERI

ceiling light; steel, white / fabric, linen, brown, white
Deckenleuchte; Stahl, weiss / Textil, Leinen, braun, weiss
plafonnier; acier, blanc / tissu, lin, marron, blanc

H 150, Ø 570



E27



3x 25W

97618 PASTERI

ceiling light; steel, white / fabric, linen, brown, white
Deckenleuchte; Stahl, weiss / Textil, Leinen, braun, weiss
plafonnier; acier, blanc / tissu, lin, marron, blanc

H 150, Ø 760



E27



5x 25W



9 002759 976149



9 002759 976187





97612 PASTERI

ceiling light; steel, white / fabric, taupe, white
Deckenleuchte; Stahl, weiss / Textil, taupe, weiss
plafonnier; acier, blanc / tissu, taupe, blanc

H 150, Ø 570



97616 PASTERI

ceiling light; steel, white / fabric, taupe, white
Deckenleuchte; Stahl, weiss / Textil, taupe, weiss
plafonnier; acier, blanc / tissu, taupe, blanc

H 150, Ø 760



97621 PASTERI

ceiling light; steel, white / fabric, taupe, white
Deckenleuchte; Stahl, weiss / Textil, taupe, weiss
plafonnier; acier, blanc / tissu, taupe, blanc

H 170, Ø 980





PASTERI SQUARE
POSADERRA



99089



99298

99089 PASTERI SQUARE

ceiling light; steel, white / fabric, plastic, white
Deckenleuchte; Stahl, weiss / Textil, Kunststoff, weiss
plafonnier; acier, blanc / tissu, plastique, blanc

L 575, B 575, H 165



E27



5x 25W

99298 POSADERRA

ceiling light; steel, white / fabric, plastic, white
Deckenleuchte; Stahl, weiss / Textil, Kunststoff, weiss
plafonnier; acier, blanc / tissu, plastique, blanc

L 750, B 280, H 150



E27



3x 28W



9 002759 990893

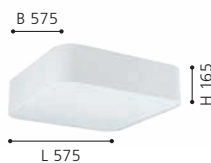

9 002759 992989

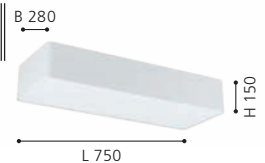



99091



99092

99091 PASTERI SQUARE

ceiling light; steel, white / fabric, plastic, taupe, white
 Deckenleuchte; Stahl, weiss / Textil, Kunststoff, taupe, weiss
 plafonnier; acier, blanc / tissu, plastique, taupe, blanc

L 575, B 575, H 165



E27



5x 25W

99092 PASTERI SQUARE

ceiling light; steel, white / fabric, plastic, grey, white
 Deckenleuchte; Stahl, weiss / Textil, Kunststoff, grau, weiss
 plafonnier; acier, blanc / tissu, plastique, gris, blanc

L 575, B 575, H 165



E27



5x 25W



9 002759 990916

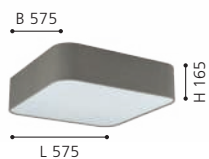

9 002759 990923

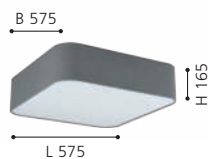



93395

LED



96538

LED



93397

LED

93395 PALOMARO

ceiling light; plastic, white / fabric, anthracite
Deckenleuchte; Kunststoff, weiss / Textil, anthrazit
plafonnier; plastique, blanc / tissu, anthracite

H 90, Ø 320

LED

warm
WHITE
1110lm



3x 3,6W

96538 PALOMARO 1

ceiling light; plastic, white / fabric, anthracite
Deckenleuchte; Kunststoff, weiss / Textil, anthrazit
plafonnier; plastique, blanc / tissu, anthracite

H 100, Ø 405

LED

warm
WHITE
2000lm



18W

93397 PALOMARO

ceiling light; plastic, white / fabric, anthracite
Deckenleuchte; Kunststoff, weiss / Textil, anthrazit
plafonnier; plastique, blanc / tissu, anthracite

H 110, Ø 500

LED

warm
WHITE
2200lm



4x 5,4W



9 002759 933951



9 002759 965389



9 002759 933975

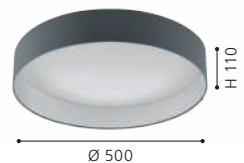



93949



96539



93952



93949 PALOMARO

ceiling light; plastic, white / fabric, taupe
Deckenleuchte; Kunststoff, weiss / Textil, taupe
plafonnier; plastique, blanc / tissu, taupe

H 90, Ø 320



3x 3,6W 1110lm

96539 PALOMARO 1

ceiling light; plastic, white / fabric, taupe
Deckenleuchte; Kunststoff, weiss / Textil, taupe
plafonnier; plastique, blanc / tissu, taupe

H 100, Ø 405



18W 2000lm

93952 PALOMARO

ceiling light; plastic, white / fabric, taupe
Deckenleuchte; Kunststoff, weiss / Textil, taupe
plafonnier; plastique, blanc / tissu, taupe

H 110, Ø 500



4x 5,4W 2200lm



9 002759 939496



9 002759 965396



9 002759 939526





97479



97838



98409

97479 PASTORE

ceiling light; steel, white / fabric, anthracite-brown, white, grey
Deckenleuchte; Stahl, weiss / Textil, anthrazit-braun, weiss, grau
plafonnier; acier, blanc / tissu, marron anthracite, blanc, gris

L 610, B 495, H 255



E27



3x 60W

97838 PASTORE

ceiling light; steel, white / fabric, brown, grey, white, black
Deckenleuchte; Stahl, weiss / Textil, braun, grau, weiss, schwarz
plafonnier; acier, blanc / tissu, marron, gris, blanc, noir

H 285, Ø 990



E27



6x 40W

98409 PASTORE 1

ceiling light; steel, white / fabric, taupe
Deckenleuchte; Stahl, weiss / Textil, taupe
plafonnier; acier, blanc / tissu, taupe

H 250, Ø 990



E27



6x 40W



9 002759 974794

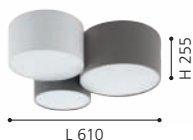

9 002759 978389

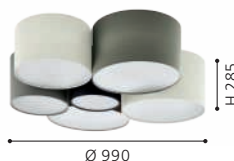

9 002759 984090





99508



99509



PASTORE | PASTORE 1
PASTORE 2

99508 PASTORE 2

ceiling light; steel, white / fabric, black, white
Deckenleuchte; Stahl, weiss / Textil, schwarz, weiss
plafonnier; acier, blanc / tissu, noir, blanc

L 610, B 495, H 255



E27



3x 60W



9 002759 995089

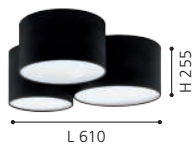

99509 PASTORE 2

ceiling light; steel, white / fabric, black, white
Deckenleuchte; Stahl, weiss / Textil, schwarz, weiss
plafonnier; acier, blanc / tissu, noir, blanc

H 285, Ø 990



E27



6x 40W



9 002759 995096

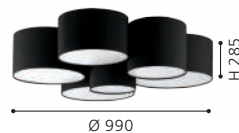

DESIGN
HIGHLIGHT
DETAIL



31581



31572

31581 PASTERI

pendant light; steel, satin nickel / fabric, taupe
 Hängeleuchte; Stahl, nickel-matt / Textil, taupe
 luminaire en suspension; acier, nickel mat / tissu, taupe

L 750, B 220, H 1100

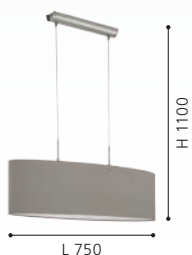
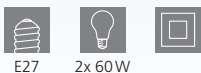

31572 PASTERI

pendant light; steel, satin nickel / fabric, taupe
 Hängeleuchte; Stahl, nickel-matt / Textil, taupe
 luminaire en suspension; acier, nickel mat / tissu, taupe

H 1100, Ø 380



31589 PASTERI

ceiling light; plastic, steel, white / fabric, taupe
 Deckenleuchte; Kunststoff, Stahl, weiss / Textil, taupe
 plafonnier; plastique, acier, blanc / tissu, taupe

H 90, Ø 320





31589

LED



31576

31576 PASTERI

pendant light; steel, satin nickel / fabric, taupe
Hängeleuchte; Stahl, nickel-matt / Textil, taupe
luminaire en suspension; acier, nickel mat / tissu, taupe

H 1100, Ø 530



E27



1x 60W



9 002759 315764





94919



94919



94925



96478



94919 PASTERI

ceiling light; steel, satin nickel / fabric, glass, taupe
Deckenleuchte; Stahl, nickel-matt / Textil, Glas, taupe
plafonnier; acier, nickel mat / tissu, verre, taupe

H 195, Ø 475



E27 3x 25W



9 002759 949198



94925 PASTERI

wall light; steel, satin nickel / fabric, taupe
Wandleuchte; Stahl, nickel-matt / Textil, taupe
applique; acier, nickel mat / tissu, taupe

L 145, H 305, A 195

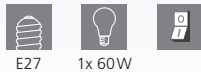

E27 1x 60W



9 002759 949259



96478 PASTERI

wall light; steel, satin nickel / fabric, taupe
Wandleuchte; Stahl, nickel-matt / Textil, taupe
applique; acier, nickel mat / tissu, taupe

L 150, H 380, A 195



E27 1x 40W 1x 3,8W 320lm



9 002759 964788

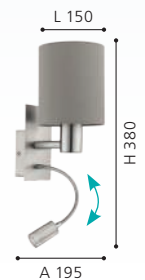



95122



95122

These luminaires can be switched on and off by touching the specially designed "Touch Me" part of the fixture.

Diese Leuchten können ein- und ausgeschaltet werden, indem man sie an den dafür vorgesehenen "Touch Me" Bereichen berührt.

Ces luminaires peuvent être éteints et allumés simplement en touchant la partie spécialement conçue pour "Touch Me" du luminaire.



31595



95167

95122 PASTERI

table light; steel, satin nickel / fabric, taupe
Tischleuchte; Stahl, nickel-matt / Textil, taupe
luminaire de table; acier, nickel mat / tissu, taupe

H 255, Ø 120



E27 1x 40W



9 002759 951221



31595 PASTERI

table light; steel, satin nickel / fabric, taupe
Tischleuchte; Stahl, nickel-matt / Textil, taupe
luminaire de table; acier, nickel mat / tissu, taupe

H 400, Ø 180



E27 1x 60W



9 002759 315955



95167 PASTERI

floor light; steel, satin nickel / fabric, taupe
Stehleuchte; Stahl, nickel-matt / Textil, taupe
lampadaire; acier, nickel mat / tissu, taupe

H 1575, Ø 280, Base: Ø 230



E27 1x 60W



9 002759 951672

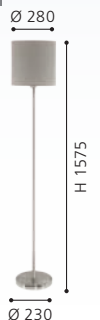



31582



31592

LED



31586

31582 PASTERI

pendant light; steel, satin nickel / fabric, grey
 Hängeleuchte; Stahl, nickel-matt / Textil, grau
 luminaire en suspension; acier, nickel mat / tissu, gris

L 750, B 220, H 1100

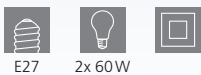

E27 2x 60W



9 002759 315825

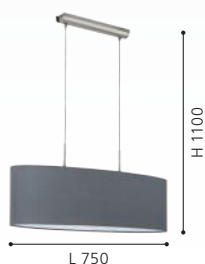

31586 PASTERI

pendant light; steel, satin nickel / fabric, grey
 Hängeleuchte; Stahl, nickel-matt / Textil, grau
 luminaire en suspension; acier, nickel mat / tissu, gris

L 1000, B 280, H 1100

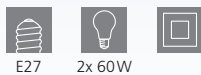

E27 2x 60W



9 002759 315863



31592 PASTERI

ceiling light; plastic, steel, white / fabric, grey
 Deckenleuchte; Kunststoff, Stahl, weiss / Textil, grau
 plafonnier; plastique, acier, blanc / tissu, gris

H 90, Ø 320



LED warm WHITE 3x 3,6W 1110lm



9 002759 315924





94921 PASTERI

ceiling light; steel, satin nickel / fabric, glass, grey
Deckenleuchte; Stahl, nickel-matt / Textil, Glas, grau
plafonnier; acier, nickel mat / tissu, verre, gris

H 195, Ø 475

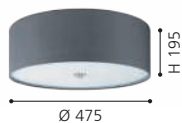

31577 PASTERI

pendant light; steel, satin nickel / fabric, grey
Hängeleuchte; Stahl, nickel-matt / Textil, grau
luminaire en suspension; acier, nickel mat / tissu, gris

H 1100, Ø 530



31573 PASTERI

pendant light; steel, satin nickel / fabric, grey
Hängeleuchte; Stahl, nickel-matt / Textil, grau
luminaire en suspension; acier, nickel mat / tissu, gris

H 1100, Ø 380





94926



96479

LED

94926 PASTERI

wall light; steel, satin nickel / fabric, grey
 Wandleuchte; Stahl, nickel-matt / Textil, grau
 applique; acier, nickel mat / tissu, gris

L 145, H 305, A 195



96479 PASTERI

wall light; steel, satin nickel / fabric, grey
 Wandleuchte; Stahl, nickel-matt / Textil, grau
 applique; acier, nickel mat / tissu, gris

L 150, H 380, A 195

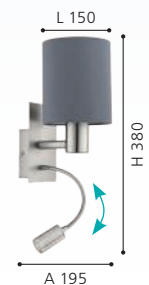



95119



95119

These luminaires can be switched on and off by touching the specially designed "Touch Me" part of the fixture.

Diese Leuchten können ein- und ausgeschaltet werden, indem man sie an den dafür vorgesehenen "Touch Me" Bereichen berührt.

Ces luminaires peuvent être éteints et allumés simplement en touchant la partie spécialement conçue pour "Touch Me" du luminaire.



31596



95166

95119 PASTERI

table light; steel, satin nickel / fabric, grey
Tischleuchte; Stahl, nickel-matt / Textil, grau
luminaire de table; acier, nickel mat / tissu, gris

H 255, Ø 120



E27 1x 40W



9 002759 951191



31596 PASTERI

table light; steel, satin nickel / fabric, grey
Tischleuchte; Stahl, nickel-matt / Textil, grau
luminaire de table; acier, nickel mat / tissu, gris

H 400, Ø 180

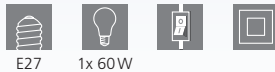

E27 1x 60W



9 002759 315962



95166 PASTERI

floor light; steel, satin nickel / fabric, grey
Stehleuchte; Stahl, nickel-matt / Textil, grau
lampadaire; acier, nickel mat / tissu, gris

H 1575, Ø 280, Base: Ø 230



E27 1x 60W



9 002759 951665





31578



96481

The main and reading lights can be switched on separately.

Das Haupt- und das Leselicht können getrennt voneinander geschaltet werden.

Les luminaires principales et de lecture peuvent être allumées séparément.



96481

LED

31578 PASTERI

pendant light; steel, satin nickel / fabric, anthracite-brown
Hängeleuchte; Stahl, nickel-matt / Textil, anthrazit-braun
luminaire en suspension; acier, nickel mat / tissu, marron anthracite

H 1100, Ø 530

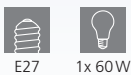

E27 1x 60W



9 002759 315788



31574 PASTERI

pendant light; steel, satin nickel / fabric, anthracite-brown
Hängeleuchte; Stahl, nickel-matt / Textil, anthrazit-braun
luminaire en suspension; acier, nickel mat / tissu, marron anthracite

H 1100, Ø 380



E27 1x 60W



9 002759 315740



96481 PASTERI

wall light; steel, satin nickel / fabric, anthracite-brown
Wandleuchte; Stahl, nickel-matt / Textil, anthrazit-braun
applique; acier, nickel mat / tissu, marron anthracite

L 150, H 380, A 195



E27 1x 40W 1x 3,8W 320lm



9 002759 964818

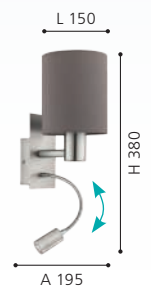



31579



31575



31579 PASTERI

pendant light; steel, satin nickel / fabric, white
 Hängeleuchte; Stahl, nickel-matt / Textil, weiss
 luminaire en suspension; acier, nickel mat / tissu, blanc

L 750, B 220, H 1100

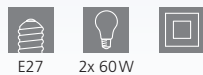

31575 PASTERI

pendant light; steel, satin nickel / fabric, white
 Hängeleuchte; Stahl, nickel-matt / Textil, weiss
 luminaire en suspension; acier, nickel mat / tissu, blanc

H 1100, Ø 530





31571



94918



31588

LED



94918

31571 PASTERI

pendant light; steel, satin nickel / fabric, white
Hängeleuchte; Stahl, nickel-matt / Textil, weiss
luminaire en suspension; acier, nickel mat / tissu, blanc

H 1100, Ø 380



9 002759 315719



31588 PASTERI

ceiling light; plastic, steel, white / fabric, white
Deckenleuchte; Kunststoff, Stahl, weiss / Textil, weiss
plafonnier; plastique, acier, blanc / tissu, blanc

H 90, Ø 320



3x 3,6W 1110lm



9 002759 315887



94918 PASTERI

ceiling light; steel, satin nickel / fabric, glass, white
Deckenleuchte; Stahl, nickel-matt / Textil, Glas, weiss
plafonnier; acier, nickel mat / tissu, verre, blanc

H 195, Ø 475



9 002759 949181





94924



95118



96477

LED

95118

These luminaires can be switched on and off by touching the specially designed "Touch Me" part of the fixture.

Diese Leuchten können ein- und ausgeschaltet werden, indem man sie an den dafür vorgesehenen "Touch Me" Bereichen berührt.

Ces luminaires peuvent être éteints et allumés simplement en touchant la partie spécialement conçue pour "Touch Me" du luminaire.



96477 PASTERI

wall light; steel, satin nickel / fabric, white
Wandleuchte; Stahl, nickel-matt / Textil, weiss
applique; acier, nickel mat / tissu, blanc

L 150, H 380, A 195

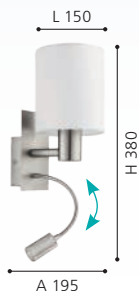

94924 PASTERI

wall light; steel, satin nickel / fabric, white
Wandleuchte; Stahl, nickel-matt / Textil, weiss
applique; acier, nickel mat / tissu, blanc

L 145, H 305, A 195



95118 PASTERI

table light; steel, satin nickel / fabric, white
Tischleuchte; Stahl, nickel-matt / Textil, weiss
luminaire de table; acier, nickel mat / tissu, blanc

H 255, Ø 120

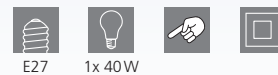



31594



95164

31594 PASTERI

table light; steel, satin nickel / fabric, white
Tischleuchte; Stahl, nickel-matt / Textil, weiss
luminaire de table; acier, nickel mat / tissu, blanc

H 400, Ø 180



E27 1x 60W



9 002759 315948



95164 PASTERI

floor light; steel, satin nickel / fabric, white
Stehleuchte; Stahl, nickel-matt / Textil, weiss
lampadaire; acier, nickel mat / tissu, blanc

H 1575, Ø 280, Base: Ø 230



E27 1x 60W



9 002759 951641





95044



95045



95044 PASTERI

pendant light; steel, satin nickel / fabric, white, copper
 Hängeleuchte; Stahl, nickel-matt / Textil, weiss, kupfer
 luminaire en suspension; acier, nickel mat / tissu, blanc, cuivre

H 1100, Ø 380



E27



1x 60W



9 002759 950446



95045 PASTERI

pendant light; steel, satin nickel / fabric, white, copper
 Hängeleuchte; Stahl, nickel-matt / Textil, weiss, kupfer
 luminaire en suspension; acier, nickel mat / tissu, blanc, cuivre

H 1100, Ø 530



E27



1x 60W



9 002759 950453





96483



96484



96483 PASTERI

wall light; steel, satin nickel / fabric, black, copper
Wandleuchte; Stahl, nickel-matt / Textil, schwarz, kupfer
applique; acier, nickel mat / tissu, noir, cuivre

L 150, H 380, A 195



E27



1x 40W



1x 3,8W



320lm



9 002759 964832

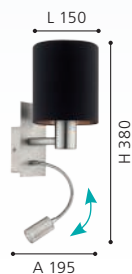

96484 PASTERI

wall light; steel, satin nickel / fabric, white, copper
Wandleuchte; Stahl, nickel-matt / Textil, weiss, kupfer
applique; acier, nickel mat / tissu, blanc, cuivre

L 150, H 380, A 195



E27



1x 40W



1x 3,8W



320lm



9 002759 964849



96483, 96484

The main and reading lights can be switched on separately.

Das Haupt- und das Leselicht können getrennt voneinander geschaltet werden.

Les luminaires principales et de lecture peuvent être allumées séparément.



97643



97644

97643 VISERBELLA

pendant light; steel, champagne / fabric, gold
 Hängeleuchte; Stahl, champagner / Textil, gold
 luminaire en suspension; acier, champagne / tissu, doré

H 1100, Ø 380

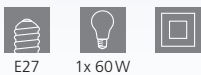

9 002759 976439



97644 VISERBELLA

pendant light; steel, champagne / fabric, gold
 Hängeleuchte; Stahl, champagner / Textil, gold
 luminaire en suspension; acier, champagne / tissu, doré

H 1100, Ø 530



9 002759 976446



97641 VISERBELLA

ceiling light; steel, champagne / fabric, gold
 Deckenleuchte; Stahl, champagner / Textil, gold
 plafonnier; acier, champagne / tissu, doré

H 110, Ø 380



9 002759 976415





97641



97642



97641 | 97642



97642 VISERBELLA

ceiling light; steel, champagne / fabric, gold
Deckenleuchte; Stahl, champagner / Textil, gold
plafonnier; acier, champagne / tissu, doré

H 195, Ø 470

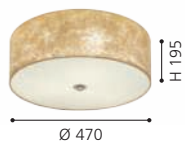



DESIGN
HIGHLIGHT
DETAIL



97645



97647

97645 VISERBELLA

wall light; steel, champagne / fabric, gold
Wandleuchte; Stahl, champagner / Textil, gold
applique; acier, champagne / tissu, doré

L 145, H 305, A 195



E27

1x 60W



9 002759 976453



97647 VISERBELLA

floor light; steel, champagne / fabric, gold
Stehleuchte; Stahl, champagner / Textil, gold
lampadaire; acier, champagne / tissu, doré

H 1585, Ø 280, Base: Ø 230



E27

1x 60W



9 002759 976477



97646 VISERBELLA

table light; steel, champagne / fabric, gold
Tischleuchte; Stahl, champagner / Textil, gold
luminaire de table; acier, champagne / tissu, doré

H 400, Ø 180, Base: Ø 150



E27

1x 60W



9 002759 976460





97646



DESIGN
HIGHLIGHT
DETAIL



99273 ESTEPERRA

pendant light; steel, black / fabric, black, gold
Hängeleuchte; Stahl, schwarz / Textil, schwarz, gold
luminaire en suspension; acier, noir / tissu, noir, or

H 1100, Ø 380



99272 ESTEPERRA

ceiling light; steel, black / fabric, black, gold
Deckenleuchte; Stahl, schwarz / Textil, schwarz, gold
plafonnier; acier, noir / tissu, noir, or

H 240, Ø 475

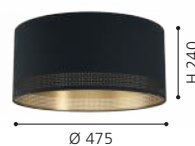

99274 ESTEPERRA

pendant light; steel, black / fabric, black, gold
Hängeleuchte; Stahl, schwarz / Textil, schwarz, gold
luminaire en suspension; acier, noir / tissu, noir, or

H 1100, Ø 530

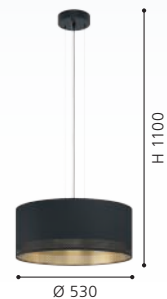



99274



99279

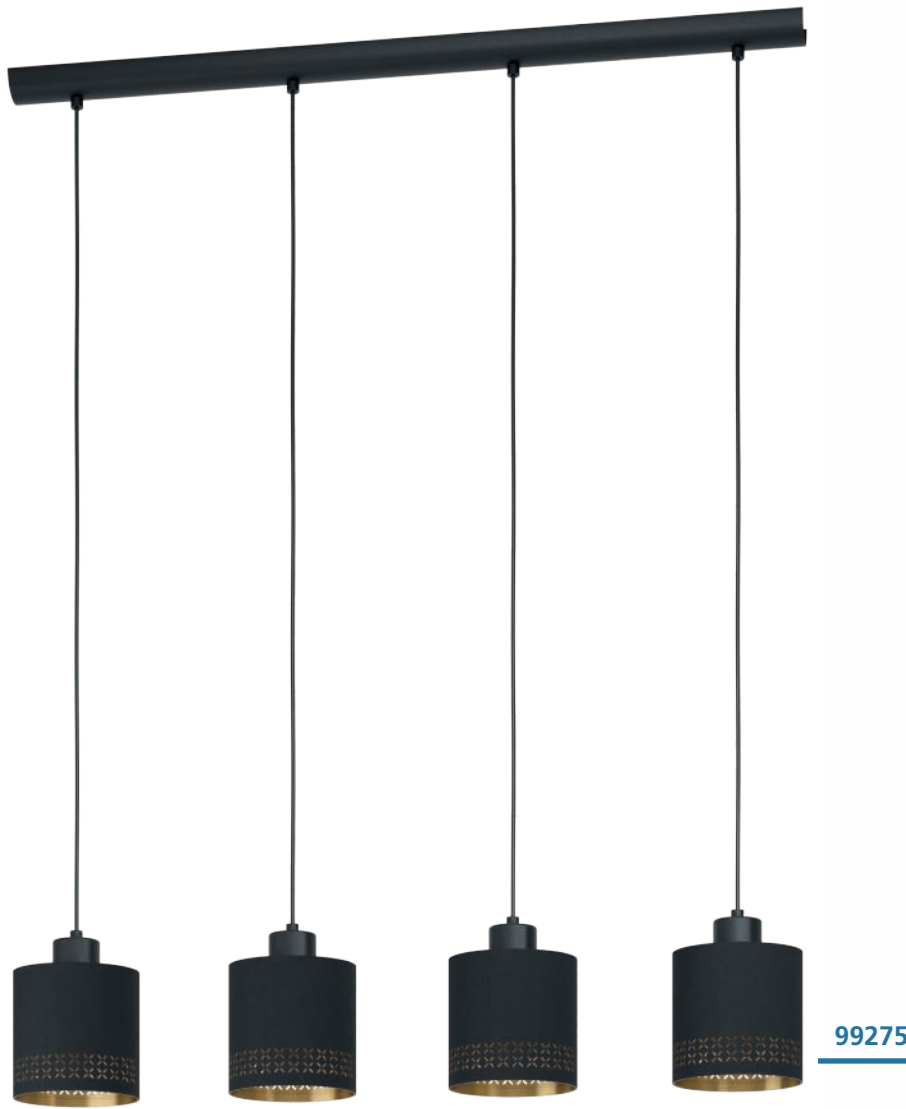

DESIGN
HIGHLIGHT
DETAIL



99279 ESTEPERRA

floor light; steel, black / fabric, black, gold
Stehleuchte; Stahl, schwarz / Textil, schwarz, gold
lampadaire; acier, noir / tissu, noir, or

H 1405, Ø 380, Base: Ø 645



E27 1x 40W



9 002759 992798

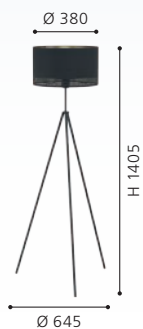

99275 ESTEPERRA

pendant light; steel, black / fabric, black, gold
Hängeleuchte; Stahl, schwarz / Textil, schwarz, gold
luminaire en suspension; acier, noir / tissu, noir, or

L 940, B 160, H 1100



E27 4x 28W



9 002759 992750





98313

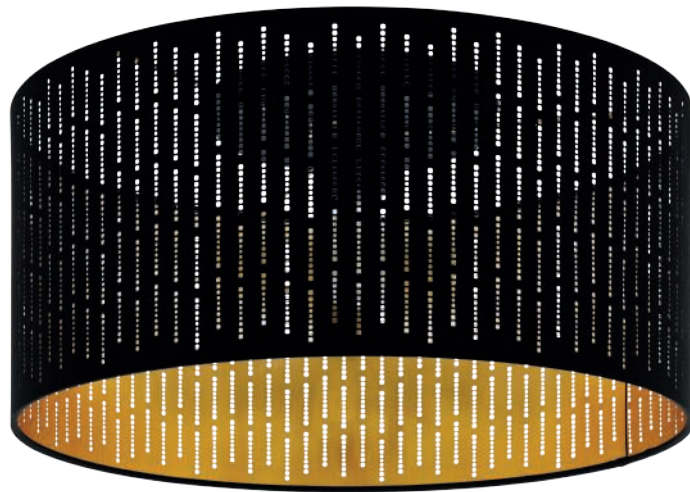

98311



98314



98313 VARILLAS

pendant light; steel, black / fabric with cut-outs, black, gold
Hängeleuchte; Stahl, schwarz / Textil mit Ausstanzungen, schwarz, gold

luminaire en suspension; acier, noir / tissu avec découpes, noir, or

H 1100, Ø 530



E27 3x 40W



9 002759 983130



98311 VARILLAS

ceiling light; steel, black / fabric with cut-outs, black, gold
Deckenleuchte; Stahl, schwarz / Textil mit Ausstanzungen, schwarz, gold

plafonnier; acier, noir / tissu avec découpes, noir, or

H 240, Ø 475



E27 1x 40W



9 002759 983116

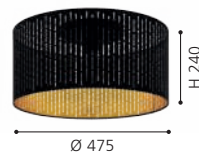

98314 VARILLAS

table light; steel, black / fabric with cut-outs, black, gold
Tischleuchte; Stahl, schwarz / Textil mit Ausstanzungen, schwarz, gold

luminaire de table; acier, noir / tissu avec découpes, noir, or

H 255, Ø 120

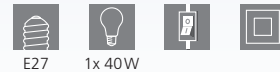

E27 1x 40W



9 002759 983147

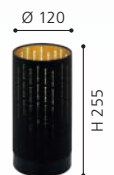



99613

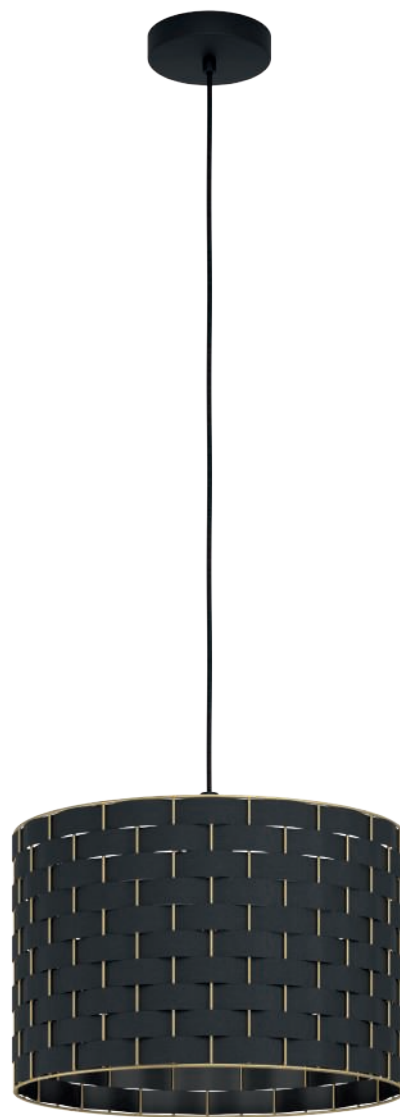

99524

99613 MARASALES

pendant light; steel, black / fabric, black, brass
 Hängeleuchte; Stahl, schwarz / Textil, schwarz, messing
 luminaire en suspension; acier, noir / tissu, noir, laiton

L 780, B 220, H 1100

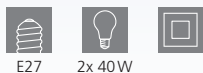

E27 2x 40W



9 002759 996130

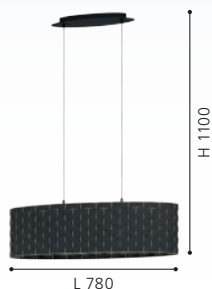

99524 MARASALES

pendant light; steel, black / fabric, black, brass
 Hängeleuchte; Stahl, schwarz / Textil, schwarz, messing
 luminaire en suspension; acier, noir / tissu, noir, laiton

H 1100, Ø 380



E27 1x 40W



9 002759 995249



99525 MARASALES

pendant light; steel, black / fabric, black, brass
 Hängeleuchte; Stahl, schwarz / Textil, schwarz, messing
 luminaire en suspension; acier, noir / tissu, noir, laiton

H 1100, Ø 550



E27 1x 40W



9 002759 995256



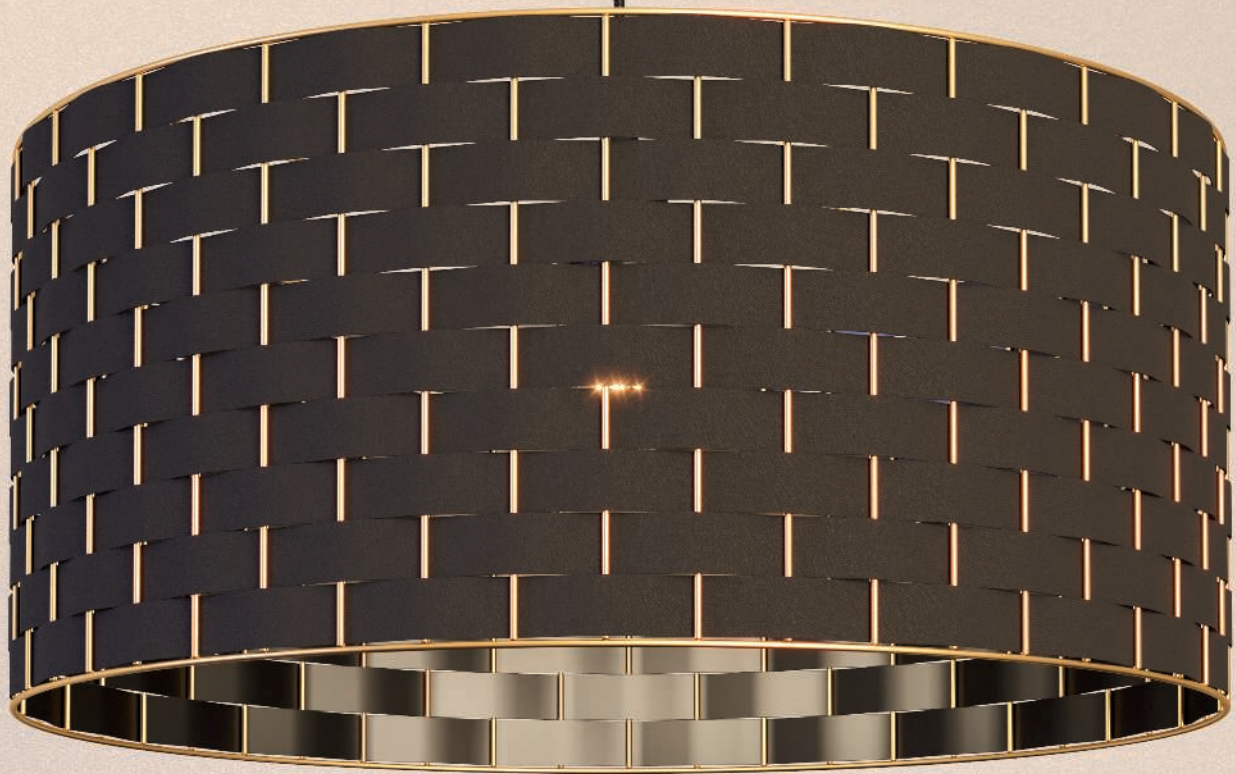

99525





99523

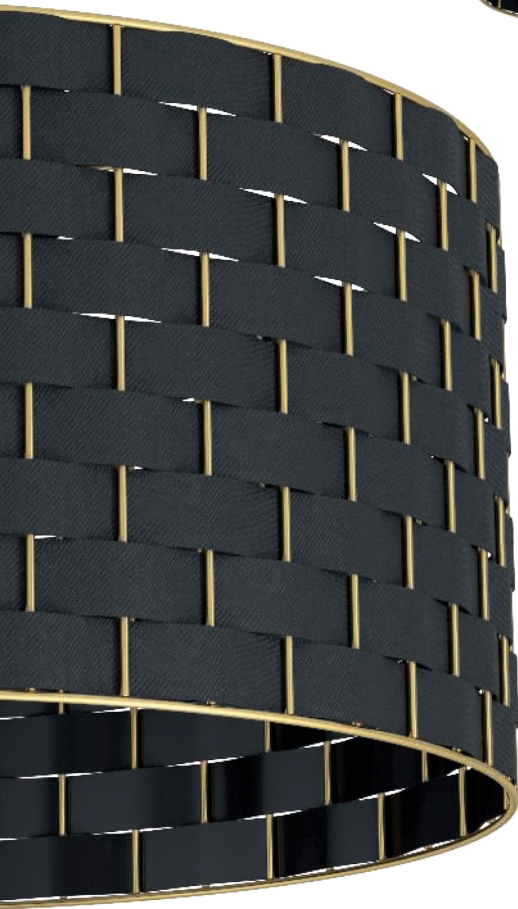

99526

99523 MARASALES

ceiling light; steel, black / fabric, black, brass
Deckenleuchte; Stahl, schwarz / Textil, schwarz, messing
plafonnier; acier, noir / tissu, noir, laiton

H 250, Ø 480



E27 1x 40W

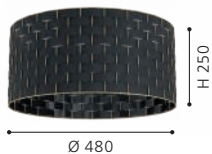

99526 MARASALES

table light; steel, black / fabric, black, brass
Tischleuchte; Stahl, schwarz / Textil, schwarz, messing
luminaire de table; acier, noir / tissu, noir, laiton

H 570, Ø 280



E27 1x 40W



99527 MARASALES

floor light; steel, black / fabric, black, brass
Stehleuchte; Stahl, schwarz / Textil, schwarz, messing
lampadaire; acier, noir / tissu, noir, laiton

H 1490, Ø 450, Base: Ø 745

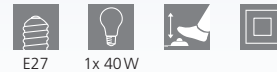

E27 1x 40W





99527



900145



900144

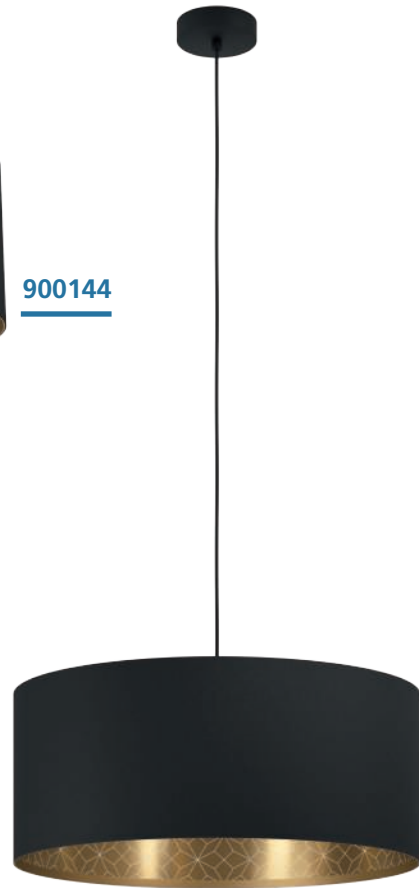

900146

900145 ZARAGOZA

pendant light; steel, black / fabric with decor, black, gold
Hängeleuchte; Stahl, schwarz / Textil mit Dekor, schwarz, gold
luminaire en suspension; acier, noir / tissu avec décor, noir, or

H 1100, Ø 380



E27 1x 40W



9 008606 235384



900144 ZARAGOZA

ceiling light; steel, black / fabric with decor, black, gold
Deckenleuchte; Stahl, schwarz / Textil mit Dekor, schwarz, gold
plafonnier; acier, noir / tissu avec décor, noir, or

H 240, Ø 475



E27 1x 40W



9 008606 235377

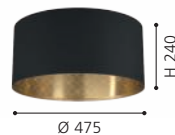

900146 ZARAGOZA

pendant light; steel, black / fabric with decor, black, gold
Hängeleuchte; Stahl, schwarz / Textil mit Dekor, schwarz, gold
luminaire en suspension; acier, noir / tissu avec décor, noir, or

H 1100, Ø 530

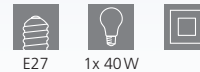

E27 1x 40W



9 008606 235391

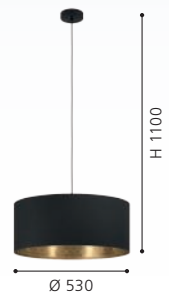

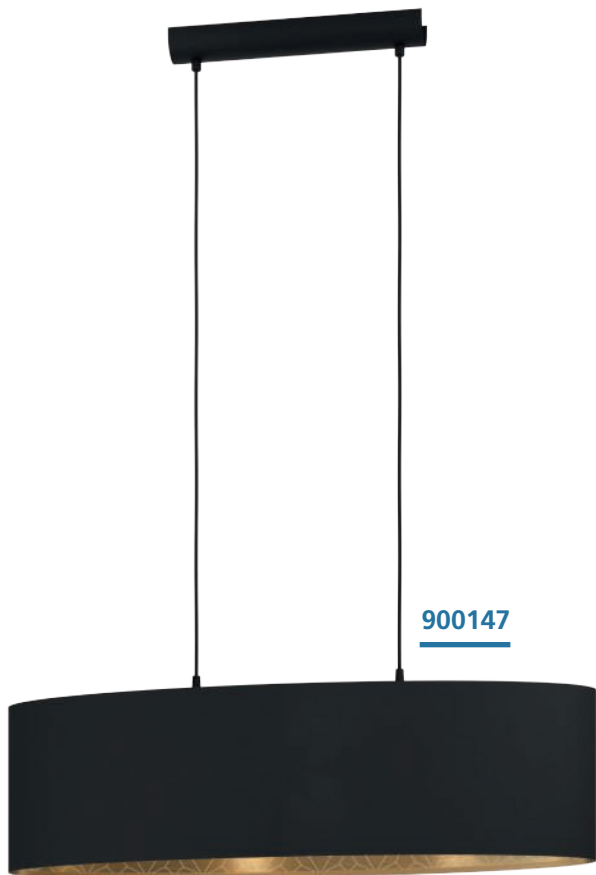

900147

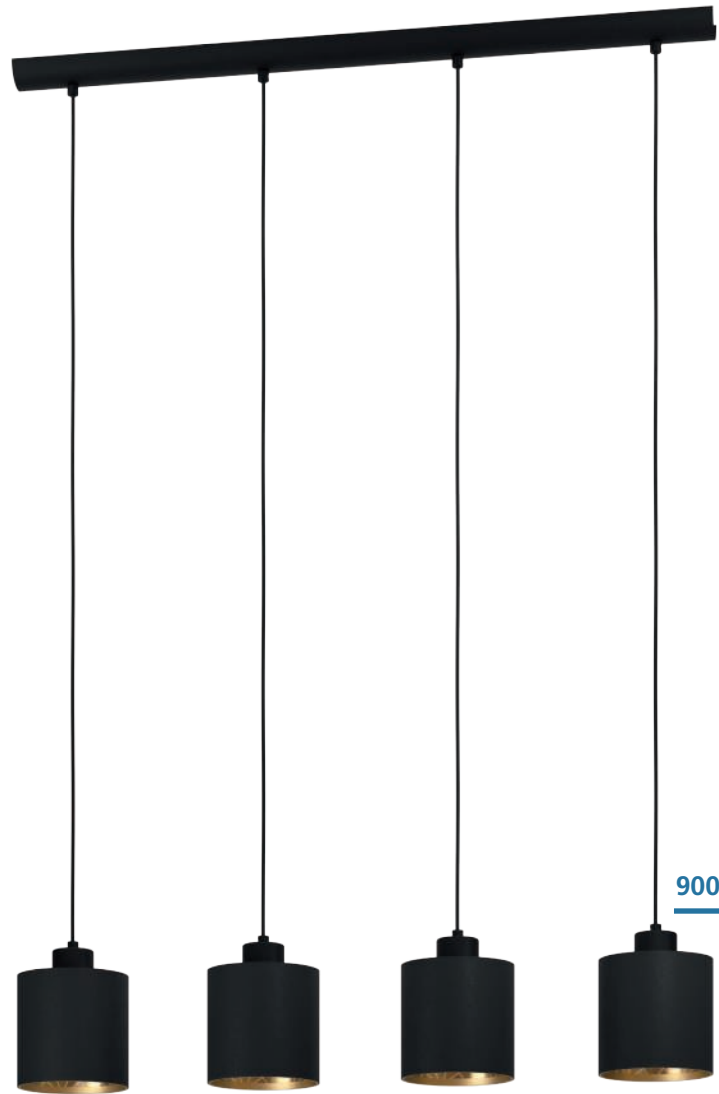

900148

900147 ZARAGOZA

pendant light; steel, black / fabric with decor, black, gold
 Hängeleuchte; Stahl, schwarz / Textil mit Dekor, schwarz, gold
 luminaire en suspension; acier, noir / tissu avec décor, noir, or

L 780, B 220, H 1100

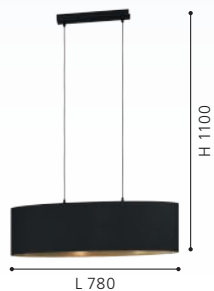

900148 ZARAGOZA

pendant light; steel, black / fabric with decor, black, gold
 Hängeleuchte; Stahl, schwarz / Textil mit Dekor, schwarz, gold
 luminaire en suspension; acier, noir / tissu avec décor, noir, or

L 925, B 160, H 1100

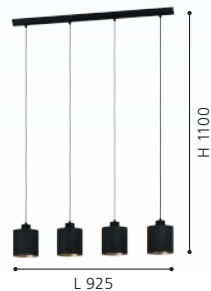



900634

900634 BUCAMARANGA

ceiling light; steel, white / fabric with decor, white, gold
 Deckenleuchte; Stahl, weiss / Textil mit Dekor, weiss, gold
 plafonnier; acier, blanc / tissu avec décor, blanc, or

H 240, Ø 475



9 008606 241200



900635 BUCAMARANGA

pendant light; steel, white / fabric with decor, white, gold
 Hängeleuchte; Stahl, weiss / Textil mit Dekor, weiss, gold
 luminaire en suspension; acier, blanc / tissu avec décor, blanc, or

H 1100, Ø 530



9 008606 241217





900635





31601



99543

LED

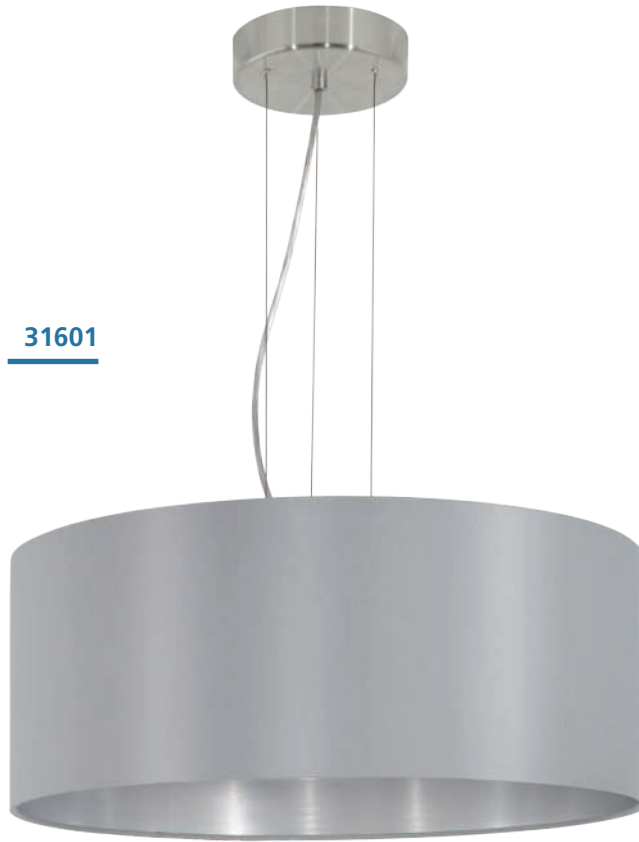

31606

31601 MASERLO

pendant light; steel, satin nickel / fabric, grey, silver
 Hängeleuchte; Stahl, nickel-matt / Textil, grau, silber
 luminaire en suspension; acier, nickel mat / tissu, gris, argent

H 1100, Ø 380

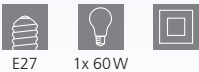

9 002759 316013

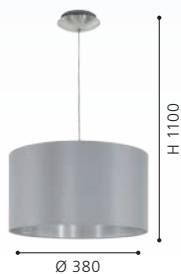

31606 MASERLO

pendant light; steel, satin nickel / fabric, grey, silver
 Hängeleuchte; Stahl, nickel-matt / Textil, grau, silber
 luminaire en suspension; acier, nickel mat / tissu, gris, argent

H 1100, Ø 530



9 002759 316068



99543 MASERLO 2

ceiling light; plastic, steel, white / fabric, grey, silver
 Deckenleuchte; Kunststoff, Stahl, weiss / Textil, grau, silber
 plafonnier; plastique, acier, blanc / tissu, gris, argent

H 90, Ø 380



9 002759 995430

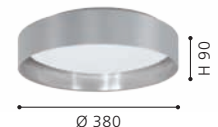



31628

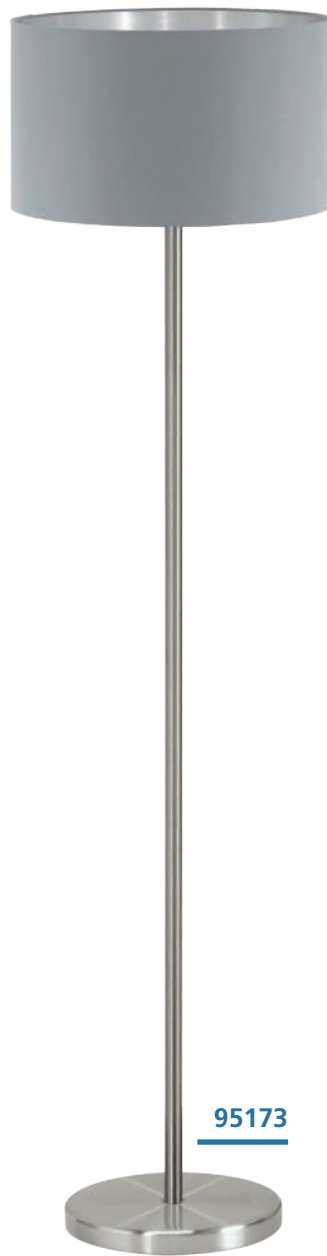

95173



31628 MASERLO

table light; steel, satin nickel / fabric, grey, silver
Tischleuchte; Stahl, nickel-matt / Textil, grau, silber
luminaire de table; acier, nickel mat / tissu, gris, argent

H 420, Ø 230

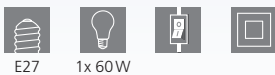

E27 1x 60W



9 002759 316280



95173 MASERLO

floor light; steel, satin nickel / fabric, grey, silver
Stehleuchte; Stahl, nickel-matt / Textil, grau, silber
lampadaire; acier, nickel mat / tissu, gris, argent

H 1510, Ø 380, Base: Ø 250



E27 1x 60W



9 002759 951733

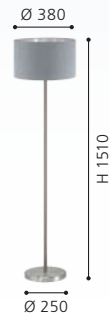



99044



99042



99043



MASERLO 1

99044 MASERLO 1

pendant light; steel, black / fabric, black
 Hängeleuchte; Stahl, schwarz / Textil, schwarz
 luminaire en suspension; acier, noir / tissu, noir

L 780, B 220, H 1100

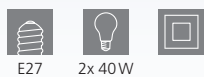

E27 2x 40W



9 002759 990442

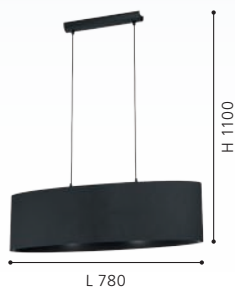

99042 MASERLO 1

pendant light; steel, black / fabric, black
 Hängeleuchte; Stahl, schwarz / Textil, schwarz
 luminaire en suspension; acier, noir / tissu, noir

H 1100, Ø 380

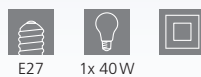

E27 1x 40W



9 002759 990428

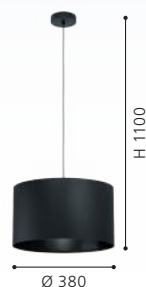

99043 MASERLO 1

pendant light; steel, black / fabric, black
 Hängeleuchte; Stahl, schwarz / Textil, schwarz
 luminaire en suspension; acier, noir / tissu, noir

H 1100, Ø 530

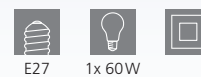

E27 1x 60W



9 002759 990435





DESIGN
HIGHLIGHT
DETAIL



99041



MASERLO 1



99045

99041 MASERLO 1

ceiling light; steel, black / fabric, black
Deckenleuchte; Stahl, schwarz / Textil, schwarz
plafonnier; acier, noir / tissu, noir

H 240, Ø 400



E27 1x 40W



9 002759 990411

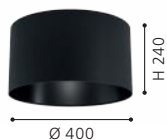

99045 MASERLO 1

table light; steel, black / fabric, black
Tischleuchte; Stahl, schwarz / Textil, schwarz
luminaire de table; acier, noir / tissu, noir

H 415, Ø 230, Base: Ø 145



E27 1x 40W



9 002759 990459



99046 MASERLO 1

floor light; steel, black / fabric, black
Stehleuchte; Stahl, schwarz / Textil, schwarz
lampadaire; acier, noir / tissu, noir

H 1515, Ø 380, Base: Ø 250



E27 1x 40W



9 002759 990466





99046



31611

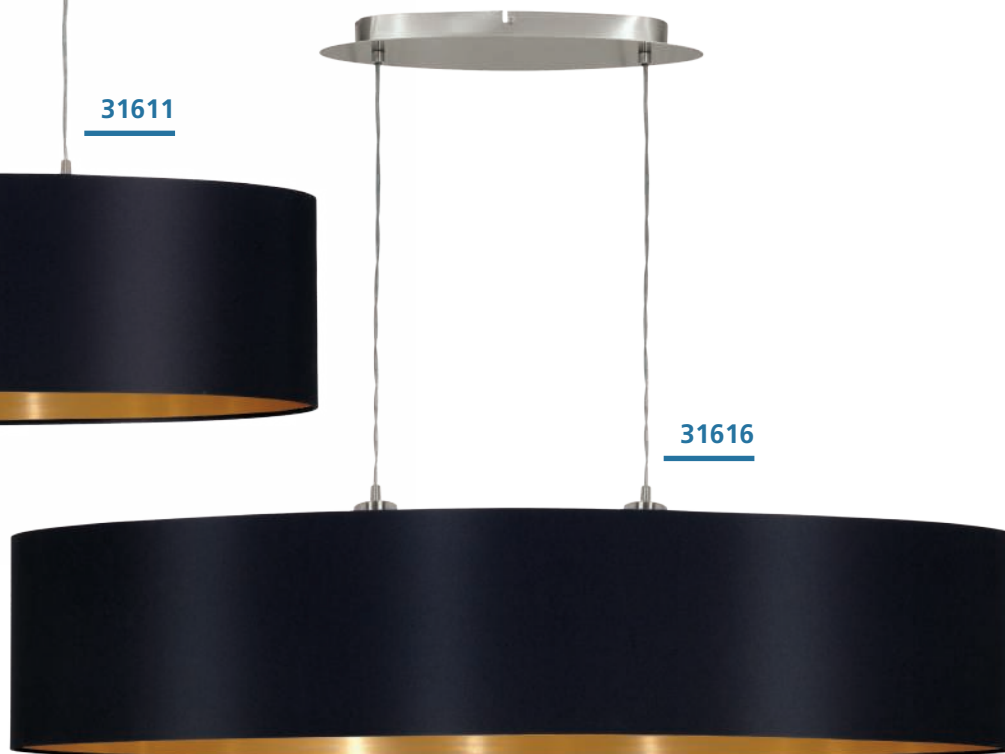

31616



31611 MASERLO

pendant light; steel, satin nickel / fabric, black, gold
 Hängeleuchte; Stahl, nickel-matt / Textil, schwarz, gold
 luminaire en suspension; acier, nickel mat / tissu, noir, or

L 780, B 220, H 1100

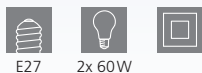

9 002759 316112

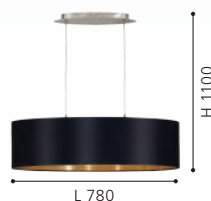

31616 MASERLO

pendant light; steel, satin nickel / fabric, black, gold
 Hängeleuchte; Stahl, nickel-matt / Textil, schwarz, gold
 luminaire en suspension; acier, nickel mat / tissu, noir, or

L 1000, B 250, H 1100



9 002759 316167

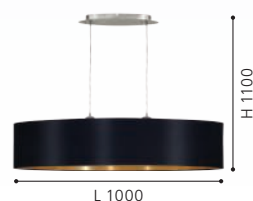



31599 MASERLO

pendant light; steel, satin nickel / fabric, black, gold
 Hängeleuchte; Stahl, nickel-matt / Textil, schwarz, gold
 luminaire en suspension; acier, nickel mat / tissu, noir, or

H 1100, Ø 380

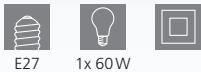

31605 MASERLO

pendant light; steel, satin nickel / fabric, black, gold
 Hängeleuchte; Stahl, nickel-matt / Textil, schwarz, gold
 luminaire en suspension; acier, nickel mat / tissu, noir, or

H 1100, Ø 530

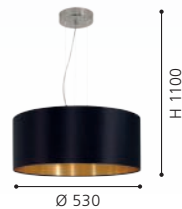



99539

LED



DESIGN
HIGHLIGHT
DETAIL



31627

99539 MASERLO 2

ceiling light; plastic, steel, white / fabric, black, gold
Deckenleuchte; Kunststoff, Stahl, weiss / Textil, schwarz, gold
plafonnier; plastique, acier, blanc / tissu, noir, or

H 90, Ø 380

LED

warm
WHITE



21,6W 2500lm



9 002759 995393

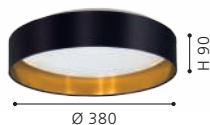

31627 MASERLO

table light; steel, satin nickel / fabric, black, gold
Tischleuchte; Stahl, nickel-matt / Textil, schwarz, gold
luminaire de table; acier, nickel mat / tissu, noir, or

H 420, Ø 230



E27 1x 60W



9 002759 316273



95169 MASERLO

floor light; steel, satin nickel / fabric, black, gold
Stehleuchte; Stahl, nickel-matt / Textil, schwarz, gold
lampadaire; acier, nickel mat / tissu, noir, or

H 1510, Ø 380, Base: Ø 250



E27 1x 60W



9 002759 951696

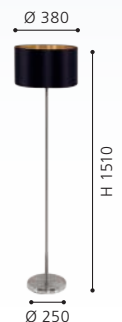



95169



31618

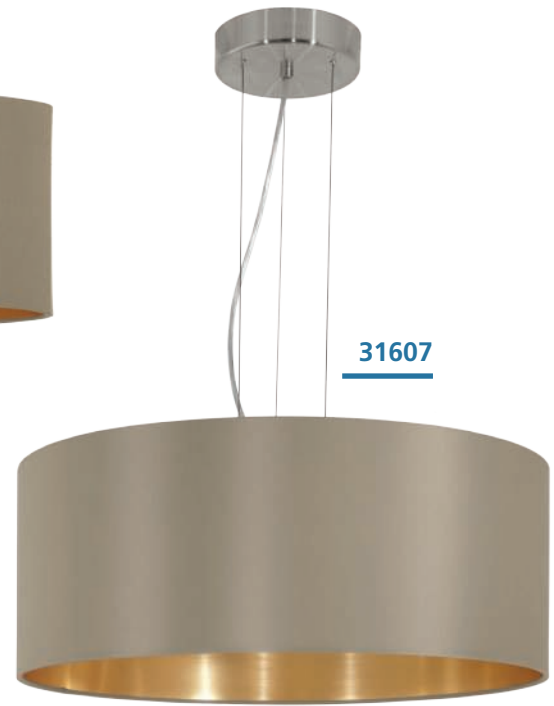

31607



31618 MASERLO

pendant light; steel, satin nickel / fabric, taupe, gold
 Hängeleuchte; Stahl, nickel-matt / Textil, taupe, gold
 luminaire en suspension; acier, nickel mat / tissu, taupe, or

L 1000, B 250, H 1100

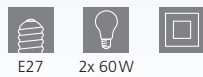

E27 2x 60W

31607 MASERLO

pendant light; steel, satin nickel / fabric, taupe, gold
 Hängeleuchte; Stahl, nickel-matt / Textil, taupe, gold
 luminaire en suspension; acier, nickel mat / tissu, taupe, or

H 1100, Ø 530



E27 3x 60W

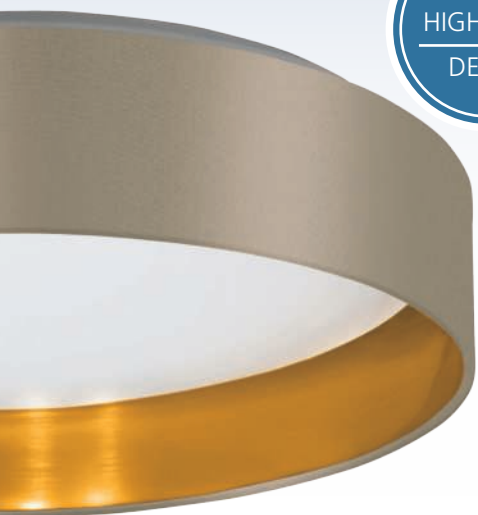

9 002759 316181

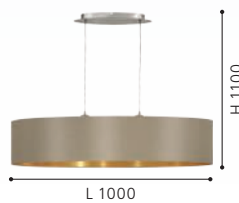

9 002759 316075

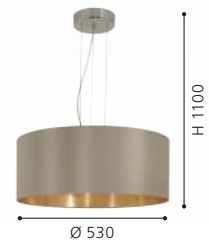



99541



31602



31613

31602 MASERLO

pendant light; steel, satin nickel / fabric, taupe, gold
Hängeleuchte; Stahl, nickel-matt / Textil, taupe, gold
luminaire en suspension; acier, nickel mat / tissu, taupe, or

H 1100, Ø 380



99541 MASERLO 2

ceiling light; plastic, steel, white / fabric, taupe, gold
Deckenleuchte; Kunststoff, Stahl, weiss / Textil, taupe, gold
plafonnier; plastique, acier, blanc / tissu, taupe, or

H 90, Ø 380

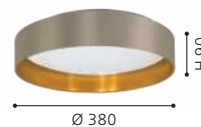

31613 MASERLO

pendant light; steel, satin nickel / fabric, taupe, gold
Hängeleuchte; Stahl, nickel-matt / Textil, taupe, gold
luminaire en suspension; acier, nickel mat / tissu, taupe, or

L 780, B 220, H 1100

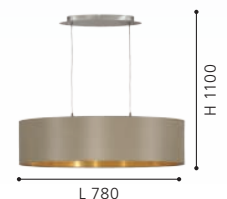
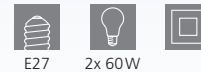

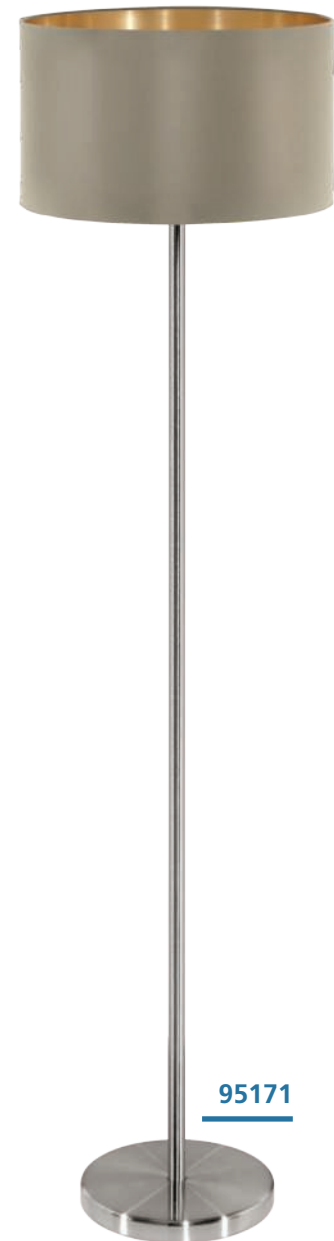

95055 MASERLO

wall light; steel, satin nickel / fabric, taupe, gold
 Wandleuchte; Stahl, nickel-matt / Textil, taupe, gold
 applique; acier, nickel mat / tissu, taupe, or

H 260, Ø 230, A 595

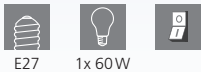

E27 1x 60W



9 002759 950552

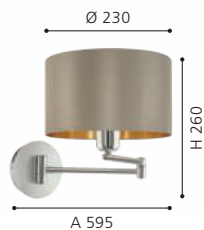

31629 MASERLO

table light; steel, satin nickel / fabric, taupe, gold
 Tischleuchte; Stahl, nickel-matt / Textil, taupe, gold
 luminaire de table; acier, nickel mat / tissu, taupe, or

H 420, Ø 230

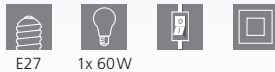

E27 1x 60W



9 002759 316297



95171 MASERLO

floor light; steel, satin nickel / fabric, taupe, gold
 Stehleuchte; Stahl, nickel-matt / Textil, taupe, gold
 lampadaire; acier, nickel mat / tissu, taupe, or

H 1510, Ø 380, Base: Ø 250



E27 1x 60W



9 002759 951719





31614 MASERLO

pendant light; steel, satin nickel / fabric, cappuccino, gold
 Hängeleuchte; Stahl, nickel-matt / Textil, cappuccino, gold
 luminaire en suspension; acier, nickel mat / tissu, cappucino, or

L 780, B 220, H 1100

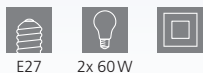

E27 2x 60W



9 002759 316143

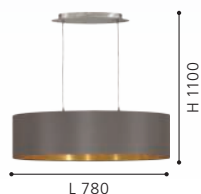

31619 MASERLO

pendant light; steel, satin nickel / fabric, cappuccino, gold
 Hängeleuchte; Stahl, nickel-matt / Textil, cappuccino, gold
 luminaire en suspension; acier, nickel mat / tissu, cappucino, or

L 1000, B 250, H 1100

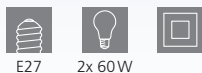

E27 2x 60W



9 002759 316198



31603 MASERLO

pendant light; steel, satin nickel / fabric, cappuccino, gold
 Hängeleuchte; Stahl, nickel-matt / Textil, cappuccino, gold
 luminaire en suspension; acier, nickel mat / tissu, cappucino, or

H 1100, Ø 380

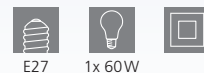

E27 1x 60W



9 002759 316037





99542

LED

DESIGN
HIGHLIGHT
DETAIL

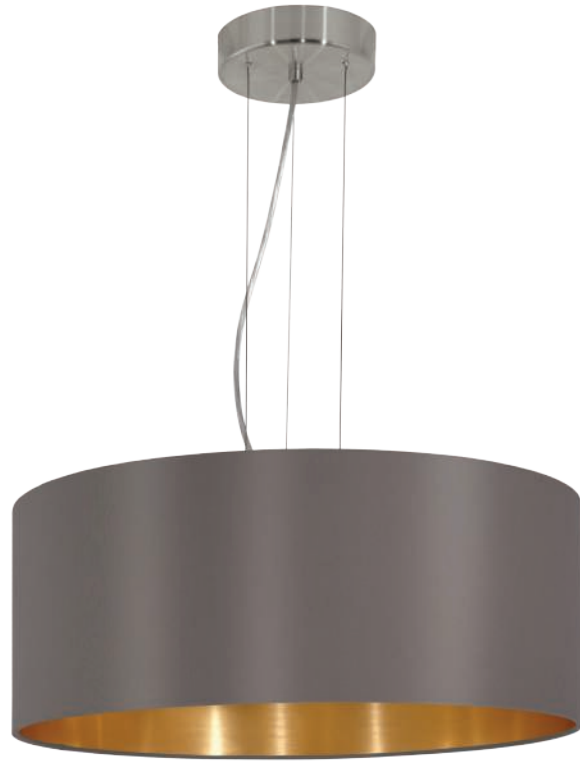

31608

99542 MASERLO 2

ceiling light; plastic, steel, white / fabric, cappuccino, gold
Deckenleuchte; Kunststoff, Stahl, weiss / Textil, cappuccino, gold
plafonnier; plastique, acier, blanc / tissu, cappuccino, or

H 90, Ø 380

LED

warm
WHITE



21,6W 2500lm



9 002759 995423

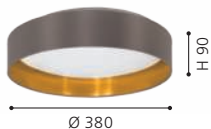

31608 MASERLO

pendant light; steel, satin nickel / fabric, cappuccino, gold
Hängeleuchte; Stahl, nickel-matt / Textil, cappuccino, gold
luminaire en suspension; acier, nickel mat / tissu, cappuccino, or

H 1100, Ø 530



E27



3x 60W



9 002759 316082



31631 MASERLO

table light; steel, satin nickel / fabric, cappuccino, gold
Tischleuchte; Stahl, nickel-matt / Textil, cappuccino, gold
luminaire de table; acier, nickel mat / tissu, cappuccino, or

H 420, Ø 230



E27



1x 60W



9 002759 316310

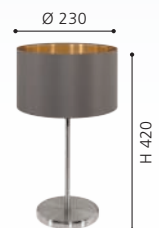



31631

95172 MASERLO

floor light; steel, satin nickel / fabric, cappuccino, gold
 Stehleuchte; Stahl, nickel-matt / Textil, cappuccino, gold
 lampadaire; acier, nickel mat / tissu, cappucino, or

H 1510, Ø 380, Base: Ø 250



E27



1x 60W



Ø 380



H 1510

Ø 250



9 002759 951726



95172



97684

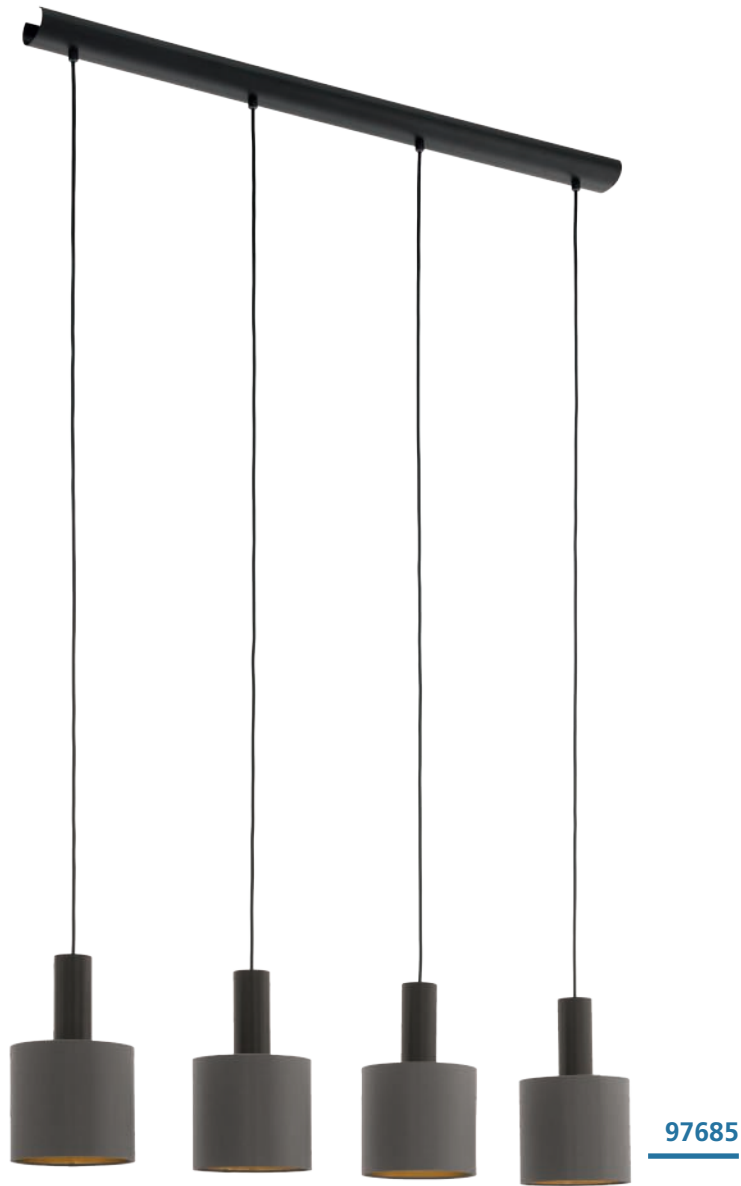

97685

97684 CONCESSA 1

pendant light; steel, dark brown / fabric, cappuccino, gold
 Hängeleuchte; Stahl, dunkelbraun / Textil, cappuccino, gold
 luminaire en suspension; acier, marron foncé / tissu, cappuccino, or

H 1500, Ø 420



9 002759 976842



97685 CONCESSA 1

pendant light; steel, dark brown / fabric, cappuccino, gold
 Hängeleuchte; Stahl, dunkelbraun / Textil, cappuccino, gold
 luminaire en suspension; acier, marron foncé / tissu, cappuccino, or

L 940, B 160, H 1500



9 002759 976859

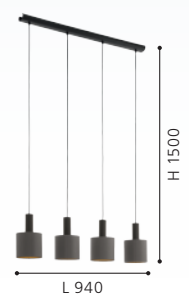

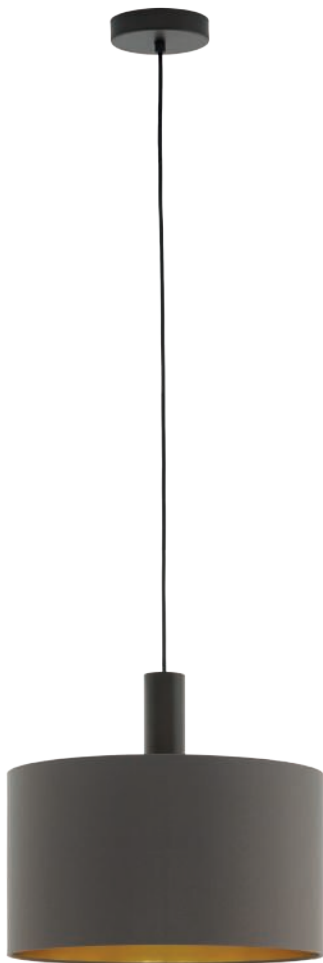

97682



97683

DESIGN
HIGHLIGHT
DETAIL

97682 CONCESSA 1

pendant light; steel, dark brown / fabric, cappuccino, gold
Hängeleuchte; Stahl, dunkelbraun / Textil, cappuccino, gold
luminaire en suspension; acier, marron foncé / tissu, cappuccino, or

H 1500, Ø 380

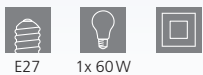

9 002759 976828



97683 CONCESSA 1

pendant light; steel, dark brown / fabric, cappuccino, gold
Hängeleuchte; Stahl, dunkelbraun / Textil, cappuccino, gold
luminaire en suspension; acier, marron foncé / tissu, cappuccino, or

H 1500, Ø 530

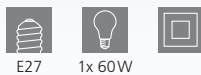

9 002759 976835



DESIGN
HIGHLIGHT
DETAIL



99445



99446



99445 ALBARIZA

pendant light; steel, wood, black, brown / fabric, cappuccino, gold

Hängeleuchte; Stahl, Holz, schwarz, braun / Textil, cappuccino, gold

luminaire en suspension; acier, bois, noir, marron / tissu, cappuccino, or

H 1100, Ø 160



E27

1x 40W



9 002759 994457



99446 ALBARIZA

pendant light; steel, wood, black, brown / fabric, cappuccino, gold

Hängeleuchte; Stahl, Holz, schwarz, braun / Textil, cappuccino, gold

luminaire en suspension; acier, bois, noir, marron / tissu, cappuccino, or

L 895, B 160, H 1100



E27

3x 40W



9 002759 994464



99447 ALBARIZA

pendant light; steel, wood, black, brown / fabric, cappuccino, gold

Hängeleuchte; Stahl, Holz, schwarz, braun / Textil, cappuccino, gold

luminaire en suspension; acier, bois, noir, marron / tissu, cappuccino, or

H 1500, Ø 700



E27

5x 40W



9 002759 994471





99447





99487 ALMEIDA 2

pendant light; steel, brushed brass / fabric, cappuccino, brass
 Hängeleuchte; Stahl, messing-gebürstet / Textil, cappuccino, messing
 luminaire en suspension; acier, laiton brossé / tissu, cappuccino, laiton

L 1200, B 155, H 1100

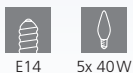

E14 5x 40W



9 002759 994877

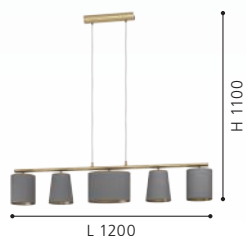

99486 ALMEIDA 2

ceiling light; steel, brushed brass / fabric, cappuccino, brass
 Deckenleuchte; Stahl, messing-gebürstet / Textil, cappuccino, messing
 plafonnier; acier, laiton brossé / tissu, cappuccino, laiton

L 810, B 155, H 280

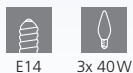

E14 3x 40W



9 002759 994860

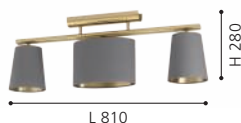

99612 ALMEIDA 2

floor light; steel, brushed brass / fabric, cappuccino, brass
 Stehleuchte; Stahl, messing-gebürstet / Textil, cappuccino, messing
 lampadaire; acier, laiton brossé / tissu, cappuccino, laiton

H 1670, Ø 320, Base: Ø 300



E27 3x 40W



9 002759 996123





99612

99611 ALMEIDA 2

table light; steel, brushed brass / fabric, cappuccino, brass
 Tischleuchte; Stahl, messing-gebürstet / Textil, cappuccino, messing
 luminaire de table; acier, laiton brossé / tissu, cappuccino, laiton

H 605, Ø 260, Base: Ø 200



E27



2x 40W



9 002759 996116



99611

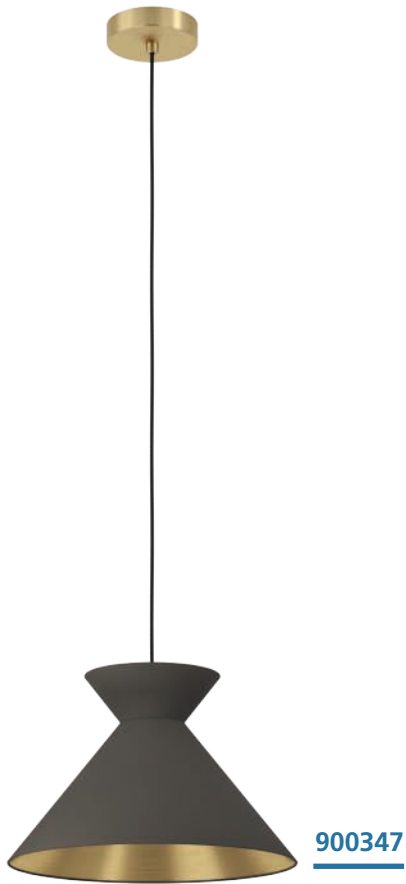

900347



900348



DESIGN
HIGHLIGHT
DETAIL

900347 NASTASIA

pendant light; steel, black / fabric, cappuccino, brass
Hängeleuchte; Stahl, schwarz / Textil, cappuccino, messing
luminaire en suspension; acier, noir / tissu, cappuccino, laiton

H 1100, Ø 380



E27 1x 40W



9 008606 238859



900348 NASTASIA

pendant light; steel, black / fabric, cappuccino, brass
Hängeleuchte; Stahl, schwarz / Textil, cappuccino, messing
luminaire en suspension; acier, noir / tissu, cappuccino, laiton

L 1000, B 240, H 1100



E27 3x 40W



9 008606 238866

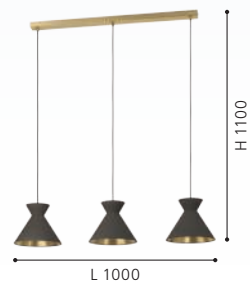



900376

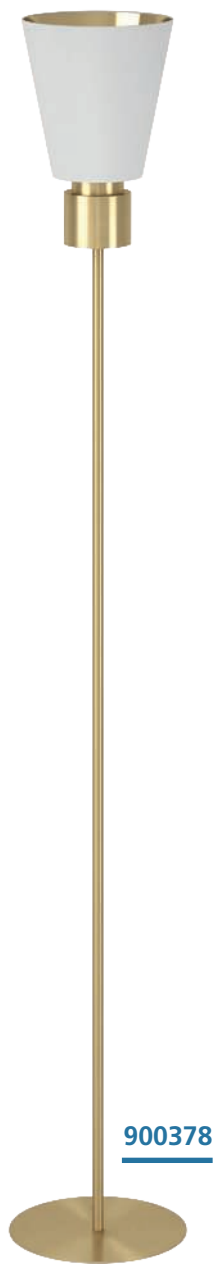

900378



900377

900376 AGLIENTINA

pendant light; steel, brushed brass / fabric, white, brass
Hängeleuchte; Stahl, messing-gebürstet / Textil, weiss, messing
luminaire en suspension; acier, laiton brossé / tissu, blanc, laiton

H 1100, Ø 200

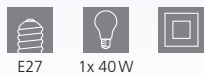

E27 1x 40W



9 008606 243587



900378 AGLIENTINA

floor light; steel, brushed brass / fabric, white, brass
Stehleuchte; Stahl, messing-gebürstet / Textil, weiss, messing
lampadaire; acier, laiton brossé / tissu, blanc, laiton

H 1700, Ø 200, Base: Ø 250



E27 1x 40W



9 008606 243600



900377 AGLIENTINA

pendant light; steel, brushed brass / fabric, white, brass
Hängeleuchte; Stahl, messing-gebürstet / Textil, weiss, messing
luminaire en suspension; acier, laiton brossé / tissu, blanc, laiton

L 900, B 200, H 1100



E27 3x 40W



9 008606 243594





98587



98588



98587 ALMEIDA 1

pendant light; steel, black / fabric, grey, white
 Hängeleuchte; Stahl, schwarz / Textil, grau, weiss
 luminaire en suspension; acier, noir / tissu, gris, blanc

L 860, B 255, H 1100



E14 3x 25W

98588 ALMEIDA 1

pendant light; steel, black / fabric, black, grey, white
 Hängeleuchte; Stahl, schwarz / Textil, schwarz, grau, weiss
 luminaire en suspension; acier, noir / tissu, noir, gris, blanc

L 1200, B 255, H 1100

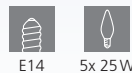

E14 5x 25W





95192



95194



94995

95192 ALMEIDA

ceiling light; steel, black / fabric, anthracite, white, brown
Deckenleuchte; Stahl, schwarz / Textil, anthrazit, weiss, braun
plafonnier; acier, noir / tissu, anthracite, blanc, marron

H 350, Ø 590

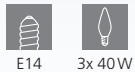

E14 3x 40W



9 002759 951924

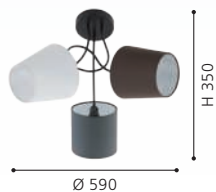

95194 ALMEIDA

table light; steel, black / fabric, white, anthracite
Tischleuchte; Stahl, schwarz / Textil, weiss, anthrazit
luminaire de table; acier, noir / tissu, blanc, anthracite

L 380, B 185, H 475, Base: Ø 155

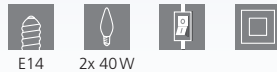

E14 2x 40W



9 002759 951948



94995 MARONDA

floor light; steel, black / fabric, anthracite, white, brown
Stehleuchte; Stahl, schwarz / Textil, anthrazit, weiss, braun
lampadaire; acier, noir / tissu, anthracite, blanc, marron

L 275, B 35, H 1520, Base: Ø 230

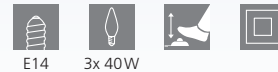

E14 3x 40W



9 002759 949952

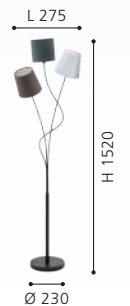

LIGHTING FAMILIES

WOOD LUMINAIRES
HOLZLEUCHTEN
LUMINAIRES À BOIS

SIMPLE CLASSINESS

The wood luminaires with their unusual designs are perfectly trendy and bring cosiness to every home. Our range of wood luminaires offers a great selection of various shapes, sizes and colours. It contains anything from suspended to table luminaires.

SCHLICHTE ELEGANZ

Die Holzleuchten mit ihrem außergewöhnlichen Design sind voll im Trend und sorgen für Gemütlichkeit in jedem Zuhause. Unser Sortiment an Holzleuchten bietet eine große Auswahl an verschiedenen Formen, Größen sowie Farben und reicht von der Hänge- bis hin zur Tischleuchte.



ÉLÉGANCE SIMPLE

Les luminaires en bois avec leur design extraordinaire sont très tendance et assurent un confort dans chaque maison. Notre gamme de luminaires en bois offre un grand choix de formes, de tailles et de couleurs différentes et s'étend des luminaires en suspension jusqu'aux luminaires de table.



OVERVIEW

LIGHTING FAMILIES / WOOD



VELASCO
p. 196-197



BAJAZZARA
p. 198-199



RUSTICARIA
p. 199



STELLATO 1
p. 200-201



STELLATO 2
p. 201-202



STELLATO 3
p. 203



TINDORI
p. 204-205



COSSANO
p. 205-207



COSSANO 2
p. 208



SENDERO
p. 210-211



This product is available in different colors and shapes./ Dieser Artikel ist in unterschiedlichen Farben und Formen verfügbar.
Cet article est disponible en différentes couleurs et formes.

WOOD MATERIALS

LAMELLA SHADES



wood, white
Holz, weiß
bois, blanc



wood, brown
Holz, braun
bois, marron



wood, maple
Holz, ahorn
bois, érable



wood, maple
Holz, ahorn
bois, érable



wood, brown
Holz, braun
bois, marron



wood, black
Holz, schwarz
bois, noir



wood, grey
Holz, grau
bois, gris



wood, nut
Holz, nuss
bois, noix



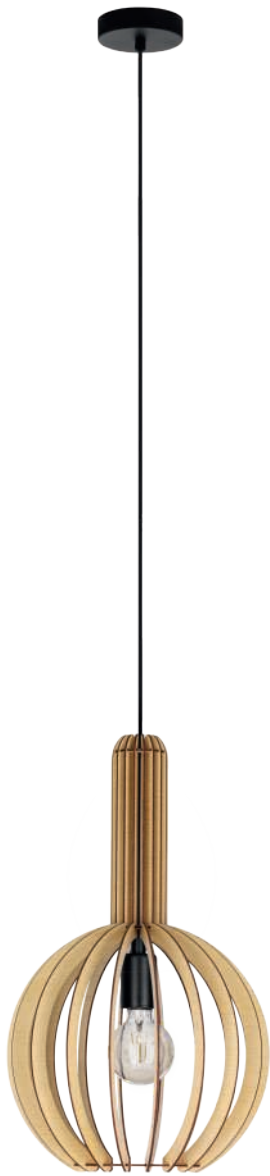

900151



900152

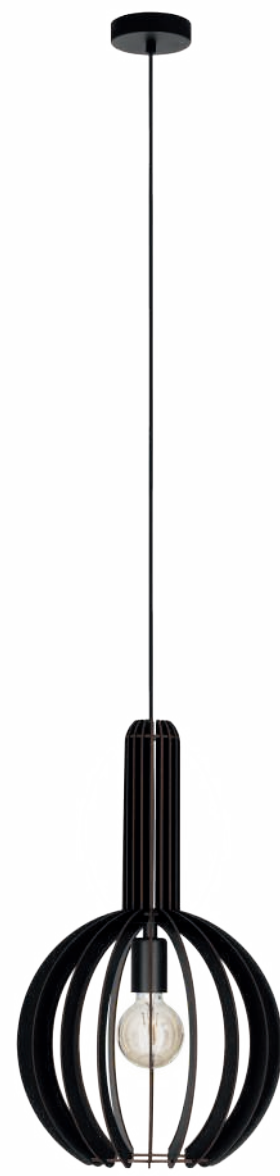

900153

900151 VELASCO

pendant light; steel, black / wood, maple
Hängeleuchte; Stahl, schwarz / Holz, ahorn
luminaire en suspension; acier, noir / bois, érable

H 1100, Ø 310



E27 1x 40W



9 008606 224043

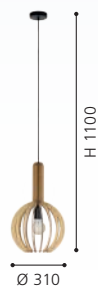

900152 VELASCO

pendant light; steel, black / wood, maple
Hängeleuchte; Stahl, schwarz / Holz, ahorn
luminaire en suspension; acier, noir / bois, érable

H 1100, Ø 380



E27 1x 40W



9 008606 224050



900153 VELASCO

pendant light; steel, black / wood, black
Hängeleuchte; Stahl, schwarz / Holz, schwarz
luminaire en suspension; acier, noir / bois, noir

H 1100, Ø 310

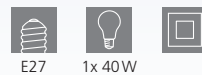

E27 1x 40W



9 008606 224067





900154



900154 VELASCO

pendant light; steel, black / wood, black
Hängeleuchte; Stahl, schwarz / Holz, schwarz
luminaire en suspension; acier, noir / bois, noir

H 1100, Ø 380



E27



1x 40W



9 008606 224074

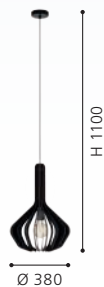



900503



900502



900504

900503 BAJAZZARA

pendant light; steel, black / wood, grey
Hängeleuchte; Stahl, schwarz / Holz, grau
luminaire en suspension; acier, noir / bois, gris

L 890, B 190, H 1100



E27



3x 40W



9 008606 244331



900502 BAJAZZARA

pendant light; steel, black / wood, grey
Hängeleuchte; Stahl, schwarz / Holz, grau
luminaire en suspension; acier, noir / bois, gris

H 1100, Ø 260



E27



1x 40W



9 008606 244324



900504 BAJAZZARA

pendant light; steel, black / wood, black
Hängeleuchte; Stahl, schwarz / Holz, schwarz
luminaire en suspension; acier, noir / bois, noir

H 1100, Ø 260



E27



1x 40W



9 008606 244348





900505



900385



900386



900505 BAJAZZARA

pendant light; steel, black / wood, black
Hängeleuchte; Stahl, schwarz / Holz, schwarz
luminaire en suspension; acier, noir / bois, noir

L 890, B 190, H 1100



E27 3x 40W



9 008606 244355



900385 RUSTICARIA

ceiling light; steel, black / wood, glass, brown, white
Deckenleuchte; Stahl, schwarz / Holz, Glas, braun, weiss
plafonnier; acier, noir / bois, verre, marron, blanc

H 275, Ø 450



E27 1x 40W



9 008606 240036



900386 RUSTICARIA

pendant light; steel, black / wood, glass, brown, white
Hängeleuchte; Stahl, schwarz / Holz, Glas, braun, weiss
luminaire en suspension; acier, noir / bois, verre, marron, blanc

H 1100, Ø 450



E27 1x 40W



9 008606 240043





95599



95598



95602

95599 STELLATO 1

pendant light; steel, satin nickel / wood, glass, maple, white
 Hängeleuchte; Stahl, nickel-matt / Holz, Glas, ahorn, weiss
 luminaire en suspension; acier, nickel mat / bois, verre, érable, blanc

H 1500, Ø 500

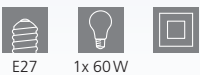

95598 STELLATO 1

pendant light; steel, satin nickel / wood, glass, maple, white
 Hängeleuchte; Stahl, nickel-matt / Holz, Glas, ahorn, weiss
 luminaire en suspension; acier, nickel mat / bois, verre, érable, blanc

H 1300, Ø 400



95602 STELLATO 1

wall light; steel, white / wood, glass, maple, white
 Wandleuchte; Stahl, weiss / Holz, Glas, ahorn, weiss
 applique; acier, blanc / bois, verre, érable, blanc

L 285, H 250, A 140

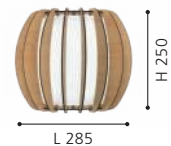



95597



95607



STELLATO 1
STELLATO 2



95606

95597 STELLATO 1

ceiling light; steel, satin nickel / wood, glass, maple, white
Deckenleuchte; Stahl, nickel-matt / Holz, Glas, ahorn, weiss
plafonnier; acier, nickel mat / bois, verre, érable, blanc

H 275, Ø 400



E27 1x 60W



9 002759 955977

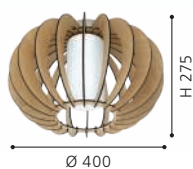

95606 STELLATO 2

pendant light; steel, white / wood, glass, white
Hängeleuchte; Stahl, weiss / Holz, Glas, weiss
luminaire en suspension; acier, blanc / bois, verre, blanc

H 1300, Ø 400

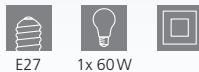

E27 1x 60W



9 002759 956066



95607 STELLATO 2

pendant light; steel, white / wood, glass, white
Hängeleuchte; Stahl, weiss / Holz, Glas, weiss
luminaire en suspension; acier, blanc / bois, verre, blanc

H 1500, Ø 500



E27 1x 60W



9 002759 956073



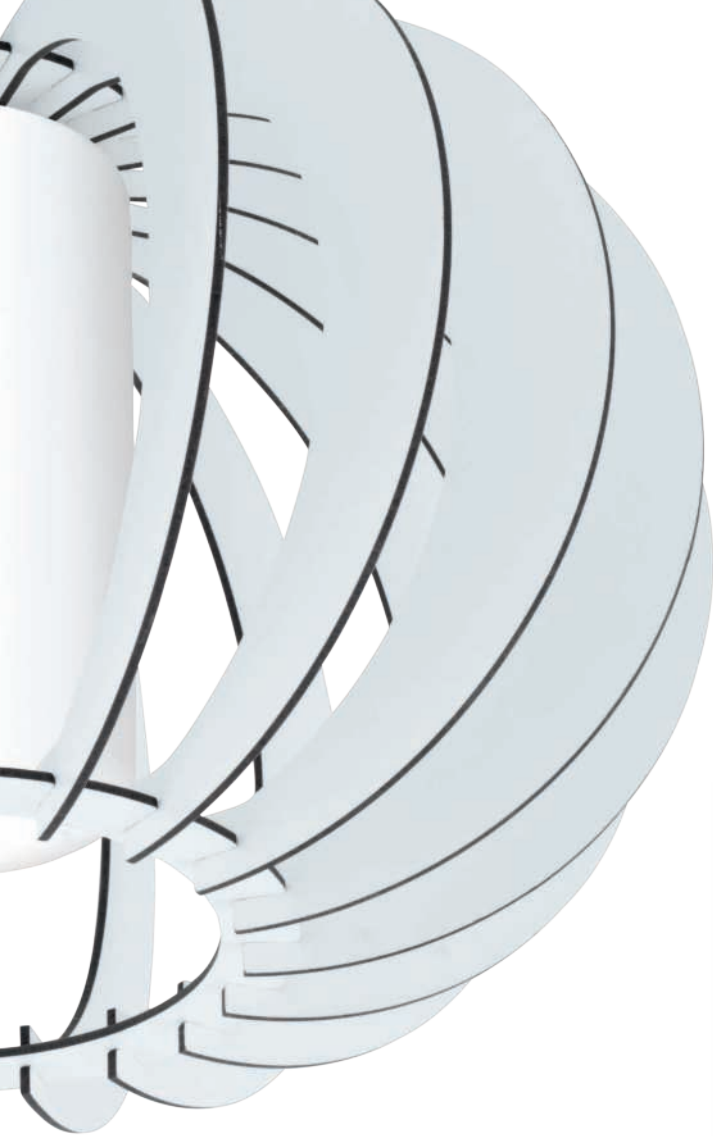

DESIGN
HIGHLIGHT
DETAIL

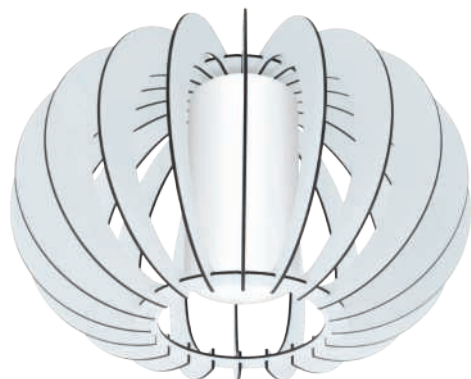

95605



95609



STELLATO 2
STELLATO 3

95609 STELLATO 2

wall light; steel, white / wood, glass, white
Wandleuchte; Stahl, weiss / Holz, Glas, weiss
applique; acier, blanc / bois, verre, blanc

L 285, H 250, A 140



95605 STELLATO 2

ceiling light; steel, white / wood, glass, white
Deckenleuchte; Stahl, weiss / Holz, Glas, weiss
plafonnier; acier, blanc / bois, verre, blanc

H 275, Ø 400



9 002759 956097

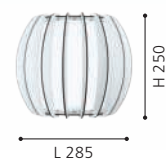

9 002759 956059

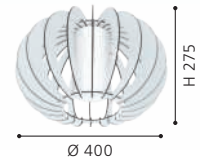



95591



95589



95594

95591 STELLATO 3

pendant light; steel, satin nickel / wood, glass, brown, white
 Hängeleuchte; Stahl, nickel-matt / Holz, Glas, braun, weiss
 luminaire en suspension; acier, nickel mat / bois, verre, marron, blanc

H 1300, Ø 400



9 002759 955915



95589 STELLATO 3

ceiling light; steel, satin nickel / wood, glass, brown, white
 Deckenleuchte; Stahl, nickel-matt / Holz, Glas, braun, weiss
 plafonnier; acier, nickel mat / bois, verre, marron, blanc

H 275, Ø 400



9 002759 955892

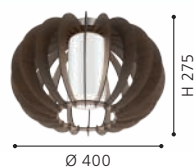

95594 STELLATO 3

wall light; steel, white / wood, glass, brown, white
 Wandleuchte; Stahl, weiss / Holz, Glas, braun, weiss
 applique; acier, blanc / bois, verre, marron, blanc

L 285, H 250, A 140



9 002759 955946

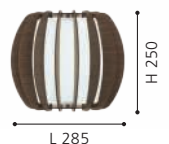



96211 | 96214



96257



96211



96258

96257 TINDORI

pendant light; steel, satin nickel / wood, white
Hängeleuchte; Stahl, nickel-matt / Holz, weiss
luminaire en suspension; acier, nickel mat / bois, blanc

H 1300, Ø 380

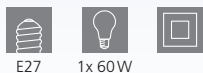

9 002759 962579



96211 TINDORI

pendant light; steel, satin nickel / wood, glass, white
Hängeleuchte; Stahl, nickel-matt / Holz, Glas, weiss
luminaire en suspension; acier, nickel mat / bois, verre, blanc

H 1500, Ø 500



9 002759 962111



96258 TINDORI

pendant light; steel, satin nickel / wood, maple
Hängeleuchte; Stahl, nickel-matt / Holz, ahorn
luminaire en suspension; acier, nickel mat / bois, érable

H 1300, Ø 380



9 002759 962586





96214



94438



94442

96214 TINDORI

pendant light; steel, satin nickel / wood, glass, maple, white
 Hängeleuchte; Stahl, nickel-matt / Holz, Glas, ahorn, weiss
 luminaire en suspension; acier, nickel mat / bois, verre, érable, blanc

H 1500, Ø 500



E27 1x 60W



9 002759 962142

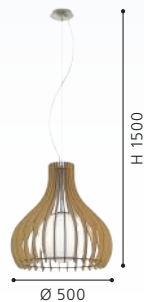

94438 COSSANO

pendant light; steel, white / wood, white
 Hängeleuchte; Stahl, weiss / Holz, weiss
 luminaire en suspension; acier, blanc / bois, blanc

H 1300, Ø 300

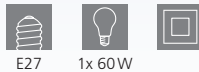

E27 1x 60W



9 002759 944384



94442 COSSANO

pendant light; steel, white / wood, white
 Hängeleuchte; Stahl, weiss / Holz, weiss
 luminaire en suspension; acier, blanc / bois, blanc

H 1500, Ø 450

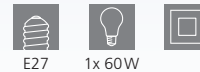

E27 1x 60W



9 002759 944421





94635

94636

94635 COSSANO

pendant light; steel, satin nickel / wood, brown
 Hängeleuchte; Stahl, nickel-matt / Holz, braun
 luminaire en suspension; acier, nickel mat / bois, marron

H 1300, Ø 300

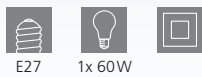

94636 COSSANO

pendant light; steel, satin nickel / wood, brown
 Hängeleuchte; Stahl, nickel-matt / Holz, braun
 luminaire en suspension; acier, nickel mat / bois, marron

H 1500, Ø 500

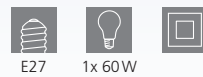

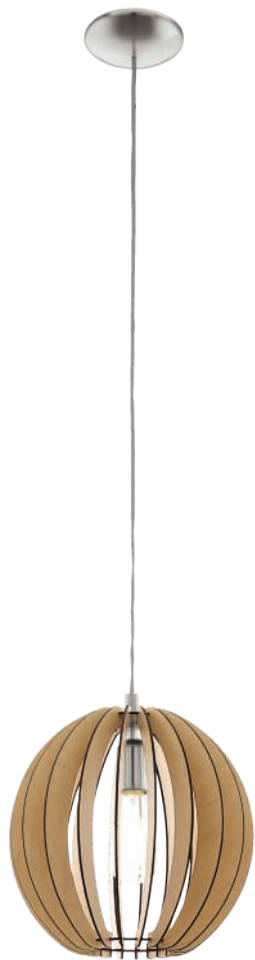

94764



94765

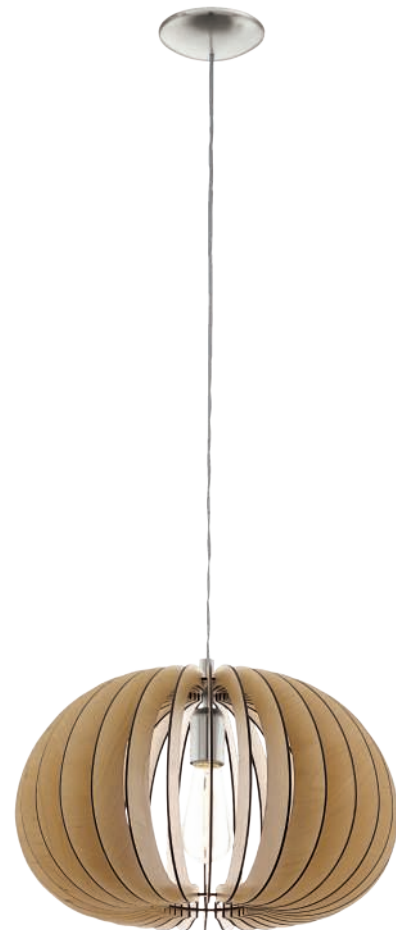

94767

94764 COSSANO

pendant light; steel, satin nickel / wood, maple
Hängeleuchte; Stahl, nickel-matt / Holz, ahorn
luminaire en suspension; acier, nickel mat / bois, érable

H 1300, Ø 300

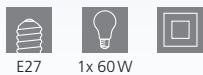

E27 1x 60W



9 002759 947644



94765 COSSANO

pendant light; steel, satin nickel / wood, maple
Hängeleuchte; Stahl, nickel-matt / Holz, ahorn
luminaire en suspension; acier, nickel mat / bois, érable

H 1500, Ø 500

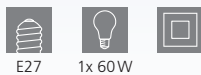

E27 1x 60W



9 002759 947651



94767 COSSANO

pendant light; steel, satin nickel / wood, maple
Hängeleuchte; Stahl, nickel-matt / Holz, ahorn
luminaire en suspension; acier, nickel mat / bois, érable

H 1500, Ø 450

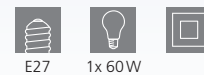

E27 1x 60W



9 002759 947675



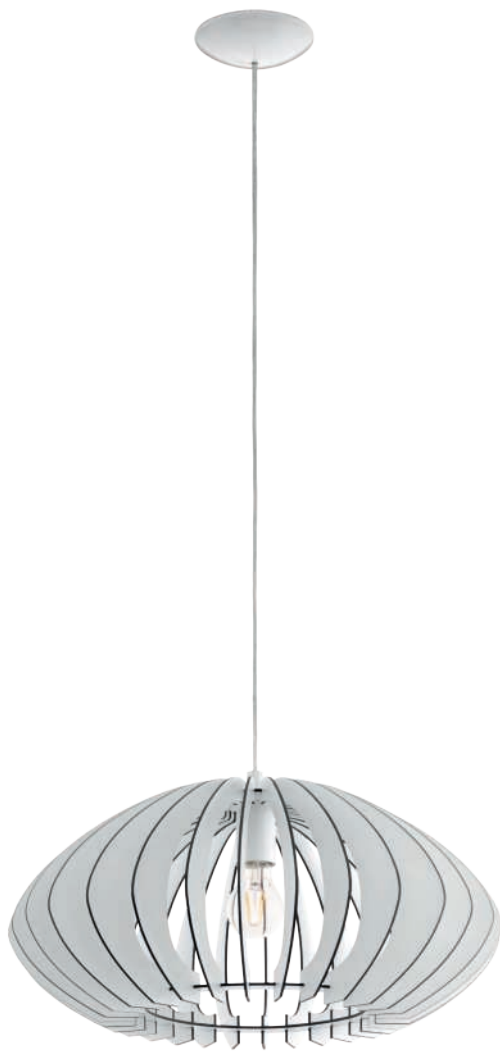

95254

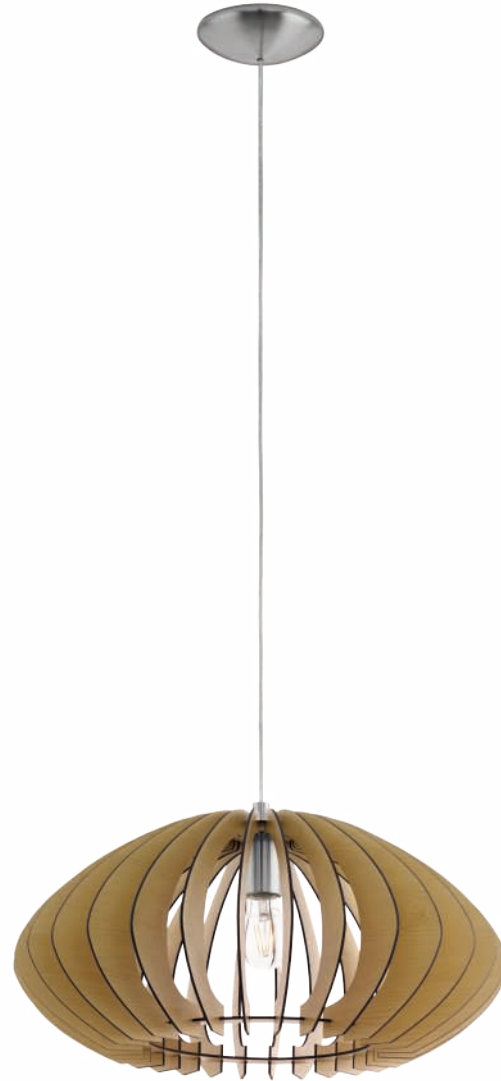

95257

95254 COSSANO 2

pendant light; steel, white / wood, white
 Hängeleuchte; Stahl, weiss / Holz, weiss
 luminaire en suspension; acier, blanc / bois, blanc

H 1500, Ø 500

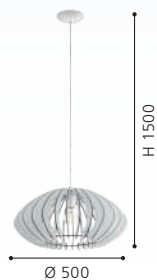

95257 COSSANO 2

pendant light; steel, satin nickel / wood, maple
 Hängeleuchte; Stahl, nickel-matt / Holz, ahorn
 luminaire en suspension; acier, nickel mat / bois, érable

H 1500, Ø 500

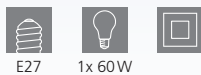

95261 COSSANO 2

pendant light; steel, satin nickel / wood, dark brown
 Hängeleuchte; Stahl, nickel-matt / Holz, dunkelbraun
 luminaire en suspension; acier, nickel mat / bois, marron foncé

H 1500, Ø 500





95261





96194



96195



96193

96194 SENDERO

pendant light; steel, satin nickel / wood, maple
Hängeleuchte; Stahl, nickel-matt / Holz, ahorn
luminaire en suspension; acier, nickel mat / bois, érable

L 775, B 250, H 1300



E27



2x 60W



9 002759 961947



96193 SENDERO

pendant light; steel, satin nickel / wood, maple
Hängeleuchte; Stahl, nickel-matt / Holz, ahorn
luminaire en suspension; acier, nickel mat / bois, érable

H 1300, Ø 450



E27



1x 60W



9 002759 961930



96195 SENDERO

wall light; steel, white / wood, maple
Wandleuchte; Stahl, weiss / Holz, ahorn
applique; acier, blanc / bois, érable

L 240, H 220, A 120



E27



1x 60W



9 002759 961954





96199



96201

96199 SENDERO

pendant light; steel, satin nickel / wood, brown
 Hängeleuchte; Stahl, nickel-matt / Holz, braun
 luminaire en suspension; acier, nickel mat / bois, marron

H 1300, Ø 450



9 002759 961992



96201 SENDERO

pendant light; steel, satin nickel / wood, brown
 Hängeleuchte; Stahl, nickel-matt / Holz, braun
 luminaire en suspension; acier, nickel mat / bois, marron

L 775, B 250, H 1300

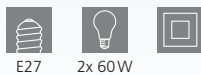

9 002759 962012



LIGHTING FAMILIES

STANDARD LUMINAIRES
STANDARD LEUCHTEN
LUMINAIRES STANDARD

FAMILY MEETING

This range combines ceiling, wall, suspended, floor and table luminaires. Give your rooms a consistent and stylish all-round illumination.

FAMILIENTREFFEN

Dieses Sortiment vereint sowohl Decken-, Wand- und Hängeleuchten als auch Tisch- und Stehleuchten. Verleihen Sie Ihren Räumlichkeiten eine einheitliche und stilvolle Rundumbeleuchtung.







RENCONTRE FAMILIALE

Cette gamme réunit aussi bien des plafonniers, des éclairages muraux, des éclairages suspendus que des lampes de table et des lampadaires. Donnez à vos pièces un éclairage d'ensemble unifié et riche en style.



OVERVIEW

LIGHTING FAMILIES / STANDARD

 TURALDO p. 216	 LIBERTAD p. 218, 220	 LIBERTAD 1 p. 219	 CAMACHO p. 222-223	 BOYAL p. 224-227	 PANAGRIA p. 228-229	 CANTERRAS p. 230-231	 ABREOSA p. 232
 CASIBARE p. 234-235	 CREMELLA p. 236-237	 ROMAZZINA p. 238-241	 VENEZUELA p. 242-243	 ESCANDIDOS p. 244-245	 LURONE p. 246-247	 NARICES p. 248-249	 ERSEKA p. 250-251
 MANZANARES p. 252-253	 RONDO p. 254-255	 RONDO 3 p. 256	 OPTICA p. 258-260	 GOROSIBA 1 p. 262	 GOROSIBA p. 262-263	 PINTO TEXTIL 1 p. 264	 PINTO TEXTIL p. 266-267
 PINTO NERO p. 268	 PINTO GOLD p. 270-271	 PINTO p. 272-273	 TROY 3 p. 274-275	 RIVATO p. 276-277	 AMADORA p. 278	 BAYMAN p. 279	 VINOVO p. 280
 MURCIA p. 280-281	 SAVOY p. 282-283	 MARBELLA p. 284-285	 ERVIDEL p. 286-287	 CLAVELLINA p. 288-289	 ISIDRO p. 290-291	 CARANACOA p. 292-293	 BANDERILLAS p. 294-295
 ALAMEDILLA p. 294	 CODRIALES p. 296-297	 SIBERIA p. 298-299	 LEJIAS p. 300-301	 LASANA 1 p. 302, 307	 LASANA 2 p. 302-303	 LASANA 3 p. 304-305	 LASANA p. 306



This product is available in different colors and shapes./ Dieser Artikel ist in unterschiedlichen Farben und Formen verfügbar.
Cet article est disponible en différentes couleurs et formes.



TARANDELL
p. 307



RONCADE 1
p. 308



SELVINA 1
p. 308



RONCADE
p. 309, 313



SELVINA
p. 309-310, 312



VALMORA
p. 310-311



NEVADO
p. 311



PALOZZA 1
p. 312



PALOZZA
p. 314-315





DESIGN
HIGHLIGHT
DETAIL



99077



99079

99077 TURALDO

ceiling light; wood, brown
Deckenleuchte; Holz, braun
plafonnier; bois, marron

H 80, Ø 70



E27 1x 28W



9 002759 990770

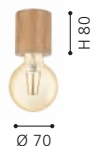

99079 TURALDO

table light; wood, brown
Tischleuchte; Holz, braun
luminaire de table; bois, marron

H 100, Ø 85



E27 1x 28W



9 002759 990794



99078 TURALDO

pendant light; wood, steel, brown, black
Hängeleuchte; Holz, Stahl, braun, schwarz
luminaire en suspension; bois, acier, marron, noir

H 1100, Ø 105



E27 1x 28W



9 002759 990787

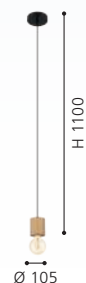



99078

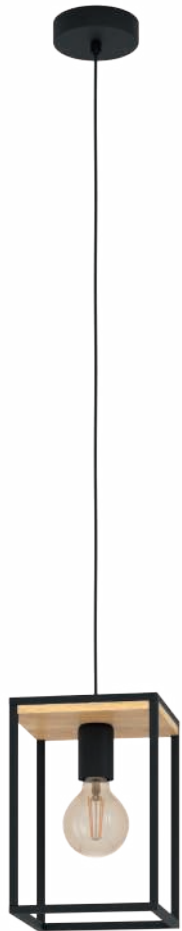

99795



99856



99855



99795 LIBERTAD

pendant light; steel, wood, black, brown
 Hängeleuchte; Stahl, Holz, schwarz, braun
 luminaire en suspension; acier, bois, noir, marron

L 180, B 180, H 1100



E27

1x 40W



9 002759 997953



99855 LIBERTAD

pendant light; steel, wood, black, brown
 Hängeleuchte; Stahl, Holz, schwarz, braun
 luminaire en suspension; acier, bois, noir, marron

L 880, B 180, H 1100



E27

3x 40W



9 002759 998554



99856 LIBERTAD

ceiling light; steel, wood, black, brown
 Deckenleuchte; Stahl, Holz, schwarz, braun
 plafonnier; acier, bois, noir, marron

L 860, B 180, H 240



E27

3x 40W



9 002759 998561

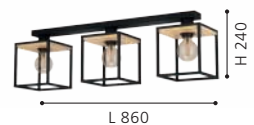



900349



900349 LIBERTAD 1

pendant light; steel, wood, black, brown
 Hängeleuchte; Stahl, Holz, schwarz, braun
 luminaire en suspension; acier, bois, noir, marron

L 760, B 140, H 1100



E27



3x 40W



9 008606 243501

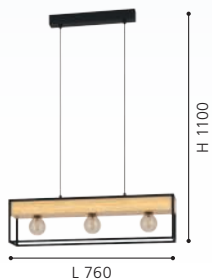

900349

The flower pots are included with this luminaire.

Bei dieser Leuchte sind die Blumentöpfe inkludiert.

Les pots de fleurs sont inclus avec ce luminaire.





99796



99798



99796 LIBERTAD

wall light; steel, wood, black, brown
Wandleuchte; Stahl, Holz, schwarz, braun
applique; acier, bois, noir, marron

L 140, H 240, A 165



E27 1x 40W



9 002759 997960



99798 LIBERTAD

floor light; steel, wood, black, brown
Stehleuchte; Stahl, Holz, schwarz, braun
lampadaire; acier, bois, noir, marron

L 180, B 180, H 1285

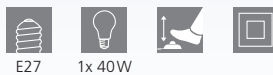

E27 1x 40W



9 002759 997984



99797 LIBERTAD

table light; steel, wood, black, brown
Tischleuchte; Stahl, Holz, schwarz, braun
luminaire de table; acier, bois, noir, marron

L 140, B 140, H 350

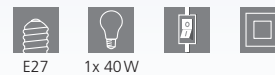

E27 1x 40W



9 002759 997977





99797





99293 CAMACHO

pendant light; steel, wood, black, brown / plastic, white
 Hängeleuchte; Stahl, Holz, schwarz, braun / Kunststoff, weiss
 luminaire en suspension; acier, bois, noir, marron / plastique, blanc

L 1100, B 60, H 1100

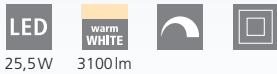

25,5W 3100lm



9 002759 992934

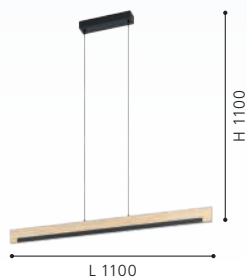

99292 CAMACHO

ceiling light; steel, wood, black, brown / plastic, white
 Deckenleuchte; Stahl, Holz, schwarz, braun / Kunststoff, weiss
 plafonnier; acier, bois, noir, marron / plastique, blanc

L 940, B 80, H 115



2x 10W 2600lm



9 002759 992927

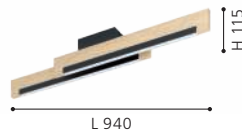

99294 CAMACHO

wall light; steel, wood, black, brown / plastic, white
 Wandleuchte; Stahl, Holz, schwarz, braun / Kunststoff, weiss
 applique; acier, bois, noir, marron / plastique, blanc

L 440, H 105, A 75



1x 9,6W 1050lm



9 002759 992941



TOUCH
ME



99296

LED



99295

LED

99295, 99296

These luminaires can be switched on and off by touching the specially designed "Touch Me" part of the fixture.

Diese Leuchten können ein- und ausgeschaltet werden, indem man sie an den dafür vorgesehenen "Touch Me" Bereichen berührt.

Ces luminaires peuvent être éteints et allumés simplement en touchant la partie spécialement conçue pour "Touch Me" du luminaire.

99296 CAMACHO

floor light; steel, wood, black, brown / plastic, white
Stehleuchte; Stahl, Holz, schwarz, braun / Kunststoff, weiss
lampadaire; acier, bois, noir, marron / plastique, blanc

L 75, B 20, H 1260, Base: B 250, T 200

LED

19,5 W

warm
WHITE

2400lm



9 002759 992965

99295 CAMACHO

table light; steel, wood, black, brown / plastic, white
Tischleuchte; Stahl, Holz, schwarz, braun / Kunststoff, weiss
luminaire de table; acier, bois, noir, marron / plastique, blanc

L 75, B 20, H 405, Base: B 150, T 130

LED

1x 6,5 W

warm
WHITE

800lm



9 002759 992958



99624 BOYAL

pendant light; steel, wood, black, brown rustic / plastic, white
 Hängeleuchte; Stahl, Holz, schwarz, braun rustikal / Kunststoff, weiss
 luminaire en suspension; acier, bois, noir, marron rustique / plastique, blanc

L 1010, B 400, H 1100

LED warm WHITE LED warm WHITE

2x 12,5W 3600lm 1x 15,5W 2250lm



9 002759 996246

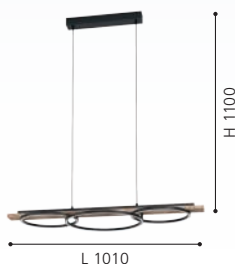

99413 BOYAL

ceiling light; steel, wood, black, brown rustic / plastic, white
 Deckenleuchte; Stahl, Holz, schwarz, braun rustikal / Kunststoff, weiss
 plafonnier; acier, bois, noir, marron rustique / plastique, blanc

L 1010, B 400, H 95

LED warm WHITE LED warm WHITE

2x 12W 3400lm 1x 12W 1700lm



9 002759 994136





99353



99457



99408



99353 BOYAL

wall light; steel, wood, black, brown rustic / plastic, white
Wandleuchte; Stahl, Holz, schwarz, braun rustikal / Kunststoff, weiss
applique; acier, bois, noir, marron rustique / plastique, blanc

L 300, H 560, A 75



1x 12W 1700lm



9 002759 993535



99457 BOYAL

table light; steel, wood, black, brown rustic / plastic, white
Tischleuchte; Stahl, Holz, schwarz, braun rustikal / Kunststoff, weiss
luminaire de table; acier, bois, noir, marron rustique / plastique, blanc

L 300, B 150, H 425, Base: B 110, T 150



1x 12W 1700lm



9 002759 994570



99408 BOYAL

ceiling light; steel, wood, black, brown rustic / plastic, white
Deckenleuchte; Stahl, Holz, schwarz, braun rustikal / Kunststoff, weiss
plafonnier; acier, bois, noir, marron rustique / plastique, blanc

L 780, B 400, H 90



1x 12W 1700lm 1x 12W 1700lm



9 002759 994082





99625 BOYAL

pendant light; steel, black, brown / plastic, white
 Hängeleuchte; Stahl, schwarz, braun / Kunststoff, weiss
 luminaire en suspension; acier, noir, marron / plastique, blanc

L 1010, B 400, H 1100

LED warm WHITE LED warm WHITE

2x 12,5W 3600lm 1x 15,5W 2250lm



9 002759 996253



99468 BOYAL

ceiling light; steel, wood, black, brown / plastic, white
 Deckenleuchte; Stahl, Holz, schwarz, braun / Kunststoff, weiss
 plafonnier; acier, bois, noir, marron / plastique, blanc

L 1010, B 400, H 95

LED warm WHITE LED warm WHITE

2x 12W 3400lm 1x 12W 1700lm



9 002759 994686

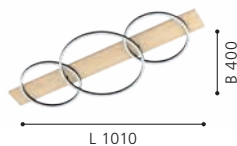

99467 BOYAL

ceiling light; steel, wood, black, brown / plastic, white
 Deckenleuchte; Stahl, Holz, schwarz, braun / Kunststoff, weiss
 plafonnier; acier, bois, noir, marron / plastique, blanc

L 780, B 400, H 90

LED warm WHITE LED warm WHITE

1x 12W 1700lm 1x 12W 1700lm



9 002759 994679

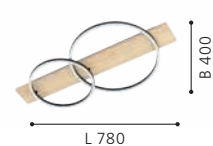



99469

LED



99466

LED

99469 BOYAL

table light; steel, wood, black, brown / plastic, white
Tischleuchte; Stahl, Holz, schwarz, braun / Kunststoff, weiss
luminaire de table; acier, bois, noir, marron / plastique, blanc

L 300, B 150, H 425, Base: B 110, T 150



1x 12W 1700lm



9 002759 994693



99466 BOYAL

wall light; steel, wood, black, brown / plastic, white
Wandleuchte; Stahl, Holz, schwarz, braun / Kunststoff, weiss
applique; acier, bois, noir, marron / plastique, blanc

L 300, H 560, A 75



1x 12W 1700lm



9 002759 994662

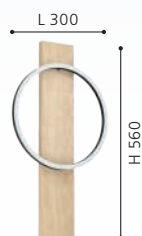



900489



900488



900491



900489 PANAGRIA

pendant light; aluminium, steel, wood, black, brown / plastic, white

Hängeleuchte; Alu, Stahl, Holz, schwarz, braun / Kunststoff, weiss

luminaire en suspension; aluminium, acier, bois, noir, marron / plastique, blanc

L 935, B 75, H 1100



2x 13W 3120lm



9 008606 244249

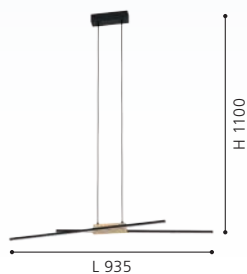

900488 PANAGRIA

ceiling light; aluminium, steel, wood, black, brown / plastic, white

Deckenleuchte; Alu, Stahl, Holz, schwarz, braun / Kunststoff, weiss

plafonnier; aluminium, acier, bois, noir, marron / plastique, blanc

L 935, B 75, H 110



2x 13W 3120lm



9 008606 244232

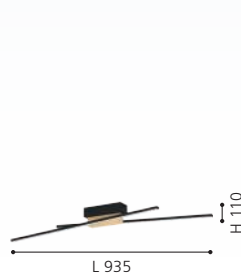

900491 PANAGRIA

wall light; aluminium, steel, wood, black, brown / plastic, white

Wandleuchte; Alu, Stahl, Holz, schwarz, braun / Kunststoff, weiss

applique; aluminium, acier, bois, noir, marron / plastique, blanc

L 75, H 540, A 85



2x 6,3W 1510lm



9 008606 244256



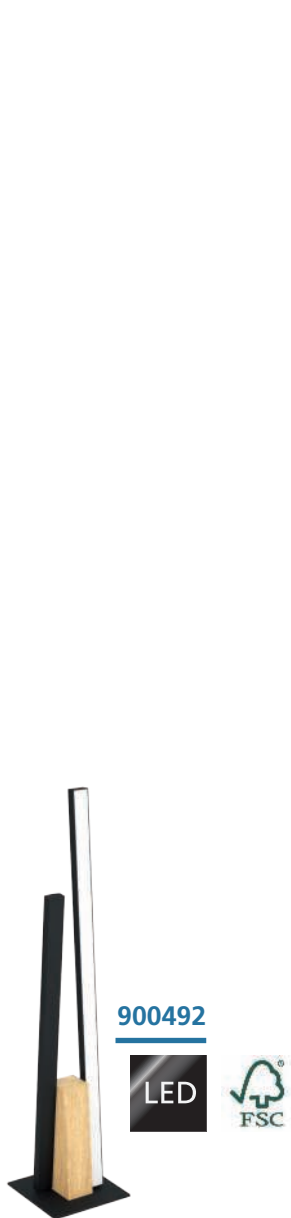

900492



900493



DESIGN
HIGHLIGHT
DETAIL

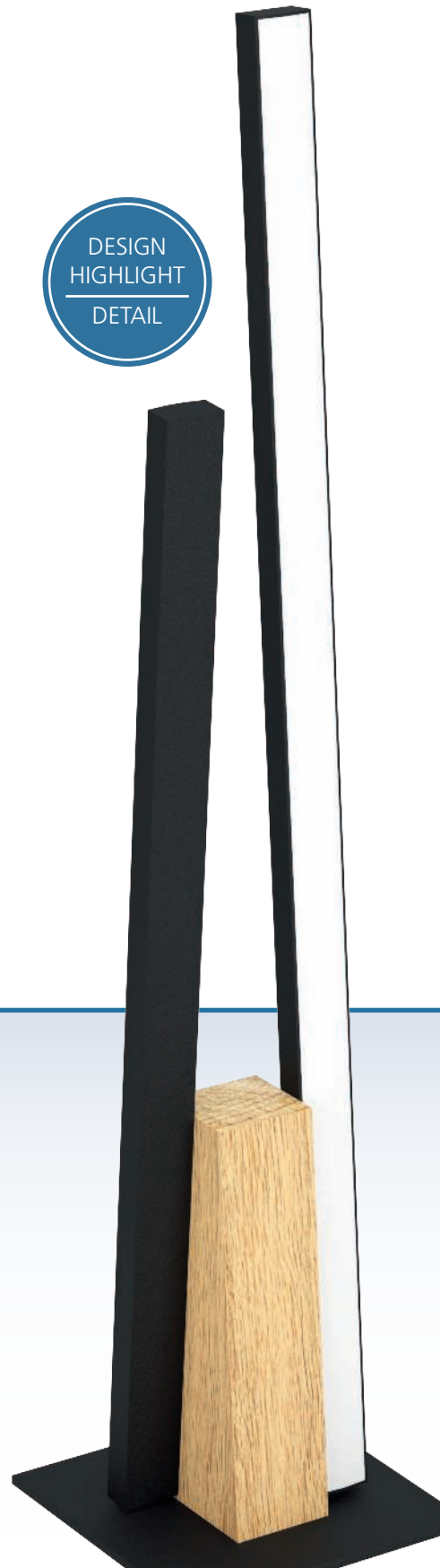

900492 PANAGRIA

table light; aluminium, steel, wood, black, brown / plastic, white
Tischleuchte; Alu, Stahl, Holz, schwarz, braun / Kunststoff, weiss
luminaire de table; aluminium, acier, bois, noir, marron /
plastique, blanc

L 75, B 45, H 455, Base: B 100, T 100



1x 6,8W



1440lm



1x 5,2W



9 008606 244263



900493 PANAGRIA

floor light; aluminium, steel, wood, black, brown / plastic, white
Stehleuchte; Alu, Stahl, Holz, schwarz, braun / Kunststoff, weiss
lampadaire; aluminium, acier, bois, noir, marron / plastique,
blanc

L 85, B 75, H 1460, Base: B 160, T 160



1x 12,8W



2880lm



1x 11,2W



9 008606 244270





99545

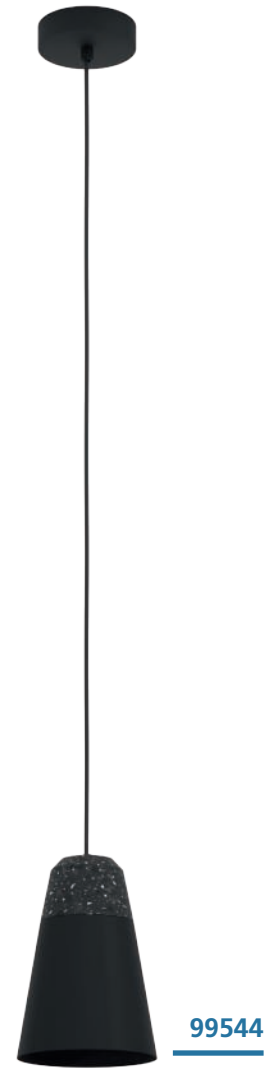

99544

99545 CANTERRAS

pendant light; steel, black / terrazzo, grey, white
 Hängeleuchte; Stahl, schwarz / Terrazzo, grau, weiss
 luminaire en suspension; acier, noir / terrazzo, gris, blanc

L 975, B 150, H 1100



99544 CANTERRAS

pendant light; steel, black / terrazzo, grey, white
 Hängeleuchte; Stahl, schwarz / Terrazzo, grau, weiss
 luminaire en suspension; acier, noir / terrazzo, gris, blanc

H 1100, Ø 150

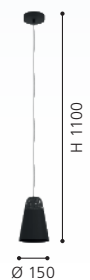
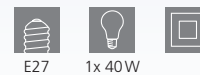



99546



99547



99546 CANTERRAS

wall light; steel, black / terrazzo, grey, white
Wandleuchte; Stahl, schwarz / Terrazzo, grau, weiss
applique; acier, noir / terrazzo, gris, blanc

L 150, H 320, A 275



9 002759 995461



99547 CANTERRAS

floor light; steel, black / terrazzo, grey, white
Stehleuchte; Stahl, schwarz / Terrazzo, grau, weiss
lampadaire; acier, noir / terrazzo, gris, blanc

L 430, B 150, H 1785, Base: Ø 300

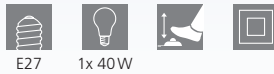

9 002759 995478



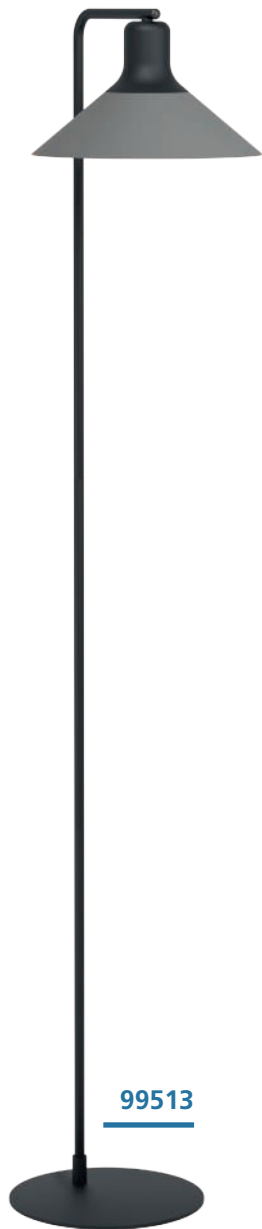

99513



99512

99513 ABREOSA

floor light; steel, black, grey
 Stehleuchte; Stahl, schwarz, grau
 lampadaire; acier, noir, gris

L 370, B 280, H 1510, Base: Ø 250

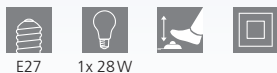

E27

1x 28W



9 002759 995133

99512 ABREOSA

pendant light; steel, black, grey
 Hängeleuchte; Stahl, schwarz, grau
 luminaire en suspension; acier, noir, gris

L 1080, B 280, H 1100



E27

3x 28W



9 002759 995126

99511 ABREOSA

pendant light; steel, black, grey
 Hängeleuchte; Stahl, schwarz, grau
 luminaire en suspension; acier, noir, gris

H 1100, Ø 280



E27

1x 28W

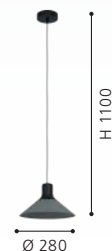

9 002759 995119

99511





99551

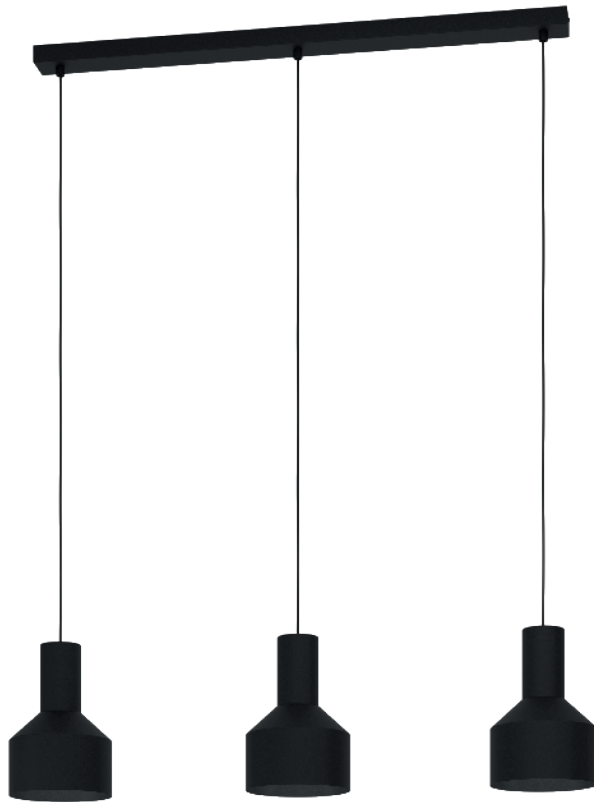

99552



99553

99551 CASIBARE

pendant light; steel, black
Hängeleuchte; Stahl, schwarz
luminaire en suspension; acier, noir

H 1100, Ø 150

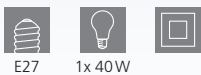

9 002759 995515



99552 CASIBARE

pendant light; steel, black
Hängeleuchte; Stahl, schwarz
luminaire en suspension; acier, noir

L 850, B 150, H 1100



9 002759 995522



99553 CASIBARE

pendant light; steel, black
Hängeleuchte; Stahl, schwarz
luminaire en suspension; acier, noir

H 1500, Ø 710



9 002759 995539





99554



99555

99554 CASIBARE

table light; steel, black
Tischleuchte; Stahl, schwarz
luminaire de table; acier, noir

L 160, B 120, H 490, Base: Ø 155

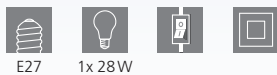

E27 1x 28W



9 002759 995546



99555 CASIBARE

floor light; steel, black
Stehleuchte; Stahl, schwarz
lampadaire; acier, noir

L 350, B 120, H 1605, Base: Ø 250

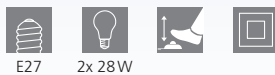

E27 2x 28W



9 002759 995553





99345



900164

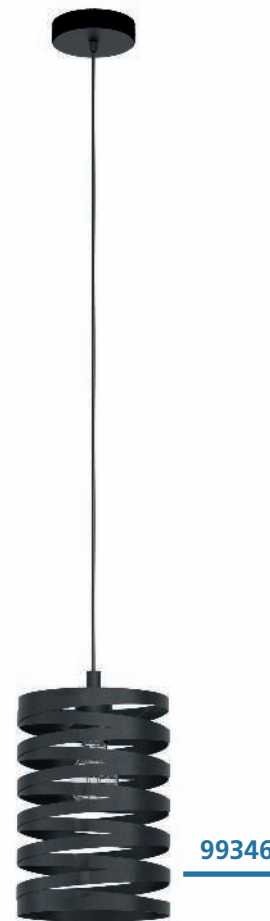

99346

99345 CREMELLA

pendant light; steel, black
Hängeleuchte; Stahl, schwarz
luminaire en suspension; acier, noir

H 1100, Ø 370



E27

1x 40W



9 002759 993450



900164 CREMELLA

ceiling light; steel, black
Deckenleuchte; Stahl, schwarz
plafonnier; acier, noir

H 260, Ø 370



E27

1x 60W



9 008606 234417

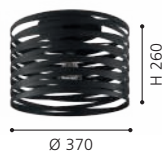

99346 CREMELLA

pendant light; steel, black
Hängeleuchte; Stahl, schwarz
luminaire en suspension; acier, noir

H 1100, Ø 180



E27

1x 40W



9 002759 993467





99347 CREMELLA

pendant light; steel, black
 Hängeleuchte; Stahl, schwarz
 luminaire en suspension; acier, noir

L 940, B 180, H 1100

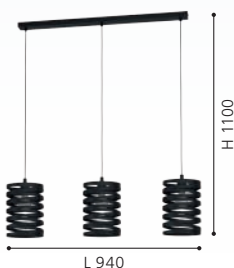

99506 CREMELLA

table light; steel, black
 Tischleuchte; Stahl, schwarz
 luminaire de table; acier, noir

H 290, Ø 180, Base: Ø 180

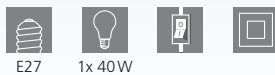

99507 CREMELLA

floor light; steel, black
 Stehleuchte; Stahl, schwarz
 lampadaire; acier, noir

H 1510, Ø 370, Base: Ø 250

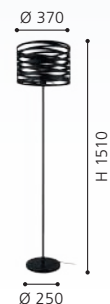
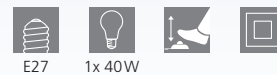



900494



900495

900494 ROMAZZINA

pendant light; steel, black
Hängeleuchte; Stahl, schwarz
luminaire en suspension; acier, noir

H 1100, Ø 325



E27 1x 40W



9 008606 244287



900495 ROMAZZINA

pendant light; steel, black
Hängeleuchte; Stahl, schwarz
luminaire en suspension; acier, noir

L 900, B 200, H 1100



E27 3x 40W



9 008606 244294



900519 ROMAZZINA

table light; steel, black
Tischleuchte; Stahl, schwarz
luminaire de table; acier, noir

H 435, Ø 200, Base: Ø 225



E27 1x 40W



9 008606 244485





900519



900522

900522 ROMAZZINA

floor light; steel, black
Stehleuchte; Stahl, schwarz
lampadaire; acier, noir

H 1405, Ø 325, Base: Ø 630



E27



1x 40W



9 008606 244508

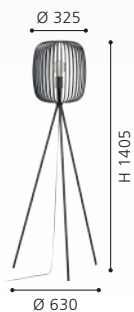



900496



900496 ROMAZZINA

pendant light; steel, sandy
Hängeleuchte; Stahl, sandfarben
luminaire en suspension; acier, couleur sable

H 1100, Ø 325



E27



1x 40W





900497



900521



900523

900497 ROMAZZINA

pendant light; steel, sandy
Hängeleuchte; Stahl, sandfarben
luminaire en suspension; acier, couleur sable

L 900, B 200, H 1100



E27 3x 40W



9 008606 244317



900521 ROMAZZINA

table light; steel, sandy
Tischleuchte; Stahl, sandfarben
luminaire de table; acier, couleur sable

H 435, Ø 200, Base: Ø 225



E27 1x 40W



9 008606 244492



900523 ROMAZZINA

floor light; steel, sandy
Stehleuchte; Stahl, sandfarben
lampadaire; acier, couleur sable

H 1405, Ø 325, Base: Ø 630



E27 1x 40W



9 008606 244515

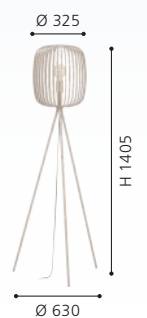



900165

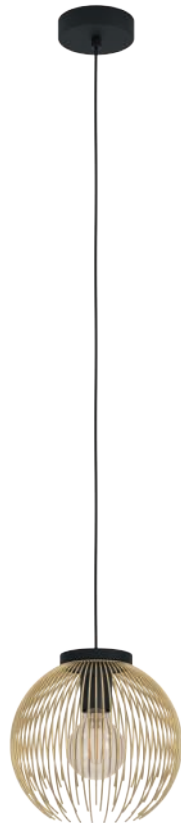

900166



900167

900165 VENEZUELA

ceiling light; steel, black, gold
Deckenleuchte; Stahl, schwarz, gold
plafonnier; acier, noir, or

H 250, Ø 385



E27 1x 40W



9 008606 242771



900166 VENEZUELA

pendant light; steel, black, gold
Hängeleuchte; Stahl, schwarz, gold
luminaire en suspension; acier, noir, or

H 1100, Ø 235

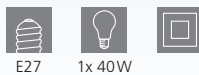

E27 1x 40W



9 008606 242788



900167 VENEZUELA

pendant light; steel, black, gold
Hängeleuchte; Stahl, schwarz, gold
luminaire en suspension; acier, noir, or

L 935, B 235, H 1100



E27 3x 40W



9 008606 242795





900168

900168 VENEZUELA

table light; steel, black, gold
Tischleuchte; Stahl, schwarz, gold
luminaire de table; acier, noir, or

H 225, Ø 235, Base: Ø 115



E27



1x 40W



9 008606 242801

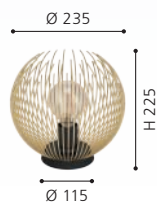



99806



99807



99809

99806 ESCANDIDOS

pendant light; steel, black, brass / steel, black, gold
Hängeleuchte; Stahl, schwarz, messing / Stahl, schwarz, gold
luminaire en suspension; acier, noir, laiton / acier, noir, or

H 1100, Ø 220



E27 1x 40W



9 002759 998066



99807 ESCANDIDOS

pendant light; steel, black, brass / steel, black, gold
Hängeleuchte; Stahl, schwarz, messing / Stahl, schwarz, gold
luminaire en suspension; acier, noir, laiton / acier, noir, or

L 920, B 220, H 1100



E27 3x 40W



9 002759 998073



99809 ESCANDIDOS

floor light; steel, black, brass / steel, black, gold
Stehleuchte; Stahl, schwarz, messing / Stahl, schwarz, gold
lampadaire; acier, noir, laiton / acier, noir, or

L 310, B 220, H 1700, Base: B 300, T 200

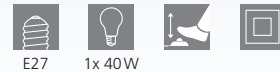

E27 1x 40W



9 002759 998097

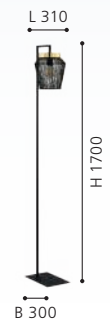



99808

99808 ESCANDIDOS

table light; steel, black, brass / steel, black, gold
Tischleuchte; Stahl, schwarz, messing / Stahl, schwarz, gold
luminaire de table; acier, noir, laiton / acier, noir, or

H 260, Ø 220, Base: Ø 150



E27



1x 40W



9 002759 998080





900177



DESIGN
HIGHLIGHT
DETAIL

900177 LURONE

pendant light; steel, black, brass
Hängeleuchte; Stahl, schwarz, messing
luminaire en suspension; acier, noir, laiton

L 1000, B 50, H 1100



E27



4x 10W



9 008606 241132

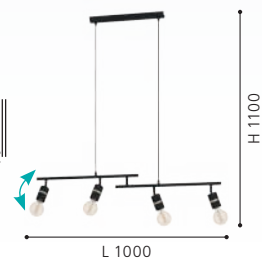



900176



900178



900179

900176 LURONE

ceiling light; steel, black, brass
Deckenleuchte; Stahl, schwarz, messing
plafonnier; acier, noir, laiton

L 1000, B 50, H 270



9 008606 241125

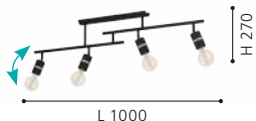

900178 LURONE

table light; steel, black, brass
Tischleuchte; Stahl, schwarz, messing
luminaire de table; acier, noir, laiton

L 205, B 50, H 500, Base: Ø 200



9 008606 241149



900179 LURONE

floor light; steel, black, brass
Stehleuchte; Stahl, schwarz, messing
lampadaire; acier, noir, laiton

L 205, B 50, H 1600, Base: Ø 250



9 008606 241156

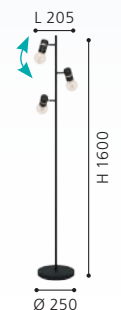



99592



DESIGN
HIGHLIGHT
DETAIL

99592 NARICES

pendant light; steel, black / steel, brushed brass, gold
Hängeleuchte; Stahl, schwarz / Stahl, messing-gebürstet, gold
luminaire en suspension; acier, noir / acier, laiton brossé, or

L 920, B 220, H 1100



E27



3x 40W

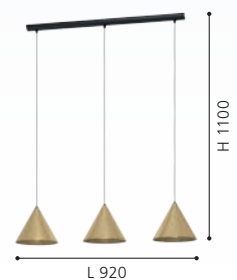

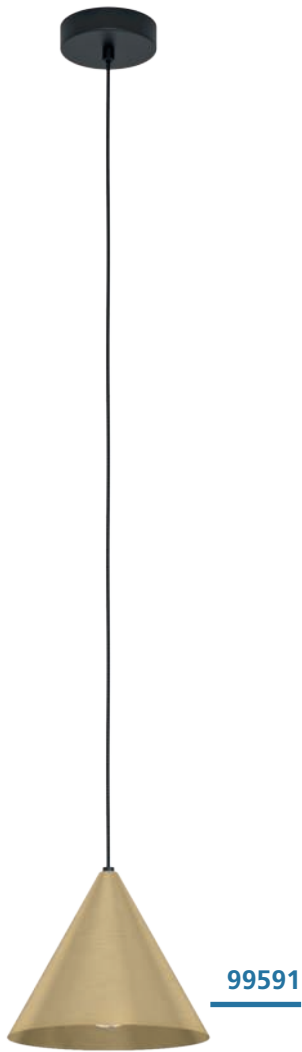

99591



99593



99594

99591 NARICES

pendant light; steel, black / steel, brushed brass, gold
 Hängeleuchte; Stahl, schwarz / Stahl, messing-gebürstet, gold
 luminaire en suspension; acier, noir / acier, laiton brossé, or

H 1100, Ø 220



E27 1x 40W



9 002759 995911



99593 NARICES

table light; steel, black / steel, brushed brass, gold
 Tischleuchte; Stahl, schwarz / Stahl, messing-gebürstet, gold
 luminaire de table; acier, noir / acier, laiton brossé, or

L 295, B 220, H 500, Base: Ø 220



E27 1x 40W



9 002759 995935



99594 NARICES

floor light; steel, black / steel, brushed brass, gold
 Stehleuchte; Stahl, schwarz / Stahl, messing-gebürstet, gold
 lampadaire; acier, noir / acier, laiton brossé, or

L 295, B 220, H 1620, Base: Ø 270

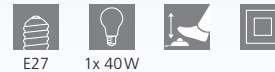

E27 1x 40W



9 002759 995942





99098



99096



99097

99098 ERSEKA

pendant light; steel, brass / crystal, clear
 Hängeleuchte; Stahl, messing / Kristall, klar
 luminaire en suspension; acier, laiton / cristal, transparent

H 1300, Ø 385



E14 5x 40W



99097 ERSEKA

pendant light; steel, brass / crystal, clear
 Hängeleuchte; Stahl, messing / Kristall, klar
 luminaire en suspension; acier, laiton / cristal, transparent

H 1450, Ø 485



E14 7x 40W



99096 ERSEKA

ceiling light; steel, brass / crystal, clear
 Deckenleuchte; Stahl, messing / Kristall, klar
 plafonnier; acier, laiton / cristal, transparent

H 535, Ø 485



E14 7x 40W

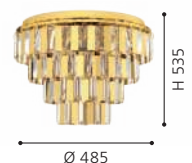



99095



99093



99094



ERSEKA

99095 ERSEKA

pendant light; steel, chrome / crystal, clear
 Hängeleuchte; Stahl, chrom / Kristall, klar
 luminaire en suspension; acier, chrome / cristal, transparent

H 1300, Ø 385



E14 5x 40W



9 002759 990954



99094 ERSEKA

pendant light; steel, chrome / crystal, clear
 Hängeleuchte; Stahl, chrom / Kristall, klar
 luminaire en suspension; acier, chrome / cristal, transparent

H 1450, Ø 485



E14 7x 40W



9 002759 990947



99093 ERSEKA

ceiling light; steel, chrome / crystal, clear
 Deckenleuchte; Stahl, chrom / Kristall, klar
 plafonnier; acier, chrome / cristal, transparent

H 535, Ø 485



E14 7x 40W



9 002759 990930

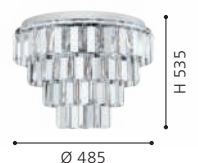



900305



MANZANARES

900305 MANZANARES

pendant light; steel, brushed brass, gold / glass opal-matt, white
Hängeleuchte; Stahl, messing-gebürstet, gold / Glas opal-matt, weiss

luminaire en suspension; acier, laiton brossé, or / verre opale mat, blanc

H 1100, Ø 225



E27



1x 40W



9 008606 235902

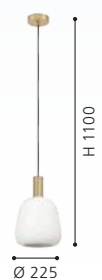



900306



900304



900307

900306 MANZANARES

pendant light; steel, brushed brass, gold / glass opal-matt, white
Hängeleuchte; Stahl, messing-gebürstet, gold / Glas opal-matt, weiss

luminaire en suspension; acier, laiton brossé, or / verre opale mat, blanc

L 970, B 145, H 1100



E27 4x 40W



9 008606 235919

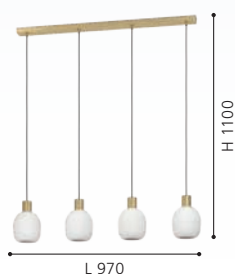

L 970

H 1100

900304 MANZANARES

ceiling light; steel, brushed brass, gold / glass opal-matt, white
Deckenleuchte; Stahl, messing-gebürstet, gold / Glas opal-matt, weiss

plafonnier; acier, laiton brossé, or / verre opale mat, blanc

H 190, Ø 450



E27 3x 40W



9 008606 235896

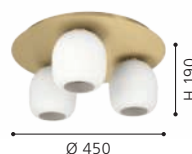

Ø 450

H 190

900307 MANZANARES

table light; steel, brushed brass, gold / glass opal-matt, white
Tischleuchte; Stahl, messing-gebürstet, gold / Glas opal-matt, weiss

luminaire de table; acier, laiton brossé, or / verre opale mat, blanc

H 180, Ø 145, Base: Ø 90

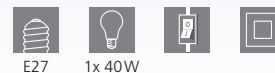

E27 1x 40W



9 008606 235926



Ø 90

H 180



85261



85262

85261 RONDO

pendant light; steel, satin nickel / glass opal-matt, white
 Hängeleuchte; Stahl, nickel-matt / Glas opal-matt, weiss
 luminaire en suspension; acier, nickel mat / verre opale mat, blanc

H 1100, Ø 200



9 002759 852610



85262 RONDO

pendant light; steel, satin nickel / glass opal-matt, white
 Hängeleuchte; Stahl, nickel-matt / Glas opal-matt, weiss
 luminaire en suspension; acier, nickel mat / verre opale mat, blanc

H 1100, Ø 250



9 002759 852627

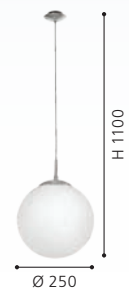



85263 RONDO

pendant light; steel, satin nickel / glass opal-matt, white
Hängeleuchte; Stahl, nickel-matt / Glas opal-matt, weiss
luminaire en suspension; acier, nickel mat / verre opale mat, blanc

H 1100, Ø 300



91589 RONDO

ceiling light; steel, satin nickel / glass opal-matt, white
Deckenleuchte; Stahl, nickel-matt / Glas opal-matt, weiss
plafonnier; acier, nickel mat / verre opale mat, blanc

H 315, Ø 250



85264 RONDO

table light; plastic, white / glass opal-matt, white
Tischleuchte; Kunststoff, weiss / Glas opal-matt, weiss
luminaire de table; plastique, blanc / verre opale mat, blanc

H 200, Ø 200

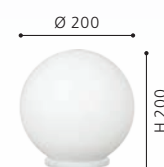
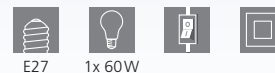



900395

900512

The flower pots are included with this luminaire.

Die Blumentöpfe sind bei dieser Leuchte inkludiert.

Les pots de fleurs sont inclus avec ce luminaire.

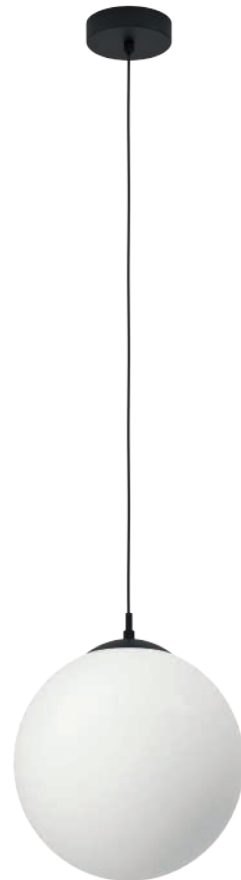

900511

900395 RONDO

pendant light; steel, satin nickel / glass opal-matt, white
 Hängeleuchte; Stahl, nickel-matt / Glas opal-matt, weiss
 luminaire en suspension; acier, nickel mat / verre opale mat, blanc

L 960, B 200, H 1100



E27

3x 40W

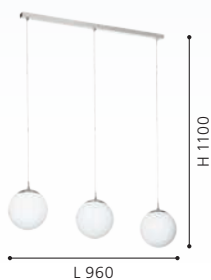

9 008606 239467

900511 RONDO 3

pendant light; steel, black / glass opal-matt, white
 Hängeleuchte; Stahl, schwarz / Glas opal-matt, weiss
 luminaire en suspension; acier, noir / verre opale mat, blanc

H 1100, Ø 300



E27

1x 40W



9 008606 244409

900512 RONDO 3

pendant light; steel, black / glass opal-matt, white
 Hängeleuchte; Stahl, schwarz / Glas opal-matt, weiss
 luminaire en suspension; acier, noir / verre opale mat, blanc

L 1210, B 200, H 1100



E27

3x 40W

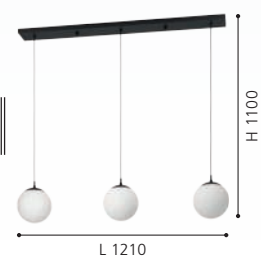

9 008606 244416



900512



86811



86812



OPTICA



86816

86811 OPTICA

wall / ceiling light; steel, satin nickel / glass opal-matt, white
Wand- / Deckenleuchte; Stahl, nickel-matt / Glas opal-matt, weiss
applique / plafonnier; acier, nickel mat / verre opale mat, blanc

H 160, Ø 280

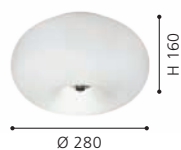

86812 OPTICA

wall / ceiling light; steel, satin nickel / glass opal-matt, white
Wand- / Deckenleuchte; Stahl, nickel-matt / Glas opal-matt, weiss
applique / plafonnier; acier, nickel mat / verre opale mat, blanc

H 210, Ø 350

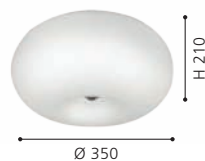

86816 OPTICA

table light; steel, satin nickel / glass opal-matt, white
Tischleuchte; Stahl, nickel-matt / Glas opal-matt, weiss
luminaire de table; acier, nickel mat / verre opale mat, blanc

H 460, Ø 280, Base: Ø 195



86817 OPTICA

floor light; steel, satin nickel / glass opal-matt, white
Stehleuchte; Stahl, nickel-matt / Glas opal-matt, weiss
lampadaire; acier, nickel mat / verre opale mat, blanc

H 1570, Ø 350



E27



2x 60W



9 002759 868178

Ø 350

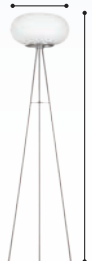

H 1570



86817

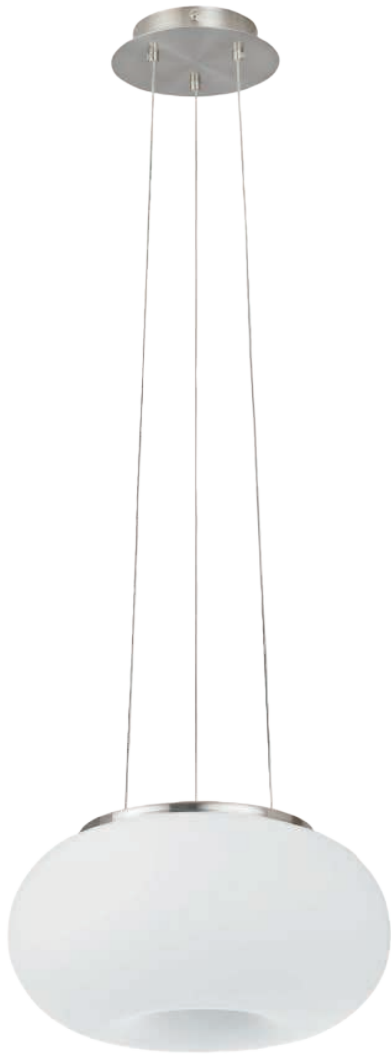

86813



86814



86813 OPTICA

pendant light; steel, satin nickel / glass opal-matt, white
 Hängeleuchte; Stahl, nickel-matt / Glas opal-matt, weiss
 luminaire en suspension; acier, nickel mat / verre opale mat, blanc

H 1100, Ø 280



86814 OPTICA

pendant light; steel, satin nickel / glass opal-matt, white
 Hängeleuchte; Stahl, nickel-matt / Glas opal-matt, weiss
 luminaire en suspension; acier, nickel mat / verre opale mat, blanc

H 1100, Ø 350



86815 OPTICA

pendant light; steel, satin nickel / glass opal-matt, white
 Hängeleuchte; Stahl, nickel-matt / Glas opal-matt, weiss
 luminaire en suspension; acier, nickel mat / verre opale mat, blanc

H 1100, Ø 445

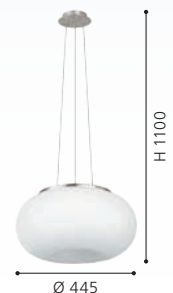



86815



99631



99632



DESIGN
HIGHLIGHT
DETAIL



33984

99631 GOROSIBA 1

ceiling light; steel, black / glass vaporized, black-transparent
Deckenleuchte; Stahl, schwarz / Glas bedampft, schwarz-transparent
plafonnier; acier, noir / verre vaporisé, noir transparent

H 175, Ø 450



E27 3x 40W

99632 GOROSIBA 1

ceiling light; steel, black / glass vaporized, black-transparent
Deckenleuchte; Stahl, schwarz / Glas bedampft, schwarz-transparent
plafonnier; acier, noir / verre vaporisé, noir transparent

L 380, B 380, H 170



E27 4x 40W

33984 GOROSIBA

table light; steel, black / glass vaporized, black-transparent
Tischleuchte; Stahl, schwarz / Glas bedampft, schwarz-transparent
luminaire de table; acier, noir / verre vaporisé, noir transparent

H 220, Ø 150, Base: Ø 100

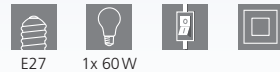

E27 1x 60W



9 002759 996314



9 002759 996321



9 002759 339845





98752 GOROSIBA

pendant light; steel, black / glass vaporized, black-transparent
 Hängeleuchte; Stahl, schwarz / Glas bedampft, schwarz-transparent
 luminaire en suspension; acier, noir / verre vaporisé, noir transparent

H 1100, Ø 150



98753 GOROSIBA

pendant light; steel, black / glass vaporized, black-transparent
 Hängeleuchte; Stahl, schwarz / Glas bedampft, schwarz-transparent
 luminaire en suspension; acier, noir / verre vaporisé, noir transparent

L 850, B 150, H 1100



98754 GOROSIBA

pendant light; steel, black / glass vaporized, black-transparent
 Hängeleuchte; Stahl, schwarz / Glas bedampft, schwarz-transparent
 luminaire en suspension; acier, noir / verre vaporisé, noir transparent

H 1300, Ø 410



DESIGN
HIGHLIGHT
DETAIL



900341

900341 PINTO TEXTIL 1

pendant light; steel, black / glass, fabric, clear, black
Hängeleuchte; Stahl, schwarz / Glas, Textil, klar, schwarz
luminaire en suspension; acier, noir / verre, tissu, transparent, noir

H 1100, Ø 120



900342 PINTO TEXTIL 1

pendant light; steel, black / glass, fabric, clear, black
Hängeleuchte; Stahl, schwarz / Glas, Textil, klar, schwarz
luminaire en suspension; acier, noir / verre, tissu, transparent, noir

L 820, B 120, H 1100





900342



99288



99288



99286

99288 PINTO TEXTIL

wall light; steel, satin nickel / glass, fabric, clear, grey
 Wandleuchte; Stahl, nickel-matt / Glas, Textil, klar, grau
 applique; acier, nickel mat / verre, tissu, transparent, gris

L 120, H 445, A 180



9 002759 992880



99286 PINTO TEXTIL

pendant light; steel, satin nickel / glass, fabric, clear, grey
 Hängeleuchte; Stahl, nickel-matt / Glas, Textil, klar, grau
 luminaire en suspension; acier, nickel mat / verre, tissu, transparent, gris

L 820, B 120, H 1100



9 002759 992866





99286 | 99287



99287

99287 PINTO TEXTIL

pendant light; steel, satin nickel / glass, fabric, clear, grey
 Hängeleuchte; Stahl, nickel-matt / Glas, Textil, klar, grau
 luminaire en suspension; acier, nickel mat / verre, tissu, transparent, gris

L 945, B 120, H 1100



9 002759 992873





90304



PINTO NERO

90304 PINTO NERO

pendant light; steel, satin nickel / smoked glass, glass opal-matt, black-transparent, white

Hängeleuchte; Stahl, nickel-matt / Rauchglas, Glas opal-matt, schwarz-transparent, weiss

luminaire en suspension; acier, nickel mat / verre fumé, verre opale mat, noir transparent, blanc

H 1100, Ø 110



E27



1x 40W



9 002759 903046



90305 PINTO NERO

pendant light; steel, satin nickel / smoked glass, glass opal-matt, black-transparent, white

Hängeleuchte; Stahl, nickel-matt / Rauchglas, Glas opal-matt, schwarz-transparent, weiss

luminaire en suspension; acier, nickel mat / verre fumé, verre opale mat, noir transparent, blanc

L 725, H 1100



E27



3x 40W



9 002759 903053

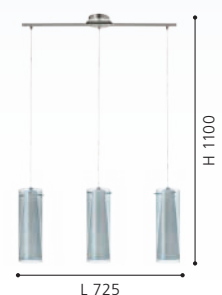



90305



97653



97839

97651

97653 PINTO GOLD

pendant light; steel, black / glass, clear, gold
 Hängeleuchte; Stahl, schwarz / Glas, klar, gold
 luminaire en suspension; acier, noir / verre, transparent, or

L 905, B 360, H 1100



E27



4x 40W



9 002759 976538

97651 PINTO GOLD

pendant light; steel, black / glass, clear, gold
 Hängeleuchte; Stahl, schwarz / Glas, klar, gold
 luminaire en suspension; acier, noir / verre, transparent, or

H 1100, Ø 110



E27



1x 40W



9 002759 976514

97839 PINTO GOLD

wall light; steel, black / glass, clear, gold
 Wandleuchte; Stahl, schwarz / Glas, klar, gold
 applique; acier, noir / verre, transparent, or

L 110, H 270, A 150



E27



1x 40W



9 002759 978396



97652



97655



PINTO GOLD



DESIGN
HIGHLIGHT
DETAIL



97652 PINTO GOLD

pendant light; steel, black / glass, clear, gold
Hängeleuchte; Stahl, schwarz / Glas, klar, gold
luminaire en suspension; acier, noir / verre, transparent, or

L 725, B 110, H 1100

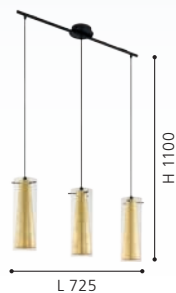

97655 PINTO GOLD

floor light; steel, black, gold / glass, clear, gold
Stehleuchte; Stahl, schwarz, gold / Glas, klar, gold
lampadaire; acier, noir, or / verre, transparent, or

H 1470, Ø 110, Base: Ø 230

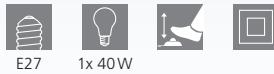

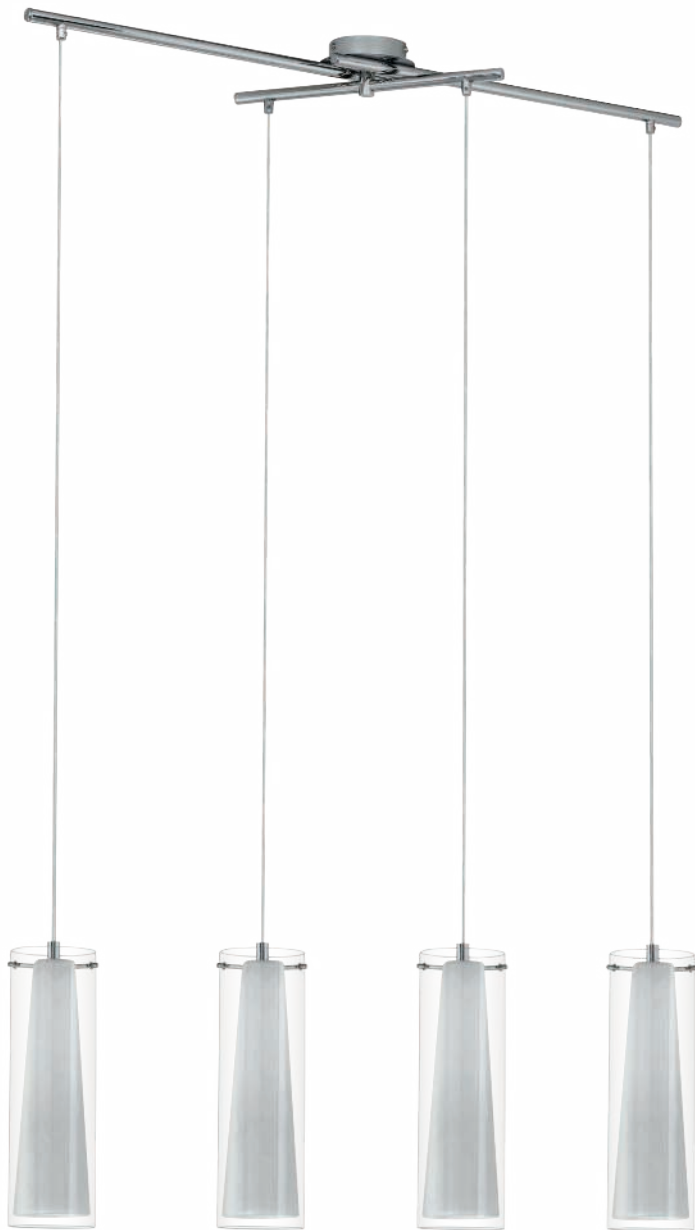

89832 | 89833 | 89834 |
89835 | 89836



89832

89834

89835



89834 PINTO

pendant light; steel, chrome / glass, glass opal-matt, clear, white
Hängeleuchte; Stahl, chrom / Glas, Glas opal-matt, klar, weiss
luminaire en suspension; acier, chrome / verre, verre opale mat, transparent, blanc

L 905, B 360, H 1100



E27

4x 40W



9 002759 898342

89835 PINTO

table light; steel, chrome / glass, glass opal-matt, clear, white
Tischleuchte; Stahl, chrom / Glas, Glas opal-matt, klar, weiss
luminaire de table; acier, chrome / verre, verre opale mat, transparent, blanc

H 500, Ø 110, Base: Ø 155



E27

1x 40W



9 002759 898359

89832 PINTO

pendant light; steel, chrome / glass, glass opal-matt, clear, white
Hängeleuchte; Stahl, chrom / Glas, Glas opal-matt, klar, weiss
luminaire en suspension; acier, chrome / verre, verre opale mat, transparent, blanc

H 1100, Ø 110



E27

1x 40W

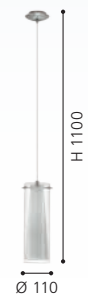

9 002759 898328



93003



89833



89836

93003 PINTO

pendant light; steel, chrome / glass, glass opal-matt, clear, white
 Hängeleuchte; Stahl, chrom / Glas, Glas opal-matt, klar, weiss
 luminaire en suspension; acier, chrome / verre, verre opale mat, transparent, blanc

H 1500, Ø 500



E27 5x 40W



9 002759 930035



89833 PINTO

pendant light; steel, chrome / glass, glass opal-matt, clear, white
 Hängeleuchte; Stahl, chrom / Glas, Glas opal-matt, klar, weiss
 luminaire en suspension; acier, chrome / verre, verre opale mat, transparent, blanc

L 725, H 1100



E27 3x 40W



9 002759 898335



89836 PINTO

floor light; steel, chrome / glass, glass opal-matt, clear, white
 Stehleuchte; Stahl, chrom / Glas, Glas opal-matt, klar, weiss
 lampadaire; acier, chrome / verre, verre opale mat, transparent, blanc

H 1470, Ø 110, Base: Ø 230

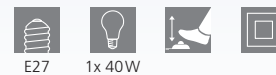

E27 1x 40W



9 002759 898366

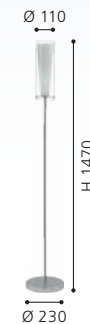



85978



85977

85978 TROY 3

pendant light; steel, satin nickel / satin glass, white painted
 Hängeleuchte; Stahl, nickel-matt / Glas satiniert, weiss lackiert
 luminaire en suspension; acier, nickel mat / verre satiné, blanc laqué

L 720, B 105, H 1100



E27



3x 40W



9 002759 859787



85977 TROY 3

pendant light; steel, satin nickel / satin glass, white painted
 Hängeleuchte; Stahl, nickel-matt / Glas satiniert, weiss lackiert
 luminaire en suspension; acier, nickel mat / verre satiné, blanc laqué

H 1100, Ø 110



E27



1x 40W



9 002759 859770



85979 TROY 3

wall light; steel, satin nickel / satin glass, white
 Wandleuchte; Stahl, nickel-matt / Glas satiniert, weiss
 applique; acier, nickel mat / verre satiné, blanc laqué

L 180, H 250, A 75



E14



1x 60W



9 002759 859794





85979



85979



85981



85977 | 85978 | 85981 |
85982

85981 TROY 3

table light; steel, satin nickel / satin glass, white painted
Tischleuchte; Stahl, nickel-matt / Glas satiniert, weiss lackiert
luminaire de table; acier, nickel mat / verre satiné, blanc laqué

H 460, Ø 105, Base: Ø 120



E27 1x 40W



9 002759 859817



85982 TROY 3

floor light; steel, satin nickel / satin glass, white painted
Stehleuchte; Stahl, nickel-matt / Glas satiniert, weiss lackiert
lampadaire; acier, nickel mat / verre satiné, blanc laqué

H 1530, Ø 105, Base: Ø 200



E27 1x 40W



9 002759 859824

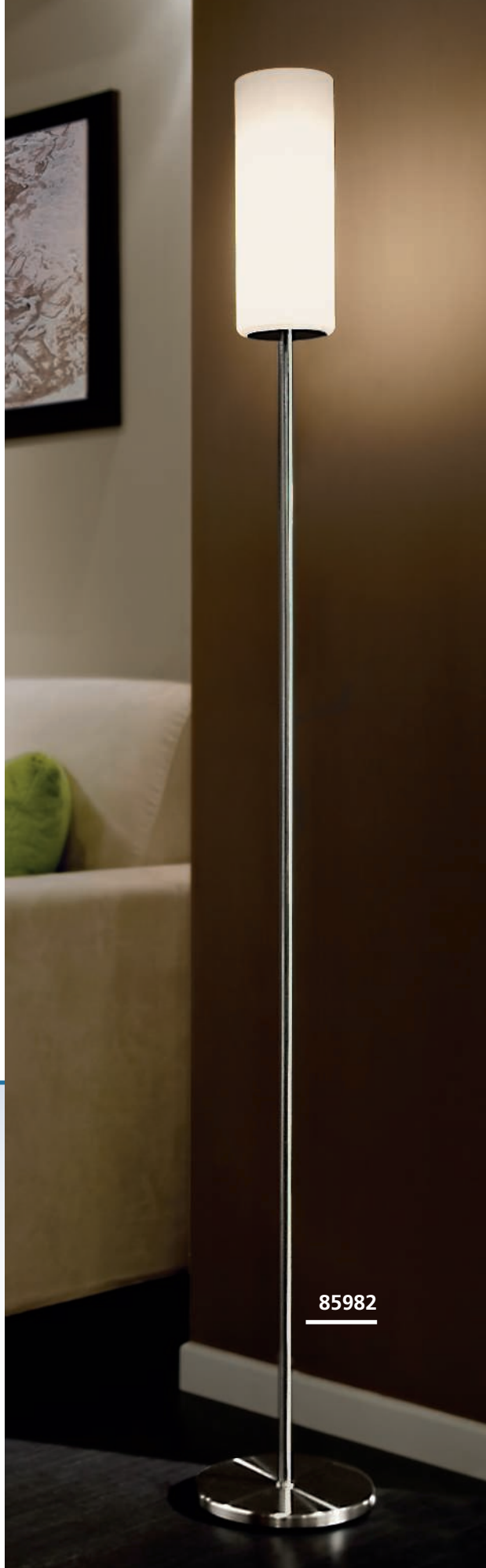

85982



92739



92739 | 92741 | 92743

92739 RIVATO

pendant light; steel, chrome / glass with decor, white, chrome
Hängeleuchte; Stahl, chrom / Glas mit Dekor, weiss, chrom
luminaire en suspension; acier, chrome / verre avec décor, blanc, chrome

H 1100, Ø 90



E27



1x 60W



9 002759 927394





92741



92742



92743



92742

92741 RIVATO

pendant light; steel, chrome / glass with decor, white, chrome
 Hängeleuchte; Stahl, chrom / Glas mit Dekor, weiss, chrom
 luminaire en suspension; acier, chrome / verre avec décor, blanc, chrome

L 705, B 90, H 1100



92742 RIVATO

wall light; steel, white, chrome / glass with decor, white, chrome
 Wandleuchte; Stahl, weiss, chrom / Glas mit Dekor, weiss, chrom
 applique; acier, blanc, chrome / verre avec décor, blanc, chrome

L 180, H 250, A 80



92743 RIVATO

table light; glass, plastic, white, chrome
 Tischleuchte; Glas, Kunststoff, weiss, chrom
 luminaire de table; verre, plastique, blanc, chrome

H 260, Ø 90

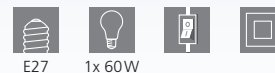



90048



90049



EGLO
RECOMMENDS
110043

90049

90048 AMADORA

pendant light; steel, satin nickel / glass printed, white
Hängeleuchte; Stahl, nickel-matt / Glas bedruckt, weiss
luminaire en suspension; acier, nickel mat / verre imprimé, blanc

L 720, B 105, H 1100



E27



3x 60W



9 002759 900489



90049 AMADORA

wall light; steel, satin nickel / glass printed, white
Wandleuchte; Stahl, nickel-matt / Glas bedruckt, weiss
applique; acier, nickel mat / verre imprimé, blanc

L 180, H 250, A 75



E14



1x 60W



9 002759 900496





92563



90048 | 91971 | 92563



91971

92563 BAYMAN

pendant light; steel, chrome / glass, white, chrome
 Hängeleuchte; Stahl, chrom / Glas, weiss, chrom
 luminaire en suspension; acier, chrome / verre, blanc, chrome

L 720, B 105, H 1100



91971 BAYMAN

table light; glass, plastic, white, chrome
 Tischleuchte; Glas, Kunststoff, weiss, chrom
 luminaire de table; verre, plastique, blanc, chrome

H 270, Ø 105

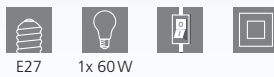



91433



91002



91004

91433 VINOVO

pendant light; steel, dark brown / glass alabaster, white
 Hängeleuchte; Stahl, dunkelbraun / Glas alabaster, weiss
 luminaire en suspension; acier, marron foncé / verre albâtre, blanc

L 770, B 250, H 1100



E27



2x 60W



9 002759 914332



L 770

91002 MURCIA

pendant light; steel, black / glass alabaster, white
 Hängeleuchte; Stahl, schwarz / Glas alabaster, weiss
 luminaire en suspension; acier, noir / verre albâtre, blanc

H 1100, Ø 380



E27



1x 60W



9 002759 910020



Ø 380

91004 MURCIA

pendant light; steel, black / glass alabaster, white
 Hängeleuchte; Stahl, schwarz / Glas alabaster, weiss
 luminaire en suspension; acier, noir / verre albâtre, blanc

L 680, H 1100



E27



2x 60W



9 002759 910044

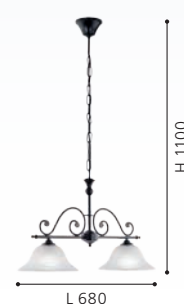

L 680



MURCIA, VINOVO

These luminaires come with high quality processed alabaster glass.

Diese Leuchten sind mit hochwertigem Alabasterglas ausgestattet.

Ces luminaires viennent avec un abat-jour en verre d'albâtre haut de gamme.

91005 MURCIA

pendant light; steel, black / glass alabaster, white
Hängeleuchte; Stahl, schwarz / Glas alabaster, weiss
luminaire en suspension; acier, noir / verre albâtre, blanc

H 1100, Ø 630

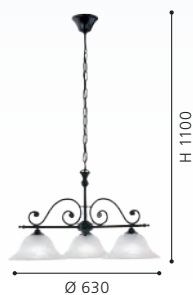

91006 MURCIA

wall light; steel, black / glass alabaster, white
Wandleuchte; Stahl, schwarz / Glas alabaster, weiss
applique; acier, noir / verre albâtre, blanc

L 165, H 190, A 230

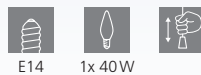



82748



82749



DESIGN
HIGHLIGHT
DETAIL

82748 SAVOY

pendant light; cast metal, bronzed / satin glass, white
Hängeleuchte; Metallguss, brüniert / Glas satiniert, weiss
luminaire en suspension; fonte métallique, brun / verre satiné, blanc

H 1100, Ø 740



E14



3x 40W



E27



2x 60W



9 002759 827489



82749 SAVOY

pendant light; cast metal, bronzed / satin glass, white
Hängeleuchte; Metallguss, brüniert / Glas satiniert, weiss
luminaire en suspension; fonte métallique, brun / verre satiné, blanc

H 1100, Ø 740



E14



6x 40W



E27



2x 60W



9 002759 827496





82751 SAVOY

wall light; cast metal, bronzed / satin glass, white
Wandleuchte; Metallguss, brüniert / Glas satiniert, weiss
applique; fonte métallique, brun / verre satiné, blanc

L 180, H 160, A 240



82752 SAVOY

wall light; cast metal, bronzed / satin glass, white
Wandleuchte; Metallguss, brüniert / Glas satiniert, weiss
applique; fonte métallique, brun / verre satiné, blanc

L 410, H 160, A 210

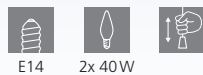

82747 SAVOY

pendant light; cast metal, bronzed / satin glass, white
Hängeleuchte; Metallguss, brüniert / Glas satiniert, weiss
luminaire en suspension; fonte métallique, brun / verre satiné, blanc

H 1100, Ø 310

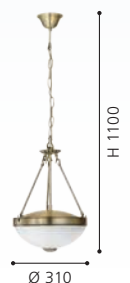



85856



85857



85859

85856 MARBELLA

ceiling light; cast metal, bronzed / glass alabaster, champagne
Deckenleuchte; Metallguss, brüniert / Glas alabaster, champagner
plafonnier; fonte métallique, brun / verre albâtre, champagne

H 410, Ø 370



E14 3x 60W



9 002759 858568

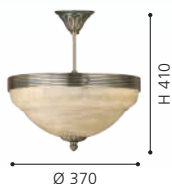

85857 MARBELLA

pendant light; cast metal, bronzed / glass alabaster, champagne
Hängeleuchte; Metallguss, brüniert / Glas alabaster, champagner
luminaire en suspension; fonte métallique, brun / verre albâtre, champagne

H 1100, Ø 740



E14 6x 60W



9 002759 858575



85859 MARBELLA

wall light; cast metal, bronzed / glass alabaster, champagne
Wandleuchte; Metallguss, brüniert / Glas alabaster, champagner
applique; fonte métallique, brun / verre albâtre, champagne

L 170, H 200, A 230



E14 1x 40W



9 002759 858599





85858

85858 MARBELLA

pendant light; cast metal, bronzed / glass alabaster, champagne
 Hängeleuchte; Metallguss, brüniert / Glas alabaster, champagner
 luminaire en suspension; fonte métallique, brun / verre albâtre, champagne

H 1100, Ø 740



E14



9x 60W



MARBELLA

These luminaires come with high quality processed alabaster glass.

Diese Leuchten sind mit hochwertigem Alabasterglas ausgestattet.

Ces luminaires viennent avec un abat-jour en verre d'albâtre haut de gamme.



98876 ERVIDEL

pendant light; steel, black / plastic, satined, clear
 Hängeleuchte; Stahl, schwarz / Kunststoff, satiniert, klar
 luminaire en suspension; acier, noir / plastique, satiné, transparent

L 930, B 60, H 1100



6x 4,5W 2880lm



9 002759 988760

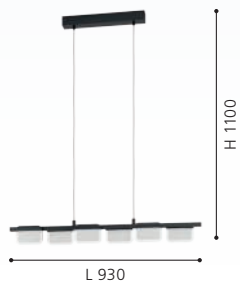

98874 ERVIDEL

ceiling light; steel, black / plastic, satined, clear
 Deckenleuchte; Stahl, schwarz / Kunststoff, satiniert, klar
 plafonnier; acier, noir / plastique, satiné, transparent

L 625, B 60, H 160



4x 4,5W 1920lm



9 002759 988746



98875 ERVIDEL

ceiling light; steel, black / plastic, satined, clear
 Deckenleuchte; Stahl, schwarz / Kunststoff, satiniert, klar
 plafonnier; acier, noir / plastique, satiné, transparent

L 930, B 60, H 160



6x 4,5W 2880lm



9 002759 988753





98878

LED



98877

LED

98878 ERVIDEL

table light; steel, black / plastic, satined, clear
Tischleuchte; Stahl, schwarz / Kunststoff, satiniert, klar
luminaire de table; acier, noir / plastique, satiné, transparent

L 155, B 60, H 500, Base: B 180, T 180



2x 4,5W 960lm



9 002759 988784



98877 ERVIDEL

wall light; steel, black / plastic, satined, clear
Wandleuchte; Stahl, schwarz / Kunststoff, satiniert, klar
applique; acier, noir / plastique, satiné, transparent

L 320, H 90, A 80



2x 4,5W 960lm



9 002759 988777





900351

LED



900352

LED



900351 CLAVELLINA

ceiling light; steel, black / plastic, white
Deckenleuchte; Stahl, schwarz / Kunststoff, weiss
plafonnier; acier, noir / plastique, blanc

L 890, B 465, H 185

LED

warm
WHITE



4x 6,8W 3200lm

900352 CLAVELLINA

pendant light; steel, black / plastic, white
Hängeleuchte; Stahl, schwarz / Kunststoff, weiss
luminaire en suspension; acier, noir / plastique, blanc

L 1200, B 400, H 1100

LED

warm
WHITE



6x 7W 4800lm

900353 CLAVELLINA

table light; steel, black / plastic, white
Tischleuchte; Stahl, schwarz / Kunststoff, weiss
luminaire de table; acier, noir / plastique, blanc

L 550, H 450, Base: Ø 180

LED

warm
WHITE



1x 6,8W 800lm



9 008606 241088



9 008606 241095

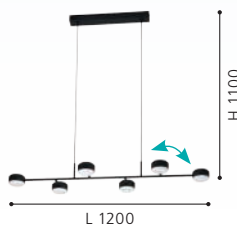

9 008606 241101

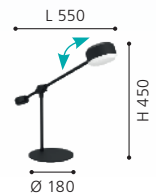



900353



900354 CLAVELLINA

floor light; steel, black / plastic, white
Stehleuchte; Stahl, schwarz / Kunststoff, weiss
lampadaire; acier, noir / plastique, blanc

L 1215, H 1605, Base: Ø 300

LED

24W

warm
WHITE

2210lm

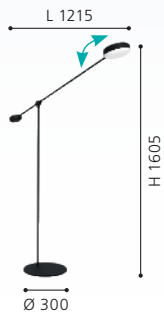

9 008606 243518

900354





99562

LED

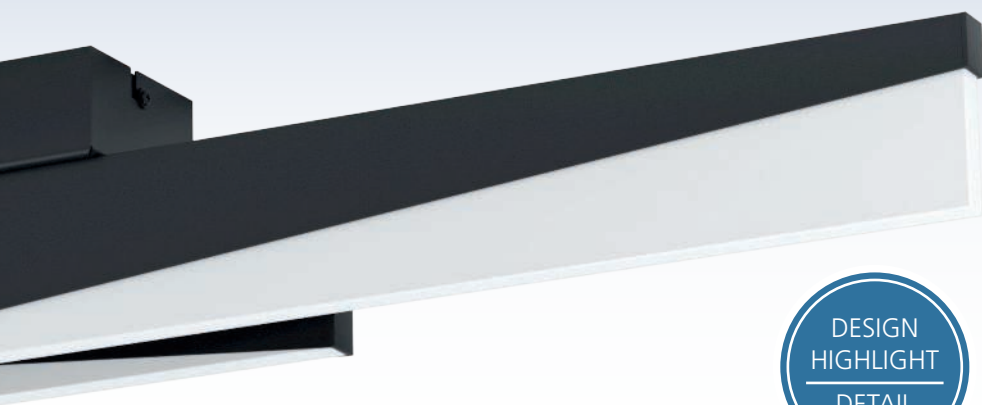

DESIGN
HIGHLIGHT
DETAIL

99562 ISIDRO

pendant light; aluminium, steel, black / plastic, satined
Hängeleuchte; Alu, Stahl, schwarz / Kunststoff, satiniert
luminaire en suspension; aluminium, acier, noir / plastique, satiné

L 795, B 60, H 1100

LED
27W

warm
WHITE
3850lm

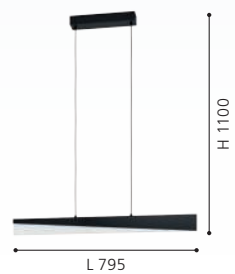



99561



99563



99564



99561 ISIDRO

ceiling light; aluminium, steel, black / plastic, satiné
Deckenleuchte; Alu, Stahl, schwarz / Kunststoff, satiniert
plafonnier; aluminium, acier, noir / plastique, satiné

L 860, B 80, H 110



2x 11W 2700lm



9 002759 995614

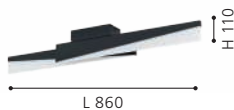

99563 ISIDRO

wall light; aluminium, steel, black / plastic, satiné
Wandleuchte; Alu, Stahl, schwarz / Kunststoff, satiniert
applique; aluminium, acier, noir / plastique, satiné

L 395, H 80, A 70



9W 1050lm



9 002759 995638



99564 ISIDRO

table light; aluminium, steel, black / plastic, satiné
Tischleuchte; Alu, Stahl, schwarz / Kunststoff, satiniert
luminaire de table; aluminium, acier, noir / plastique, satiné

L 70, B 15, H 410, Base: B 150, T 130



9W 1050lm



9 002759 995645

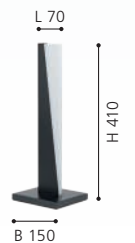



900563

LED



CARANACOA

These luminaires have swiveling light rings.

Diese Leuchten verfügen über schwenkbare Leuchtringe.

Ces luminaires ont des anneaux lumineux pivotants.

900563 CARANACOA

pendant light; steel, black / plastic, white
 Hängeleuchte; Stahl, schwarz / Kunststoff, weiss
 luminaire en suspension; acier, noir / plastique, blanc

L 1170, B 230, H 1100

LED

5x 7W

warm
 WHITE

7000lm

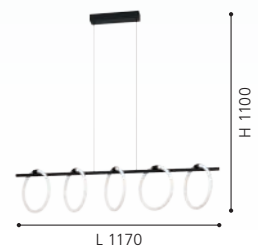



900562

LED



900564

LED



900565

LED

900562 CARANACOA

pendant light; steel, black / plastic, white
Hängeleuchte; Stahl, schwarz / Kunststoff, weiss
luminaire en suspension; acier, noir / plastique, blanc

L 780, B 230, H 1100



3x 9W 3600lm



9 008606 244645

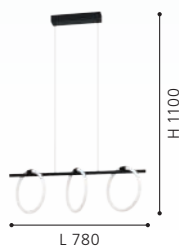

900564 CARANACOA

wall light; steel, black / plastic, white
Wandleuchte; Stahl, schwarz / Kunststoff, weiss
applique; acier, noir / plastique, blanc

L 260, H 260, A 45



11,5W 1500lm



9 008606 244669



900565 CARANACOA

table light; steel, black / plastic, white
Tischleuchte; Stahl, schwarz / Kunststoff, weiss
luminaire de table; acier, noir / plastique, blanc

L 260, B 50, H 260, Base: Ø 100



11,5W 1500lm



9 008606 244676





39836

LED



99429

LED

39836 BANDERILLAS

ceiling light; steel, black / plastic, white, black
 Deckenleuchte; Stahl, schwarz / Kunststoff, weiss, schwarz
 plafonnier; acier, noir / plastique, blanc, noir

L 1160, B 170, H 200



2x 12W
 2x
 1950lm



9 002759 398361

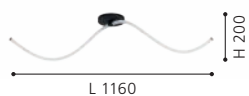

99429 ALAMEDILLA

pendant light; steel, black / plastic, white, black
 Hängeleuchte; Stahl, schwarz / Kunststoff, weiss, schwarz
 luminaire en suspension; acier, noir / plastique, blanc, noir

L 970, B 380, H 1200



27W
 4200lm



9 002759 994297



39838 BANDERILLAS

table light; plastic, black / plastic, white
 Tischleuchte; Kunststoff, schwarz / Kunststoff, weiss
 luminaire de table; plastique, noir / plastique, blanc

H 300, Ø 195



10W
 1300lm



9 002759 398385





39838

LED

39839 BANDERILLAS

pendant light; steel, black / plastic, white, black
 Hängeleuchte; Stahl, schwarz / Kunststoff, weiss, schwarz
 luminaire en suspension; acier, noir / plastique, blanc, noir

H 1200, Ø 600



9 002759 398392

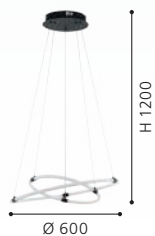

39839

LED



99358



900631



900632



99358 CODRIALES

pendant light; steel, black / plastic, white
Hängeleuchte; Stahl, schwarz / Kunststoff, weiss
luminaire en suspension; acier, noir / plastique, blanc

L 780, B 300, H 1100



27W



4000lm



9 002759 993580



900631 CODRIALES

ceiling light; aluminium, black / plastic, white
Deckenleuchte; Alu, schwarz / Kunststoff, weiss
plafonnier; aluminium, noir / plastique, blanc

L 790, B 300, H 116



27W



4000lm



9 008606 241040



900632 CODRIALES

wall light; aluminium, black / plastic, white
Wandleuchte; Alu, schwarz / Kunststoff, weiss
applique; aluminium, noir / plastique, blanc

L 180, H 320, A 65



10,8W



1400lm



9 008606 241057





900633



900633 CODRIALES

table light; aluminium, black / plastic, white

Tischleuchte; Alu, schwarz / Kunststoff, weiss

luminaire de table; aluminium, noir / plastique, blanc

L 205, B 80, H 380



10,8W



1500lm



9 008606 241064

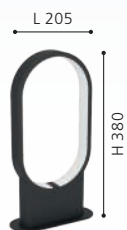



900465 SIBERIA

ceiling light; steel, black / plastic, white
 Deckenleuchte; Stahl, schwarz / Kunststoff, weiss
 plafonnier; acier, noir / plastique, blanc

L 780, B 160, H 235



34W 4600lm



9 008606 244041



900466 SIBERIA

pendant light; steel, black / plastic, white
 Hängeleuchte; Stahl, schwarz / Kunststoff, weiss
 luminaire en suspension; acier, noir / plastique, blanc

L 780, B 160, H 1100



34W 4500lm



9 008606 244058

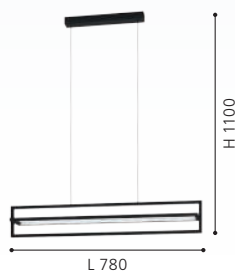

900467 SIBERIA

wall light; steel, black / plastic, white
 Wandleuchte; Stahl, schwarz / Kunststoff, weiss
 applique; acier, noir / plastique, blanc

L 160, H 300, A 190



15,5W 2200lm



9 008606 244065





900468

LED

incl./inkl./inclus



900469

LED

900468 SIBERIA

table light; steel, black / plastic, white
Tischleuchte; Stahl, schwarz / Kunststoff, weiss
luminaire de table; acier, noir / plastique, blanc

L 160, B 160, H 430, Base: B 160, T 160



15,5W 2200lm



9 008606 244072

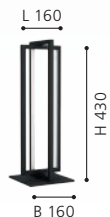

900469 SIBERIA

floor light; steel, black / plastic, white
Stehleuchte; Stahl, schwarz / Kunststoff, weiss
lampadaire; acier, noir / plastique, blanc

L 200, B 160, H 1330, Base: B 200, T 160



34W 4600lm



9 008606 244089

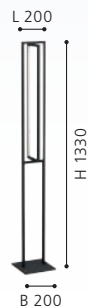



99799



99801



99802



99799 LEJIAS

ceiling light; steel, black / plastic, transparent
 Deckenleuchte; Stahl, schwarz / Kunststoff, transparent
 plafonnier; acier, noir / plastique, transparent

L 450, B 450, H 75



21W 3050lm



9 002759 997991

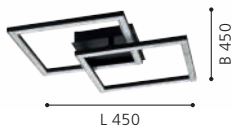

99801 LEJIAS

ceiling light; steel, black / plastic, transparent
 Deckenleuchte; Stahl, schwarz / Kunststoff, transparent
 plafonnier; acier, noir / plastique, transparent

L 780, B 80



21,5W 2600lm



9 002759 998011



99802 LEJIAS

pendant light; steel, black / plastic, transparent
 Hängeleuchte; Stahl, schwarz / Kunststoff, transparent
 luminaire en suspension; acier, noir / plastique, transparent

L 780, B 80, H 1750



21,5W 2600lm



9 002759 998028

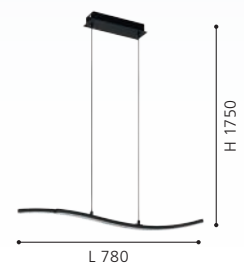



99803

LED



99804

LED



99805

LED

99803 LEJIAS

wall light; steel, black / plastic, transparent
Wandleuchte; Stahl, schwarz / Kunststoff, transparent
applique; acier, noir / plastique, transparent

L 90, H 285



8W 1050lm



9 002759 998035



99804 LEJIAS

table light; steel, black / plastic, transparent
Tischleuchte; Stahl, schwarz / Kunststoff, transparent
luminaire de table; acier, noir / plastique, transparent

H 330, Base: B 140, T 140



8W 900lm



9 002759 998042



99805 LEJIAS

floor light; steel, black / plastic, transparent
Stehleuchte; Stahl, schwarz / Kunststoff, transparent
lampadaire; acier, noir / plastique, transparent

H 1230, Base: B 230, T 230



16W 2050lm



9 002759 998059



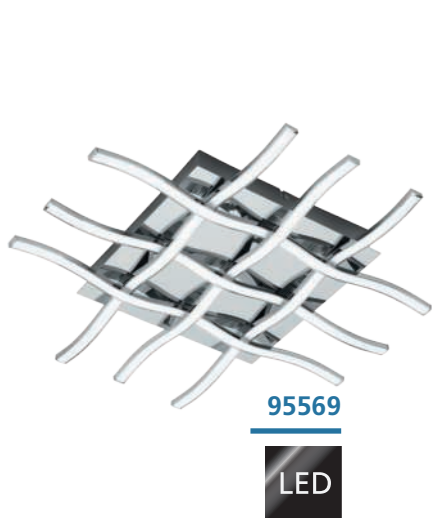

95569

LED

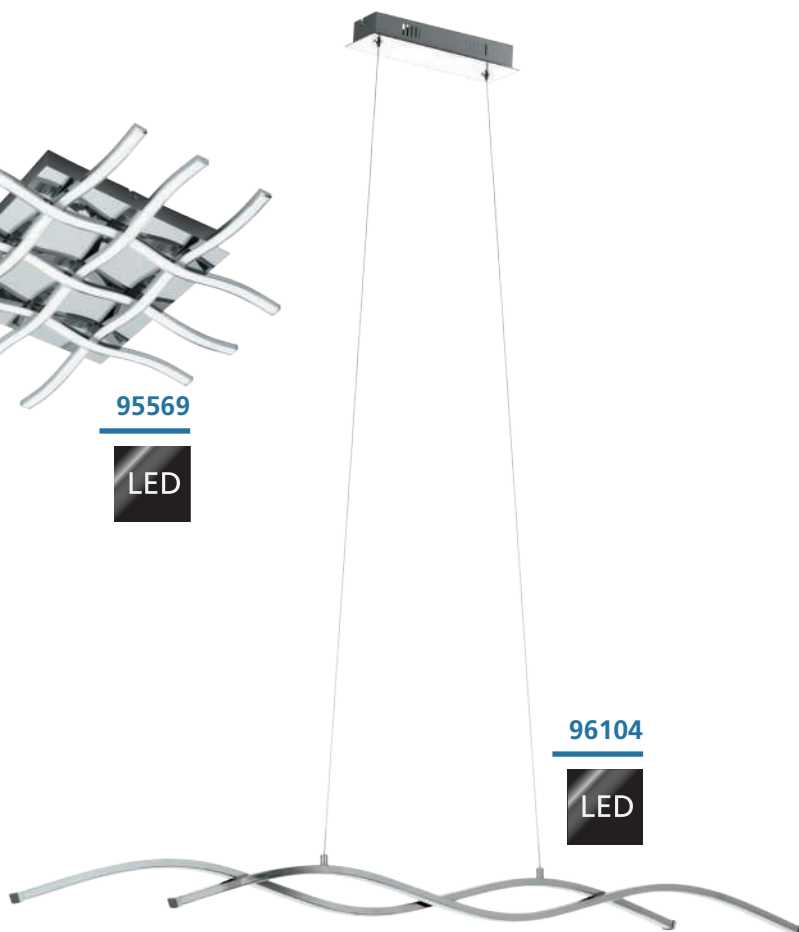

96104

LED

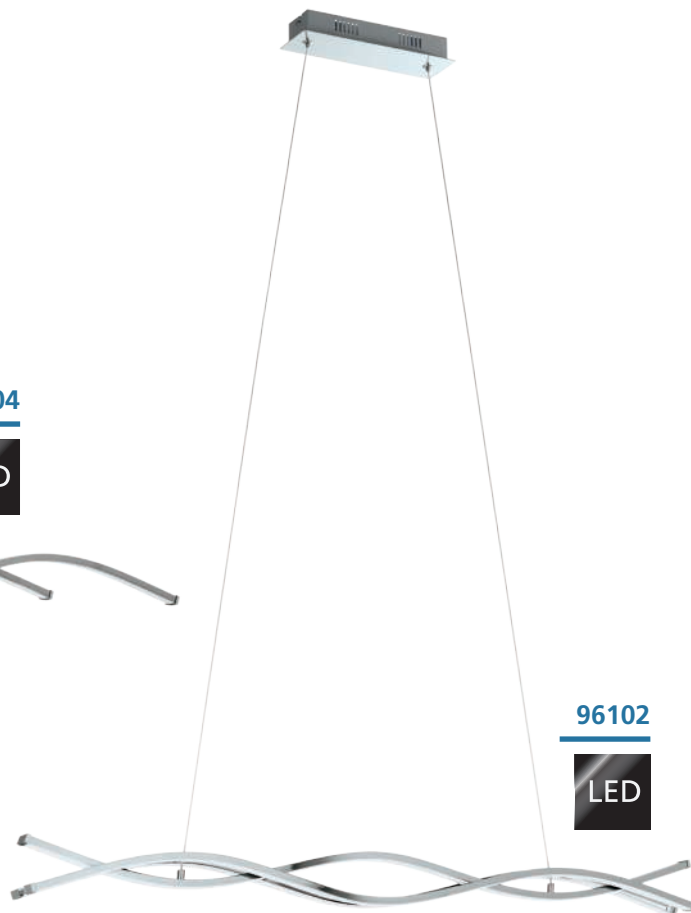

96102

LED

95569 LASANA 1

wall / ceiling light; steel, chrome / plastic, white
Wand- / Deckenleuchte; Stahl, chrom / Kunststoff, weiss
applique / plafonnier; acier, chrome / plastique, blanc

L 500, B 500, H 65

LED

warm
WHITE



6x 6W 4860lm



9 002759 955694

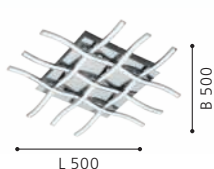

96104 LASANA 2

pendant light; steel, aluminium, chrome / plastic, white
Hängeleuchte; Stahl, Alu, chrom / Kunststoff, weiss
luminaire en suspension; acier, aluminium, chrome / plastique, blanc

L 1200, B 80, H 1200

LED

warm
WHITE



24,5W 3300lm



9 002759 961046

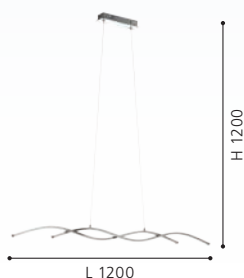

96102 LASANA 2

pendant light; steel, aluminium, chrome / plastic, white
Hängeleuchte; Stahl, Alu, chrom / Kunststoff, weiss
luminaire en suspension; acier, aluminium, chrome / plastique, blanc

L 1000, B 80, H 1200

LED

warm
WHITE



35W 5300lm



9 002759 961022



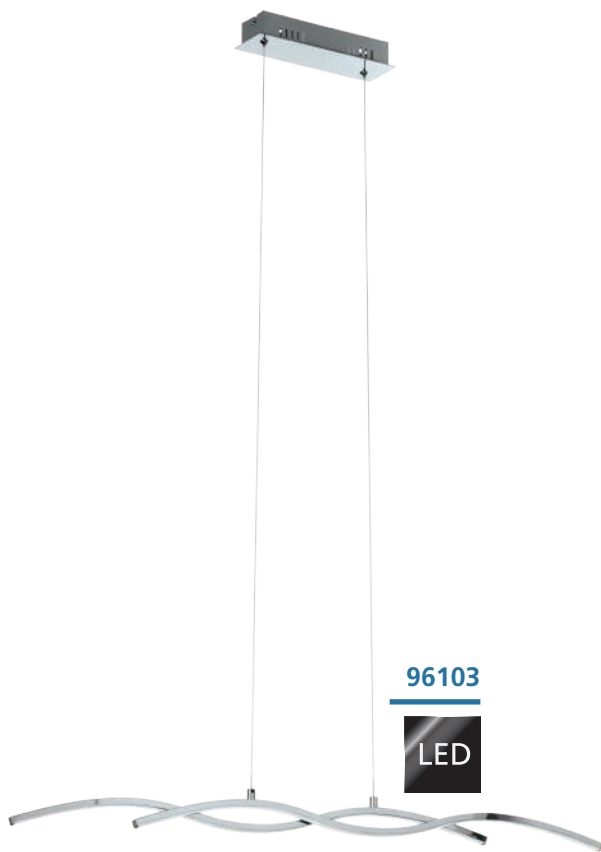

96103

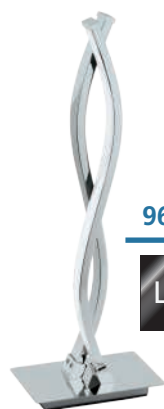

96105



96106



96103 LASANA 2

pendant light; steel, aluminium, chrome / plastic, white
 Hängeleuchte; Stahl, Alu, chrom / Kunststoff, weiss
 luminaire en suspension; acier, aluminium, chrome / plastique, blanc

L 870, B 80, H 1200



18W 2300lm



9 002759 961039

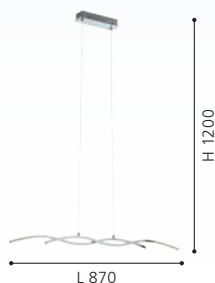

96105 LASANA 2

table light; steel, aluminium, chrome / plastic, white
 Tischleuchte; Stahl, Alu, chrom / Kunststoff, weiss
 luminaire de table; acier, aluminium, chrome / plastique, blanc

L 160, B 100, H 460



11,5W 1280lm



9 002759 961053



96106 LASANA 2

floor light; steel, aluminium, chrome / plastic, white
 Stehleuchte; Stahl, Alu, chrom / Kunststoff, weiss
 lampadaire; acier, aluminium, chrome / plastique, blanc

L 250, B 130, H 1420



36W 4700lm



9 002759 961060



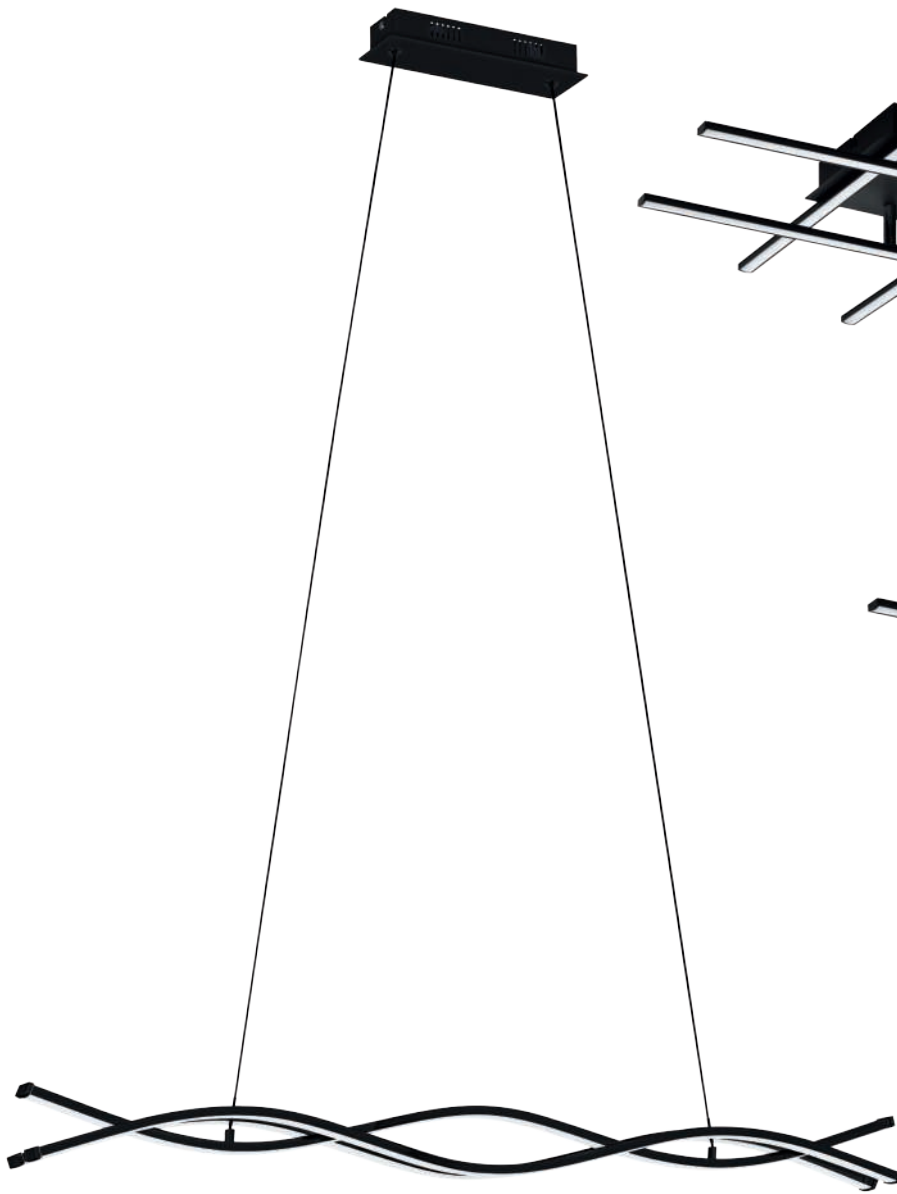

99317

LED

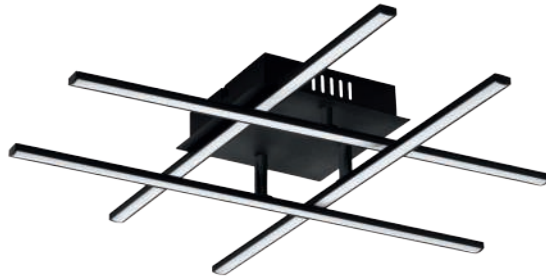

99316

LED



99315

LED

99317 LASANA 3

pendant light; steel, aluminium, black / plastic, white
Hängeleuchte; Stahl, Alu, schwarz / Kunststoff, weiss
luminaire en suspension; acier, aluminium, noir / plastique, blanc

L 985, B 80, H 1200



33W 4500lm



9 002759 993177

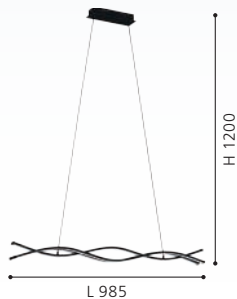

99316 LASANA 3

wall / ceiling light; steel, aluminium, black / plastic, white
Wand- / Deckenleuchte; Stahl, Alu, schwarz / Kunststoff, weiss
applique / plafonnier; acier, aluminium, noir / plastique, blanc

L 500, B 500, H 95



4x 5,3W 2800lm



9 002759 993160

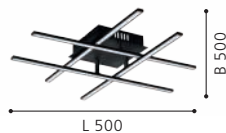

99315 LASANA 3

wall / ceiling light; steel, aluminium, black / plastic, white
Wand- / Deckenleuchte; Stahl, Alu, schwarz / Kunststoff, weiss
applique / plafonnier; acier, aluminium, noir / plastique, blanc

L 500, B 145, H 90



3x 3,5W 1500lm



9 002759 993153

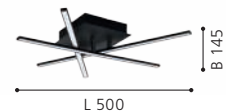



99319

LED



99318

LED

99319 LASANA 3

floor light; steel, aluminium, black / plastic, white
 Stehleuchte; Stahl, Alu, schwarz / Kunststoff, weiss
 lampadaire; acier, aluminium, noir / plastique, blanc

L 250, B 130, H 1420, Base: B 230, T 150



36W 4700lm



9 002759 993191



99318 LASANA 3

table light; steel, aluminium, black / plastic, white
 Tischleuchte; Stahl, Alu, schwarz / Kunststoff, weiss
 luminaire de table; acier, aluminium, noir / plastique, blanc

L 160, B 100, H 460, Base: B 180, T 100



11,5W 1280lm



9 002759 993184





95147

LED



32048

LED

95147 LASANA

pendant light; aluminium, steel, chrome / plastic, white
 Hängeleuchte; Alu, Stahl, chrom / Kunststoff, weiss
 luminaire en suspension; aluminium, acier, chrome / plastique, blanc

L 900, H 1100

LED

30W

warm
WHITE

3500lm



9 002759 951474

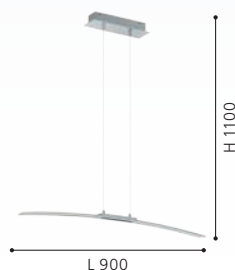

32048 LASANA

pendant light; aluminium, steel, chrome / plastic, white
 Hängeleuchte; Alu, Stahl, chrom / Kunststoff, weiss
 luminaire en suspension; aluminium, acier, chrome / plastique, blanc

L 900, H 1000

LED

15W

warm
WHITE

1800lm



9 002759 320485

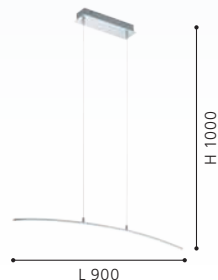

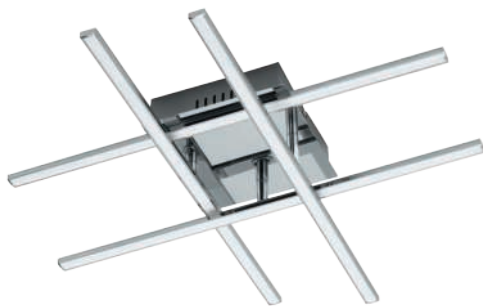

95568

LED



95567

LED



96866

LED

95568 LASANA 1

wall / ceiling light; steel, chrome / plastic, white
Wand- / Deckenleuchte; Stahl, chrom / Kunststoff, weiss
applique / plafonnier; acier, chrome / plastique, blanc

L 500, B 500, H 95



4x 5,3W 2800lm



9 002759 955687

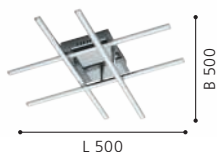

95567 LASANA 1

wall / ceiling light; steel, chrome / plastic, white
Wand- / Deckenleuchte; Stahl, chrom / Kunststoff, weiss
applique / plafonnier; acier, chrome / plastique, blanc

L 500, B 160, H 95



3x 3,5W 1500lm



9 002759 955670

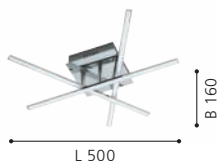

96866 TARANDELL

pendant light; aluminium, steel, chrome / plastic, satiné
Hängeleuchte; Alu, Stahl, chrom / Kunststoff, satiniert
luminaire en suspension; aluminium, acier, chrome / plastique, satiné

L 1180, B 60, H 930 - 1620



2x 12,5W 3300lm



9 002759 968663

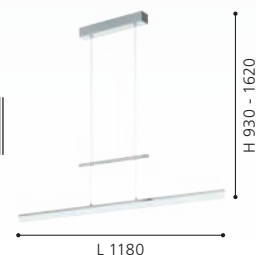



99322

LED



99321

LED



99323

LED

99322 RONCADE 1

wall / ceiling light; steel, aluminium, black / plastic, white
Wand- / Deckenleuchte; Stahl, Alu, schwarz / Kunststoff, weiss
applique / plafonnier; acier, aluminium, noir / plastique, blanc

L 1160, B 180, H 115



36W 4600lm

99321 RONCADE 1

wall / ceiling light; steel, aluminium, black / plastic, white
Wand- / Deckenleuchte; Stahl, Alu, schwarz / Kunststoff, weiss
applique / plafonnier; acier, aluminium, noir / plastique, blanc

L 650, B 130, H 45



21W 2800lm

99323 SELVINA 1

ceiling light; steel, aluminium, black / plastic, white
Deckenleuchte; Stahl, Alu, schwarz / Kunststoff, weiss
plafonnier; acier, aluminium, noir / plastique, blanc

L 690, B 280, H 150



19W 2700lm



9 002759 993221

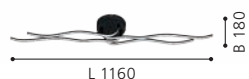

9 002759 993214

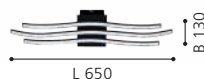

9 002759 993238





31996



31995



96329



31996 RONCADE

wall / ceiling light; aluminium, steel, chrome / plastic, white
Wand- / Deckenleuchte; Alu, Stahl, chrom / Kunststoff, weiss
applique / plafonnier; aluminium, acier, chrome / plastique, blanc

L 1085, B 160, H 125



32W 4500lm

31995 RONCADE

wall / ceiling light; aluminium, steel, chrome / plastic, white
Wand- / Deckenleuchte; Alu, Stahl, chrom / Kunststoff, weiss
applique / plafonnier; aluminium, acier, chrome / plastique, blanc

L 650, B 130, H 45



21W 2800lm

96329 SELVINA

ceiling light; aluminium, chrome / plastic, white
Deckenleuchte; Alu, chrom / Kunststoff, weiss
plafonnier; aluminium, chrome / plastique, blanc

L 700, B 420, H 150



19W 2700lm



9 002759 319960

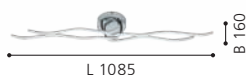

9 002759 319953

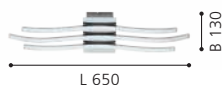

9 002759 963293





96308

LED



96327

LED



96326

LED

96308 SELVINA

ceiling light; aluminium, chrome / plastic, white
Deckenleuchte; Alu, chrom / Kunststoff, weiss
plafonnier; aluminium, chrome / plastique, blanc

L 745, B 175, H 85

LED

warm
WHITE
2900lm



96327 VALMORA

ceiling light; aluminium, chrome / plastic, white
Deckenleuchte; Alu, chrom / Kunststoff, weiss
plafonnier; aluminium, chrome / plastique, blanc

L 560, B 560, H 105

LED

warm
WHITE
2450lm



96326 VALMORA

ceiling light; aluminium, chrome / plastic, white
Deckenleuchte; Alu, chrom / Kunststoff, weiss
plafonnier; aluminium, chrome / plastique, blanc

L 590, B 125, H 90

LED

warm
WHITE
1700lm



9 002759 963088



9 002759 963279

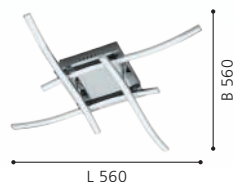

9 002759 963262

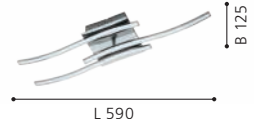



96332

LED



96305

LED

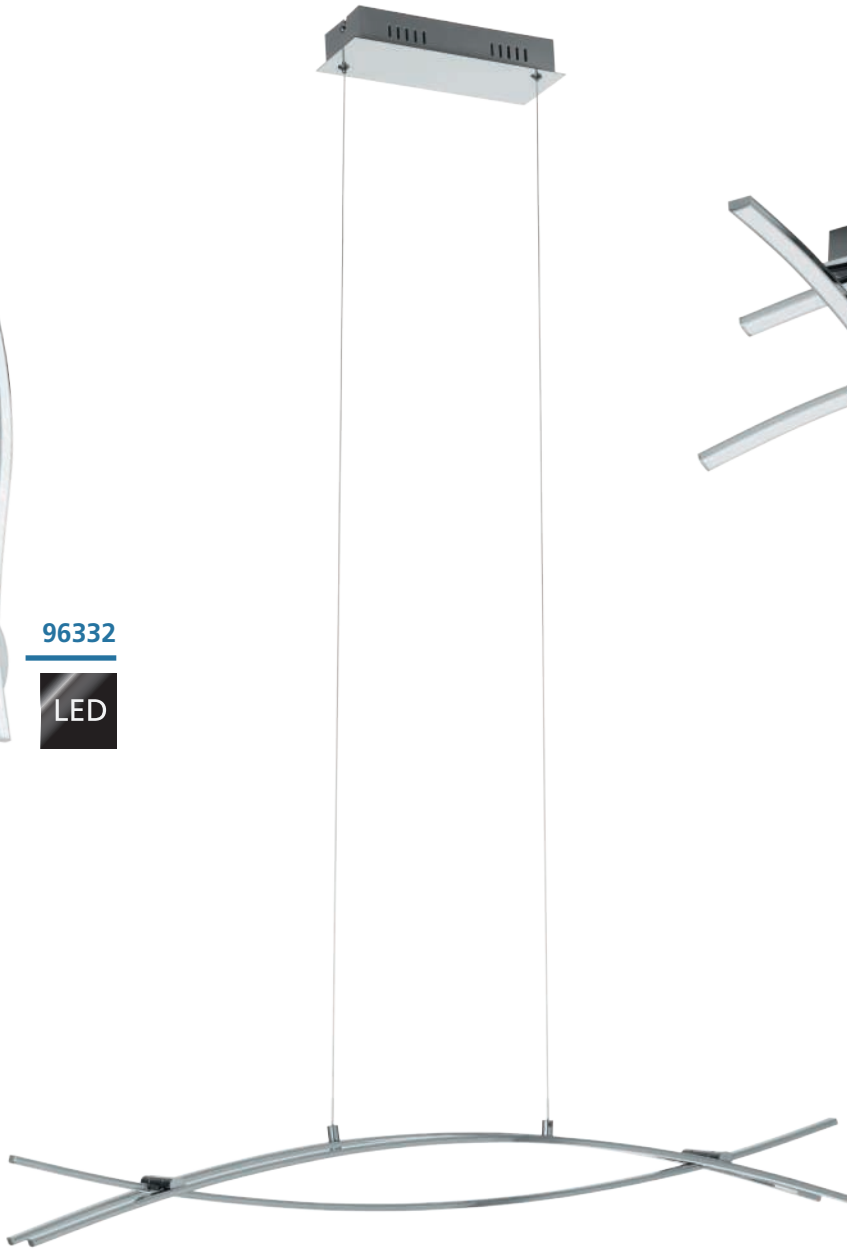

96331

LED

96332 VALMORA

wall light; aluminium, chrome / plastic, white
Wandleuchte; Alu, chrom / Kunststoff, weiss
applique; aluminium, chrome / plastique, blanc

L 115, H 450, A 90

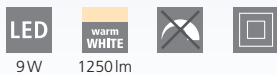

9W 1250lm



9 002759 963323



96331 NEVADO

pendant light; aluminium, chrome / plastic, white
Hängeleuchte; Alu, chrom / Kunststoff, weiss
luminaire en suspension; aluminium, chrome / plastique, blanc

L 900, B 80, H 1100



23,6W 3400lm



9 002759 963316

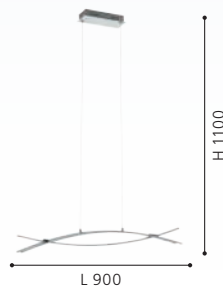

96305 NEVADO

ceiling light; aluminium, chrome / plastic, white
Deckenleuchte; Alu, chrom / Kunststoff, weiss
plafonnier; aluminium, chrome / plastique, blanc

L 500, B 500, H 115



18W 2450lm



9 002759 963057

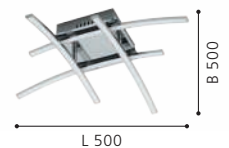



96306

LED



98889

LED



99559

LED

96306 SELVINA

ceiling light; aluminium, chrome / plastic, white
Deckenleuchte; Alu, chrom / Kunststoff, weiss
plafonnier; aluminium, chrome / plastique, blanc

L 460, B 390, H 380



28W

3600lm

98889 PALOZZA 1

wall light; aluminium, satin nickel / plastic, white
Wandleuchte; Alu, nickel-matt / Kunststoff, weiss
applique; aluminium, nickel mat / plastique, blanc

L 170, H 425, A 60



10W

1300lm

99559 PALOZZA 1

table light; aluminium, satin nickel / plastic, white
Tischleuchte; Alu, nickel-matt / Kunststoff, weiss
luminaire de table; aluminium, nickel mat / plastique, blanc

L 150, B 110, H 420



11W

1400lm



9 002759 963064

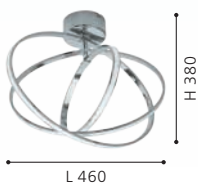

9 002759 988890



9 002759 995591



31997 RONCADE

table light; aluminium, steel, chrome / plastic, white
Tischleuchte; Alu, Stahl, chrom / Kunststoff, weiss
luminaire de table; aluminium, acier, chrome / plastique, blanc

L 195, B 150, H 335

LED

8,8W

warm
WHITE

866lm



9 002759 319977



31997

LED



97362



97361



97363



97362 PALOZZA

pendant light; aluminium, rose gold / plastic, white
 Hängeleuchte; Alu, roségold / Kunststoff, weiss
 luminaire en suspension; aluminium, rose or / plastique, blanc

L 705, B 315, H 1100



19W 2600lm



9 002759 973629



97361 PALOZZA

ceiling light; aluminium, rose gold / plastic, white
 Deckenleuchte; Alu, roségold / Kunststoff, weiss
 plafonnier; aluminium, rose or / plastique, blanc

L 705, B 315, H 125



19W 2700lm



9 002759 973612

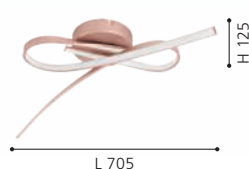

97363 PALOZZA

wall light; aluminium, rose gold / plastic, white
 Wandleuchte; Alu, roségold / Kunststoff, weiss
 applique; aluminium, rose or / plastique, blanc

L 170, H 425, A 60



9W 1400lm



9 002759 973636





97364

LED

97364 PALOZZA

table light; aluminium, rose gold / plastic, white
Tischleuchte; Alu, roségold / Kunststoff, weiss
luminaire de table; aluminium, rose or / plastique, blanc

H 380, Ø 185, Base: Ø 150

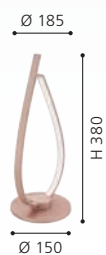

LIGHTING FAMILIES

GLASS CHANDELIERS
GLASLUSTER
LUSTRES EN VERRE

SPARKLING

Extravagant lighting – our glass chandeliers will give you light in a new diversity while ensuring an extraordinary ambience. Our chandeliers are true jewels on your ceiling and spread their elegance in your entire living area.

FUNKELN

Beleuchtung der Extravaganz – Mit unseren Glaslustern erleben Sie Licht in neuer Vielfalt und sorgen für ein außergewöhnliches Ambiente. Unsere Kronleuchter werden zum wahren Schmuckstück und bringen Eleganz in all Ihre Wohnbereiche.

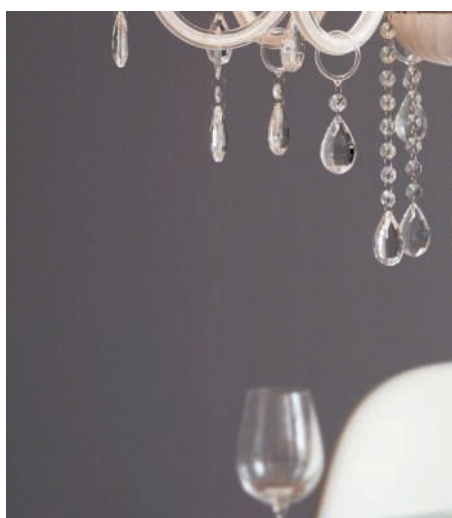

DU SCINTILLEMENT

Un éclairage riche en extravagance – Avec nos lustres en verre, vous faites l'expérience de la lumière dans une nouvelle multiplicité et vous assurez une ambiance extraordinaire. Nos plafonniers lustres en deviennent de vrais bijoux et prêtent de l'élégance à tous vos espaces d'habitat.



OVERVIEW

LIGHTING FAMILIES / GLASS CHANDELIERS



BASILANO 1
p. 320-321



BASILANO
p. 322-323



CARPENTIO
p. 324



This product is available in different colors and shapes./ Dieser Artikel ist in unterschiedlichen Farben und Formen verfügbar.
Cet article est disponible en différentes couleurs et formes.





39103



39101

39103 BASILANO 1

pendant light; steel, chrome / glass, clear
 Hängeleuchte; Stahl, chrom / Glas, klar
 luminaire en suspension; acier, chrome / verre, transparent

H 1500, Ø 1000



E14 18x40W



9 002759 391034

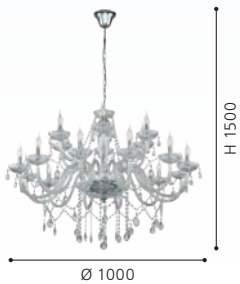

H 1500

Ø 1000

39101 BASILANO 1

pendant light; steel, chrome / glass, clear
 Hängeleuchte; Stahl, chrom / Glas, klar
 luminaire en suspension; acier, chrome / verre, transparent

H 1300, Ø 820



E14 8x40W



9 002759 391010



H 1300

Ø 820

39099 BASILANO 1

pendant light; steel, chrome / glass, clear
 Hängeleuchte; Stahl, chrom / Glas, klar
 luminaire en suspension; acier, chrome / verre, transparent

H 1300, Ø 720



E14 6x40W



9 002759 390990



H 1300

Ø 720



39099



39102

39102 BASILANO 1

pendant light; steel, chrome / glass, clear

Hängeleuchte; Stahl, chrom / Glas, klar

luminaire en suspension; acier, chrome / verre, transparent

H 1500, Ø 1000



E14



12x 40W



9 002759 391027



H 1500

Ø 1000



39095



39092

39095 BASILANO

pendant light; steel, chrome / glass, cognac
 Hängeleuchte; Stahl, chrom / Glas, cognac
 luminaire en suspension; acier, chrome / verre, cognac

H 1500, Ø 1000



E14 18x 40W



9 002759 390952



39092 BASILANO

pendant light; steel, chrome / glass, cognac
 Hängeleuchte; Stahl, chrom / Glas, cognac
 luminaire en suspension; acier, chrome / verre, cognac

H 1300, Ø 720



E14 6x 40W



9 002759 390921





39093



39094

39093 BASILANO

pendant light; steel, chrome / glass, cognac
 Hängeleuchte; Stahl, chrom / Glas, cognac
 luminaire en suspension; acier, chrome / verre, cognac

H 1300, Ø 820



E14 8x 40W



39094 BASILANO

pendant light; steel, chrome / glass, cognac
 Hängeleuchte; Stahl, chrom / Glas, cognac
 luminaire en suspension; acier, chrome / verre, cognac

H 1500, Ø 1000

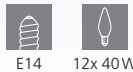

E14 12x 40W





39113

39113 CARPENTO

pendant light; steel, chrome / glass, white
 Hängeleuchte; Stahl, chrom / Glas, weiss
 luminaire en suspension; acier, chrome / verre, blanc

H 1200, Ø 590



E14

5x 40W



9 002759 391133



39114 CARPENTO

pendant light; steel, chrome / glass, white
 Hängeleuchte; Stahl, chrom / Glas, weiss
 luminaire en suspension; acier, chrome / verre, blanc

H 1300, Ø 700



E14

8x 40W



9 002759 391140





39114



HANGING & PENDANT LUMINAIRES

HÄNGE- & PENDELLEUCHTEN
LUMINAIRES SUSPENSIONS

SUSPENDED LIGHTING

Our wide variety of suspended and pendant luminaires contain classical as well as extravagant designs and supply any furnishing style. Set beautiful accents with your favourites and give your home a special atmosphere.

BELEUCHTUNG ZUM ABHÄNGEN

Unser breitgefächertes Hänge- und Pendelleuchten-Sortiment beinhaltet sowohl klassische als auch extravagante Designs und bedient jeden Einrichtungsstil. Setzen Sie mit Ihren Favoriten schöne Akzente und verleihen Sie Ihrem Zuhause eine besondere Atmosphäre.



























































ÉCLAIRAGES SUSPENDUS

Notre large gamme d'éclairages suspendus et pendulaires comprend aussi bien des designs classiques qu'extravagants et est adaptée à tout style d'ameublement. Mettez avec vos favoris de beaux accents et donnez une atmosphère particulière à votre intérieur.



OVERVIEW

HANGING & PENDANT LUMINAIRES

 OILELLA p. 330-331	 AGUILARES p. 332	 LEBALIO p. 333	 MARYVILLA p. 334	 ALOBRASE p. 335-339	 BATISTA p. 335	 CADAQUES p. 340	 CADAQUES 1 p. 340
 TORRONTES p. 340	 ARISCANI p. 342-343	 MURMILLO p. 344	 FARSALA p. 345	 BELESER p. 346-766	 MANTUNALLE 1 p. 347	 MANTUNALLE p. 348	 SELVINO p. 350-351
 ALBARACCIN p. 352-353	 LAGUNITAS p. 354	 CERASELLA p. 355	 ROCAMAR p. 356, 358	 ROCAMAR 1 p. 357-358	 CORETTO p. 357	 LONCINO 1 p. 359	 ALEANDRO 1 p. 360
 ROMAGNESE p. 360	 VALLASPRA p. 361	 BATISTA 3 p. 361	 BOLSANO p. 362	 CLEMENTE p. 363	 CARDITO 1 p. 364	 FEDRA 2 p. 365	 VARRAZO p. 365
 LUBERIO p. 366	 MONTEFIO 1 p. 366-367	 MIOGLIA 1 p. 368	 CONESSA p. 368-369	 ENALURI p. 370	 CARTAMA p. 371	 MONTEFINO p. 372	 CORTENOVA p. 374
 POZUETA p. 377	 BOCADELLA p. 378	 MEZZANA p. 378	 GRADOLI p. 380	 GRADOLI 1 p. 381	 MANIZALES p. 381	 CUMIOLE p. 382	 MONTEBALDO p. 383
 BITACHITO p. 383	 CORTADERAS p. 384	 SARONA p. 386	 LOBATIA p. 387	 SILVARES p. 388	 TAREGA p. 389	 GATUELA 1 p. 390	 GATUELA p. 391

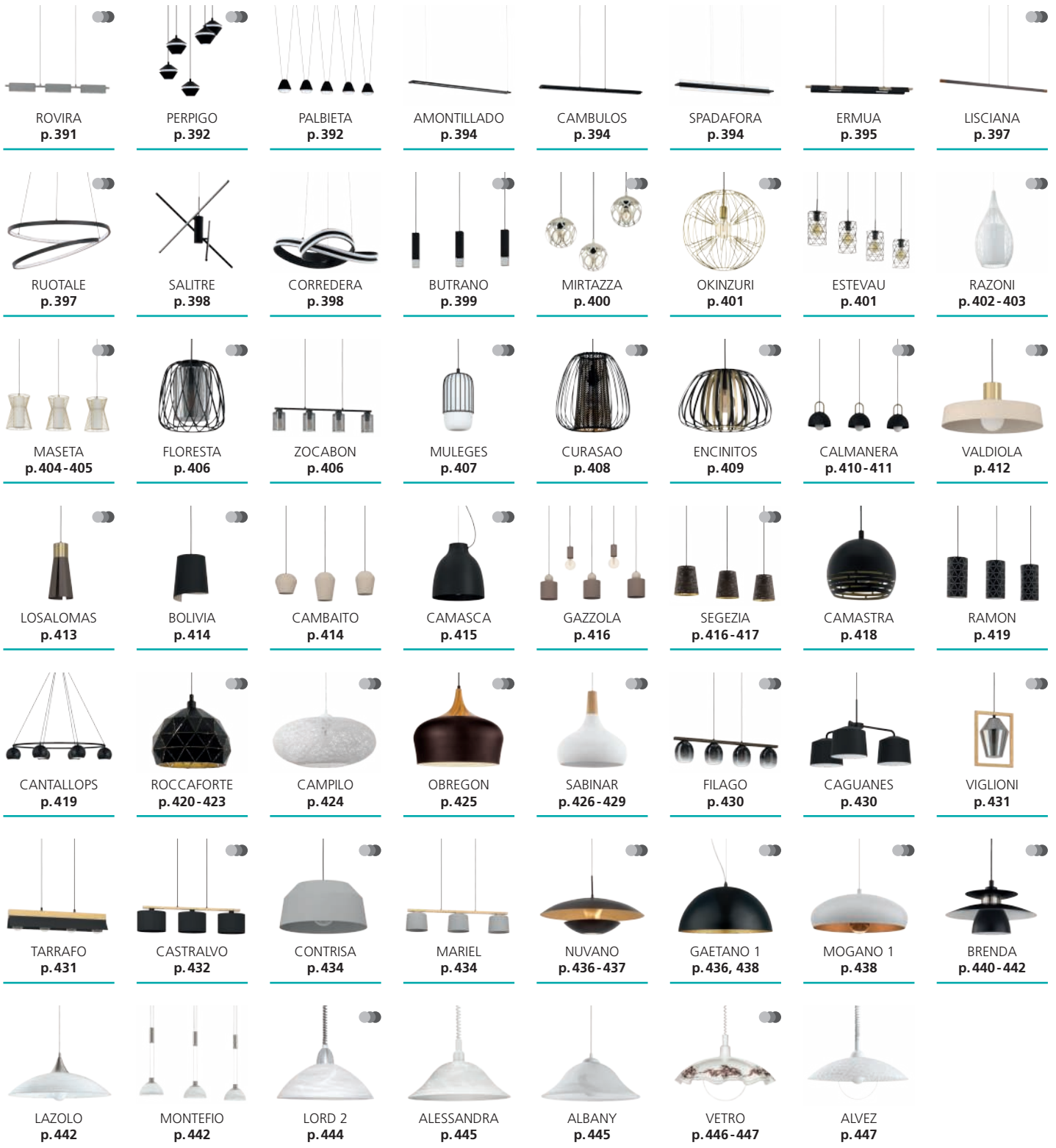

 This product is available in different colors and shapes./ Dieser Artikel ist in unterschiedlichen Farben und Formen verfügbar.
Cet article est disponible en différentes couleurs et formes.



99614 OILELLA

pendant light; steel, black, brass / glass vaporized, black-brown-transparent

Hängeleuchte; Stahl, schwarz, messing / Glas bedampft, schwarz-braun-transparent

luminaire en suspension; acier, noir, laiton / verre vaporisé, noir-marron-transparent

H 1100, Ø 190



E27

1x 40W



9 002759 996147



99615 OILELLA

pendant light; steel, black, brass / glass vaporized, black-brown-transparent

Hängeleuchte; Stahl, schwarz, messing / Glas bedampft, schwarz-braun-transparent

luminaire en suspension; acier, noir, laiton / verre vaporisé, noir-marron-transparent

L 950, B 190, H 1100



E27

3x 40W



9 002759 996154



99616 OILELLA

pendant light; steel, black, brass / glass vaporized, black-grey-transparent

Hängeleuchte; Stahl, schwarz, messing / Glas bedampft, schwarz-grau-transparent

luminaire en suspension; acier, noir, laiton / verre vaporisé, noir-gris-transparent

H 1100, Ø 190



E27

1x 40W



9 002759 996161

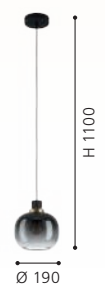



99617



99617 OILELLA

pendant light; steel, black, brass / glass vaporized,
black-grey-transparent

Hängeleuchte; Stahl, schwarz, messing / Glas bedampft,
schwarz-grau-transparent

luminaire en suspension; acier, noir, laiton / verre vaporisé,
noir-gris-transparent

L 950, B 190, H 1100



E27



3x 40W





900195



900196



900195 AGUILARES

pendant light; steel, black / glass vaporized, black-grey-transparent

Hängeleuchte; Stahl, schwarz / Glas bedampft, schwarz-grau-transparent

luminaire en suspension; acier, noir / verre vaporisé, noir-gris-transparent

L 840, B 195, H 1045



E27



3x 40W



9 008606 235551



900196 AGUILARES

pendant light; steel, black / glass vaporized, black-grey-transparent

Hängeleuchte; Stahl, schwarz / Glas bedampft, schwarz-grau-transparent

luminaire en suspension; acier, noir / verre vaporisé, noir-gris-transparent

H 1100, Ø 430



E27



3x 40W



9 008606 235568

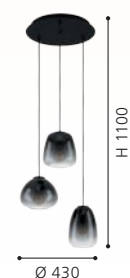



99314

99314 LEBALIO

pendant light; steel, bronzed / glass vaporized, black-transparent
 Hängeleuchte; Stahl, brüniert / Glas bedampft, schwarz-transparent
 luminaire en suspension; acier, brun / verre vaporisé, noir transparent

L 1125, B 195, H 1100



E27



3x 40W



9 002759 993146

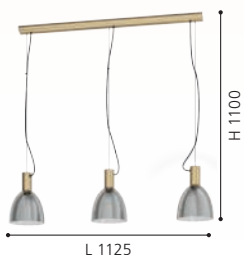

99314



900549



900551



EGLO
RECOMMENDS

110075

MARYVILLA

900549 MARYVILLA

pendant light; steel, black, bronzed / glass vaporized, clear, gold
Hängeleuchte; Stahl, schwarz, brüniert / Glas bedampft, klar, gold
luminaire en suspension; acier, noir, brun / verre vaporisé, transparent, or

H 1100, Ø 170



E27 1x 40W



9 008606 244553



900551 MARYVILLA

pendant light; steel, black, bronzed / glass vaporized, clear, gold
Hängeleuchte; Stahl, schwarz, brüniert / Glas bedampft, klar, gold
luminaire en suspension; acier, noir, brun / verre vaporisé, transparent, or

L 870, B 170, H 1100



E27 3x 40W



9 008606 244560



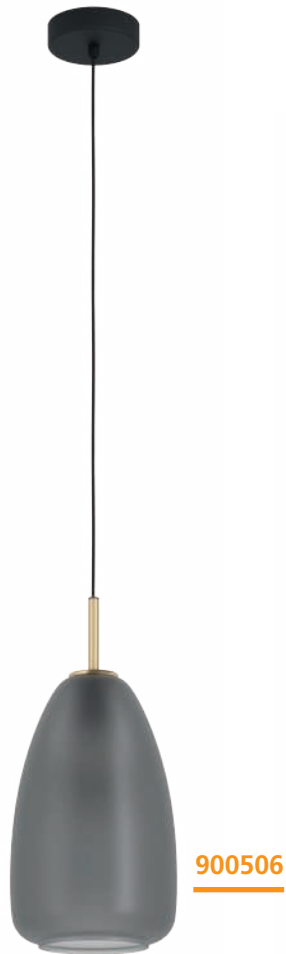

900506

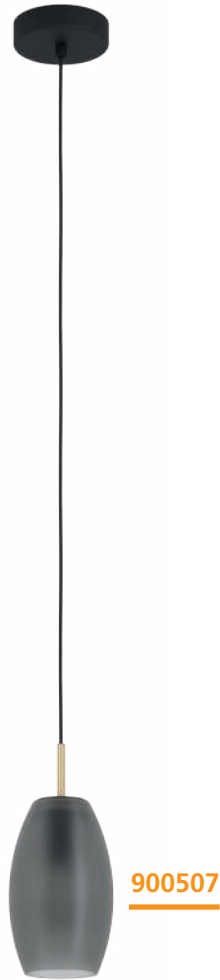

900507



900506 | 900507 | 900508



900508

900506 ALOBRASE

pendant light; steel, black, brushed brass / satin glass, grey matt
 Hängeleuchte; Stahl, schwarz, messing-gebürstet / Glas satiniert, grau matt
 luminaire en suspension; acier, noir, laiton brossé / verre satiné, gris mat

H 1100, Ø 200



900507 BATISTA

pendant light; steel, black, brushed brass / satin glass, grey matt
 Hängeleuchte; Stahl, schwarz, messing-gebürstet / Glas satiniert, grau matt
 luminaire en suspension; acier, noir, laiton brossé / verre satiné, gris mat

H 1100, Ø 120

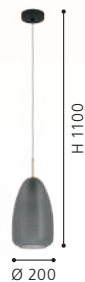

900508 BATISTA

pendant light; steel, black, brushed brass / satin glass, grey matt
 Hängeleuchte; Stahl, schwarz, messing-gebürstet / Glas satiniert, grau matt
 luminaire en suspension; acier, noir, laiton brossé / verre satiné, gris mat

L 945, B 120, H 1100

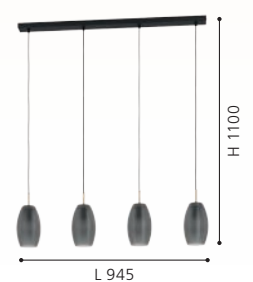



98614

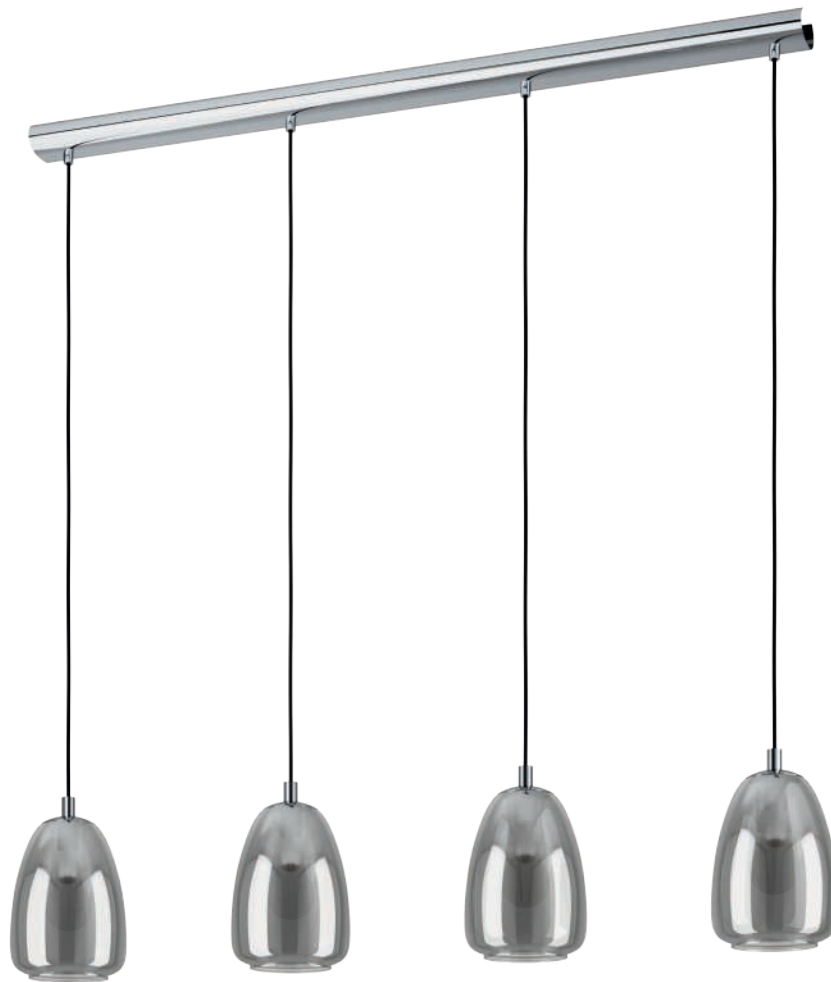

98616



ALOBRASE

98614 ALOBRASE

pendant light; steel, chrome / glass vaporized, black-transparent
 Hängeleuchte; Stahl, chrom / Glas bedampft, schwarz-transparent
 luminaire en suspension; acier, chrome / verre vaporisé, noir transparent

H 1100, Ø 300



98616 ALOBRASE

pendant light; steel, chrome / glass vaporized, black-transparent
 Hängeleuchte; Stahl, chrom / Glas bedampft, schwarz-transparent
 luminaire en suspension; acier, chrome / verre vaporisé, noir transparent

L 1080, B 150, H 1100



98615 ALOBRASE

pendant light; steel, chrome / glass vaporized, black-transparent
 Hängeleuchte; Stahl, chrom / Glas bedampft, schwarz-transparent
 luminaire en suspension; acier, chrome / verre vaporisé, noir transparent

H 1100, Ø 200

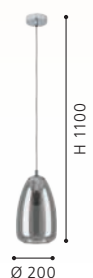

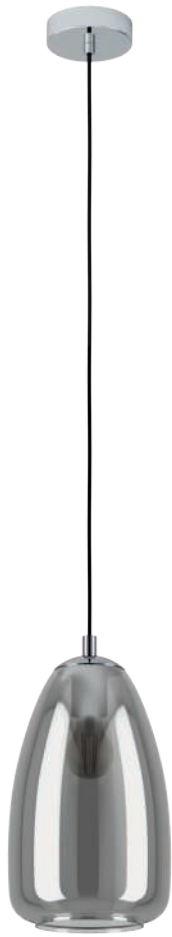

98615

98617 ALOBRASE

pendant light; steel, chrome / glass vaporized, black-transparent
Hängeleuchte; Stahl, chrom / Glas bedampft, schwarz-transparent
luminaire en suspension; acier, chrome / verre vaporisé, noir transparent

H 1500, Ø 540



E27



5x 40W



9 002759 986179

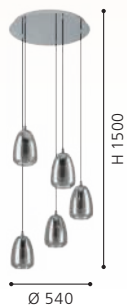

98617



98647





98648

98649

98647 ALOBRASE

pendant light; steel, brushed brass / glass vaporized, amber
 Hängeleuchte; Stahl, messing-gebürstet / Glas bedampft, amber
 luminaire en suspension; acier, laiton brossé / verre vaporisé, ambre

H 1100, Ø 300



98648 ALOBRASE

pendant light; steel, brushed brass / glass vaporized, amber
 Hängeleuchte; Stahl, messing-gebürstet / Glas bedampft, amber
 luminaire en suspension; acier, laiton brossé / verre vaporisé, ambre

H 1100, Ø 200



98649 ALOBRASE

pendant light; steel, brushed brass / glass vaporized, amber
 Hängeleuchte; Stahl, messing-gebürstet / Glas bedampft, amber
 luminaire en suspension; acier, laiton brossé / verre vaporisé, ambre

L 1080, B 150, H 1100

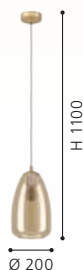

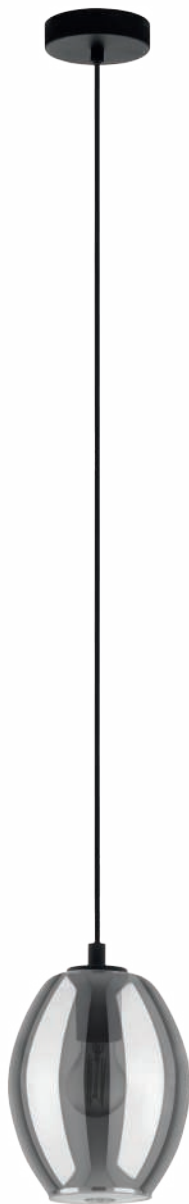

98582 | 98585

98582



98585



98291

98582 CADAQUES

pendant light; steel, black / smoked glass, black-transparent
Hängeleuchte; Stahl, schwarz / Rauchglas, schwarz-transparent
luminaire en suspension; acier, noir / verre fumé, noir transparent

H 1100, Ø 180



98585 CADAQUES 1

pendant light; steel, black / smoked glass, black-transparent
Hängeleuchte; Stahl, schwarz / Rauchglas, schwarz-transparent
luminaire en suspension; acier, noir / verre fumé, noir transparent

H 1100, Ø 160



98291 TORRONTES

pendant light; steel, nickel-nero / smoked glass, black-transparent
Hängeleuchte; Stahl, nickel-nero / Rauchglas, schwarz-transparent
luminaire en suspension; acier, nickel noir / verre fumé, noir transparent

H 1100, Ø 345

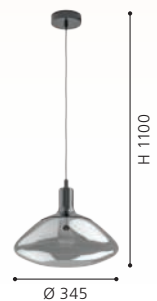

98291





ARISCANI

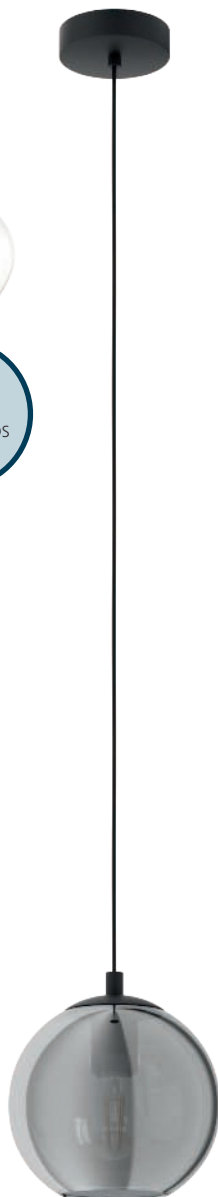

98651

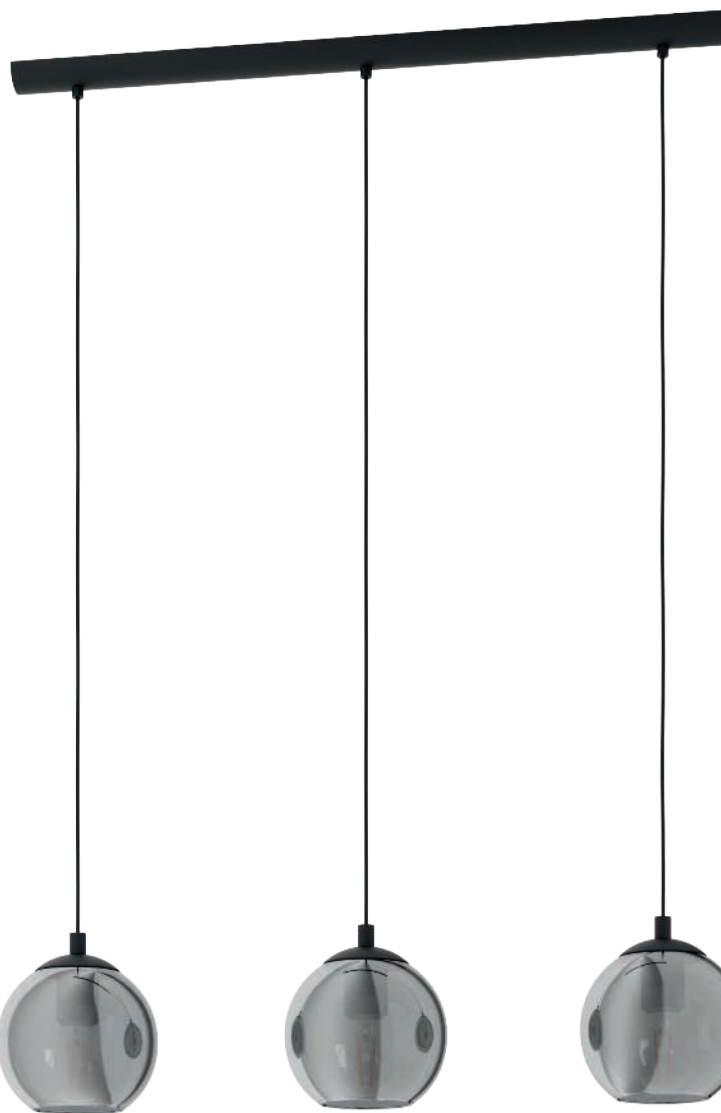

98652

98651 ARISCANI

pendant light; steel, black / glass vaporized, black-transparent
Hängeleuchte; Stahl, schwarz / Glas bedampft, schwarz-transparent

luminaire en suspension; acier, noir / verre vaporisé, noir transparent

H 1100, Ø 200



98652 ARISCANI

pendant light; steel, black / glass vaporized, black-transparent
Hängeleuchte; Stahl, schwarz / Glas bedampft, schwarz-transparent

luminaire en suspension; acier, noir / verre vaporisé, noir transparent

L 765, B 165, H 1100





98654



98653

98654 ARISCANI

pendant light; steel, black / glass vaporized, black-transparent
 Hängeleuchte; Stahl, schwarz / Glas bedampft, schwarz-transparent
 luminaire en suspension; acier, noir / verre vaporisé, noir transparent

H 1700, Ø 655



E27 10x 40W



9 002759 986544



98653 ARISCANI

pendant light; steel, black / glass vaporized, black-transparent
 Hängeleuchte; Stahl, schwarz / Glas bedampft, schwarz-transparent
 luminaire en suspension; acier, noir / verre vaporisé, noir transparent

H 1100, Ø 425



E27 3x 40W



9 002759 986537

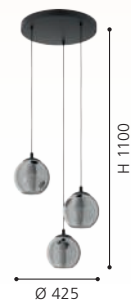



96774



96773



MURMILLO

96774 MURMILLO

pendant light; steel, chrome / smoked glass, black-transparent
 Hängeleuchte; Stahl, chrom / Rauchglas, schwarz-transparent
 luminaire en suspension; acier, chrome / verre fumé, noir transparent

L 770, B 170, H 1500



E27



3x 28W



9 002759 967741



96773 MURMILLO

pendant light; steel, chrome / smoked glass, black-transparent
 Hängeleuchte; Stahl, chrom / Rauchglas, schwarz-transparent
 luminaire en suspension; acier, chrome / verre fumé, noir transparent

H 1500, Ø 170



E27



1x 28W



9 002759 967734





96343

LED

96344

LED

96345

LED

96343 FARSALA

pendant light; steel, satin nickel / smoked glass, granilla, black-transparent, clear

Hängeleuchte; Stahl, nickel-matt / Rauchglas, Granille, schwarz-transparent, klar

luminaire en suspension; acier, nickel mat / verre fumé, granité, noir transparent, transparent

H 1100, Ø 125



G9



1x 3W



warm WHITE

1x

320lm



9 002759 963439



96344 FARSALA

pendant light; steel, satin nickel / smoked glass, granilla, black-transparent, clear

Hängeleuchte; Stahl, nickel-matt / Rauchglas, Granille, schwarz-transparent, klar

luminaire en suspension; acier, nickel mat / verre fumé, granité, noir transparent, transparent

L 975, B 100, H 1100



G9



4x 3W



warm WHITE

4x

320lm



9 002759 963446

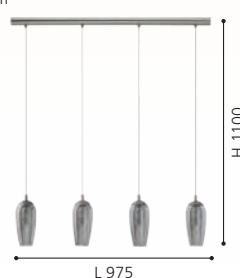

96345 FARSALA

pendant light; steel, satin nickel / smoked glass, granilla, black-transparent, clear

Hängeleuchte; Stahl, nickel-matt / Rauchglas, Granille, schwarz-transparent, klar

luminaire en suspension; acier, nickel mat / verre fumé, granité, noir transparent, transparent

H 1500, Ø 350



G9



5x 3W



warm WHITE

5x

320lm



9 002759 963453

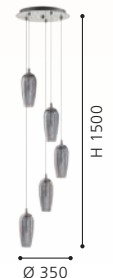



98384



DESIGN
HIGHLIGHT
DETAIL

98384 BELESER

pendant light; steel, black / glass vaporized, black-transparent
Hängeleuchte; Stahl, schwarz / Glas bedampft, schwarz-transparent

luminaire en suspension; acier, noir / verre vaporisé, noir transparent

L 905, B 205, H 1100



E27



3x 60W



9 002759 983840





98384 | 99371



99372



99371



99372

99371 MANTUNALLE 1

pendant light; steel, black / glass vaporized, black-transparent
 Hängeleuchte; Stahl, schwarz / Glas bedampft, schwarz-transparent
 luminaire en suspension; acier, noir / verre vaporisé, noir transparent

H 1100, Ø 200



E27 1x 40W



9 002759 993719



99372 MANTUNALLE 1

pendant light; steel, black / glass vaporized, black-transparent
 Hängeleuchte; Stahl, schwarz / Glas bedampft, schwarz-transparent
 luminaire en suspension; acier, noir / verre vaporisé, noir transparent

L 1200, B 200, H 1100



E27 3x 40W



9 002759 993726

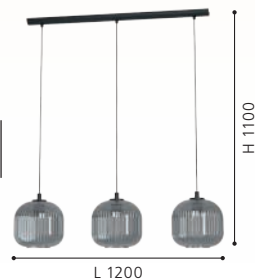



99366



99368



99366



99367 | 99368

99366 MANTUNALLE

pendant light; steel, black / glass, white
Hängeleuchte; Stahl, schwarz / Glas, weiss
luminaire en suspension; acier, noir / verre, blanc

H 1100, Ø 200



E27 1x 40W



9 002759 993665



99368 MANTUNALLE

pendant light; steel, black / glass, white
Hängeleuchte; Stahl, schwarz / Glas, weiss
luminaire en suspension; acier, noir / verre, blanc

H 1100, Ø 620



E27 3x 40W



9 002759 993689



99367 MANTUNALLE

pendant light; steel, black / glass, white
Hängeleuchte; Stahl, schwarz / Glas, weiss
luminaire en suspension; acier, noir / verre, blanc

L 1200, B 200, H 1100



E27 3x 40W



9 002759 993672



99367





98694



98694 | 98695



98695



98696

98694 SELVINO

pendant light; steel, satin nickel / glass vaporized, black-transparent

Hängeleuchte; Stahl, nickel-matt / Glas bedampft, schwarz-transparent

luminaire en suspension; acier, nickel mat / verre vaporisé, noir transparent

H 1100, Ø 100



E27



1x 15W



9 002759 986940



98695 SELVINO

pendant light; steel, satin nickel / glass vaporized, black-transparent

Hängeleuchte; Stahl, nickel-matt / Glas bedampft, schwarz-transparent

luminaire en suspension; acier, nickel mat / verre vaporisé, noir transparent

L 710, B 100, H 1100



E27



3x 15W



9 002759 986957



98696 SELVINO

pendant light; steel, satin nickel / glass vaporized, gold color

Hängeleuchte; Stahl, nickel-matt / Glas bedampft, goldfarben

luminaire en suspension; acier, nickel mat / verre vaporisé, couleur or

H 1100, Ø 100



E27



1x 15W



9 002759 986964





98697



98699



98698



98696 | 98697 | 98698 |
98699

98697 SELVINO

pendant light; steel, satin nickel / glass vaporized, gold color
Hängeleuchte; Stahl, nickel-matt / Glas bedampft, goldfarben
luminaire en suspension; acier, nickel mat / verre vaporisé, couleur or

L 710, B 100, H 1100



E27 3x 15W



9 002759 986971

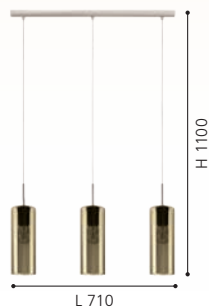

98698 SELVINO

pendant light; steel, satin nickel / glass vaporized, copper-coloured
Hängeleuchte; Stahl, nickel-matt / Glas bedampft, kupferfarben
luminaire en suspension; acier, nickel mat / verre vaporisé, cuivré

H 1100, Ø 100



E27 1x 15W



9 002759 986988



98699 SELVINO

pendant light; steel, satin nickel / glass vaporized, copper-coloured
Hängeleuchte; Stahl, nickel-matt / Glas bedampft, kupferfarben
luminaire en suspension; acier, nickel mat / verre vaporisé, cuivré

L 710, B 100, H 1100



E27 3x 15W



9 002759 986995

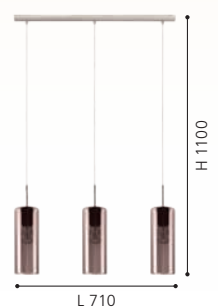

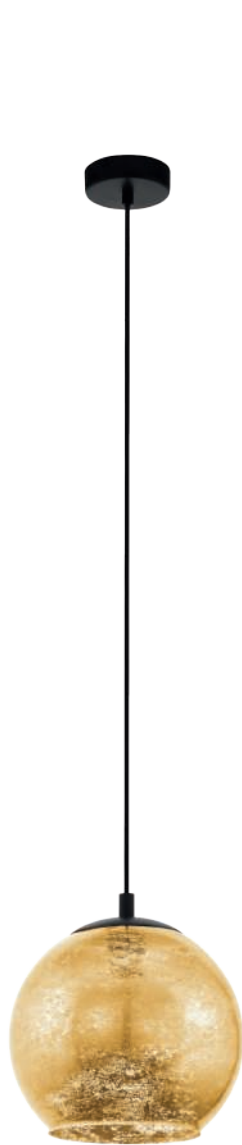

98523

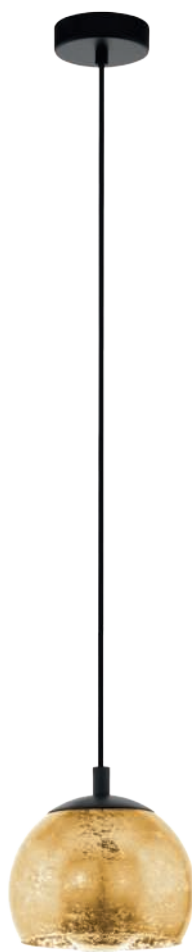

98524



98526

98523 ALBARACCIN

pendant light; steel, black / glass, gold color
Hängeleuchte; Stahl, schwarz / Glas, goldfarben
luminaire en suspension; acier, noir / verre, couleur or

H 1100, Ø 270



9 002759 985233



98524 ALBARACCIN

pendant light; steel, black / glass, gold color
Hängeleuchte; Stahl, schwarz / Glas, goldfarben
luminaire en suspension; acier, noir / verre, couleur or

H 1100, Ø 190



9 002759 985240



98526 ALBARACCIN

pendant light; steel, black / glass, gold color
Hängeleuchte; Stahl, schwarz / Glas, goldfarben
luminaire en suspension; acier, noir / verre, couleur or

H 1500, Ø 585



9 002759 985264





98525

98525 ALBARACCIN

pendant light; steel, black / glass, gold color

Hängeleuchte; Stahl, schwarz / Glas, goldfarben

luminaire en suspension; acier, noir / verre, couleur or

L 780, B 190, H 1100



E27



3x 40W



9 002759 985257





99654



99651

99654 LAGUNITAS

pendant light; steel, black, brass, gold / glass, clear
 Hängeleuchte; Stahl, schwarz, messing, gold / Glas, klar
 luminaire en suspension; acier, noir, laiton, or / verre, transparent

L 910, B 150, H 1100



E27



3x 40W



9 002759 996543



99651 LAGUNITAS

pendant light; steel, black, brass, gold / glass, clear
 Hängeleuchte; Stahl, schwarz, messing, gold / Glas, klar
 luminaire en suspension; acier, noir, laiton, or / verre, transparent

H 1100, Ø 150



E27



1x 40W



9 002759 996512





99628

LED

99629

LED



DESIGN
HIGHLIGHT
DETAIL

99628 CERASELLA

pendant light; steel, brushed brass / glass, clear
Hängeleuchte; Stahl, messing-gebürstet / Glas, klar
luminaire en suspension; acier, laiton brossé / verre, transparent

H 1100, Ø 200

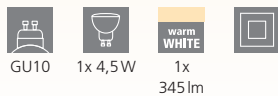

GU10 1x 4,5W
warm WHITE
1x 345lm



9 002759 996284



99629 CERASELLA

pendant light; steel, brushed brass / glass, clear
Hängeleuchte; Stahl, messing-gebürstet / Glas, klar
luminaire en suspension; acier, laiton brossé / verre, transparent

L 900, B 200, H 1100

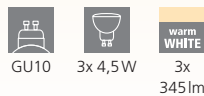

GU10 3x 4,5W
warm WHITE
3x 345lm



9 002759 996291



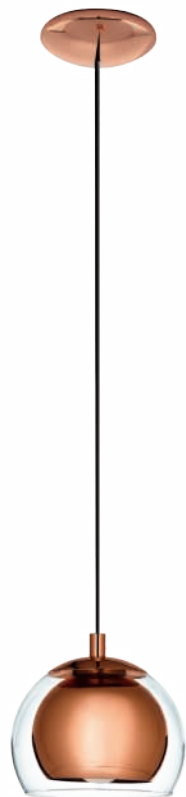

94589

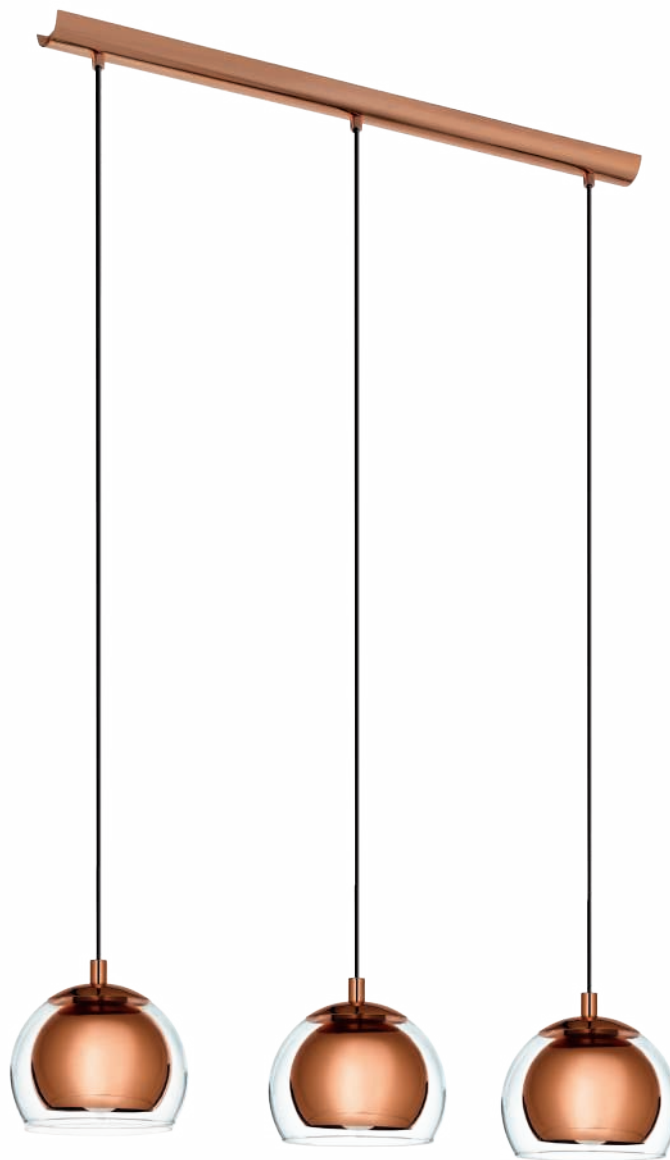

94591



94589 ROCAMAR

pendant light; steel, copper / glass, clear
Hängeleuchte; Stahl, kupfer / Glas, klar
luminaire en suspension; acier, cuivre / verre, transparent

H 1100, Ø 190



E27 1x 40W



9 002759 945893



94591 ROCAMAR

pendant light; steel, copper / glass, clear
Hängeleuchte; Stahl, kupfer / Glas, klar
luminaire en suspension; acier, cuivre / verre, transparent

L 780, B 190, H 1100



E27 3x 40W



9 002759 945916





98595



93836

98595 ROCAMAR 1

pendant light; steel, copper / glass, clear
 Hängeleuchte; Stahl, kupfer / Glas, klar
 luminaire en suspension; acier, cuivre / verre, transparent

H 1500, Ø 585

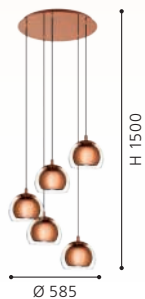

93836 CORETTO

pendant light; steel, brushed copper
 Hängeleuchte; Stahl, kupfer-gebürstet
 luminaire en suspension; acier, cuivre brossé

H 1100, Ø 170

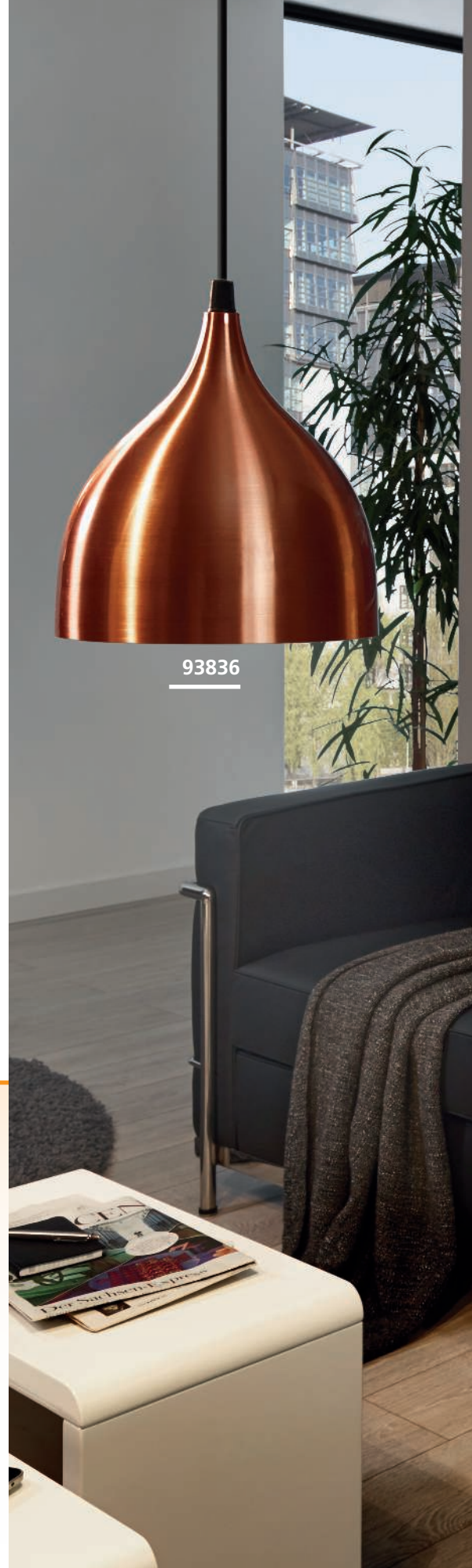
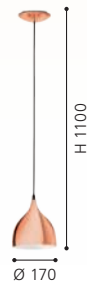



94592

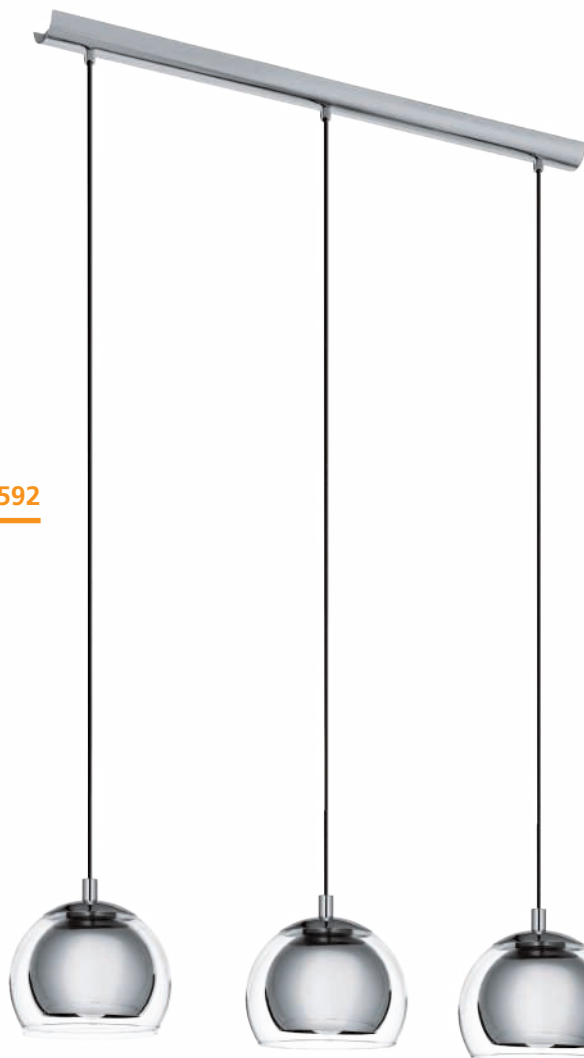

94593



98596

94592 ROCAMAR

pendant light; steel, chrome / glass, clear
Hängeleuchte; Stahl, chrom / Glas, klar
luminaire en suspension; acier, chrome / verre, transparent

H 1100, Ø 190



E27



1x 40W



9 002759 945923



94593 ROCAMAR

pendant light; steel, chrome / glass, clear
Hängeleuchte; Stahl, chrom / Glas, klar
luminaire en suspension; acier, chrome / verre, transparent

L 780, B 190, H 1100



E27



3x 40W



9 002759 945930



98596 ROCAMAR 1

pendant light; steel, chrome / glass, clear
Hängeleuchte; Stahl, chrom / Glas, klar
luminaire en suspension; acier, chrome / verre, transparent

H 1500, Ø 585



E27



5x 28W



9 002759 985967





94378



94377

DESIGN
HIGHLIGHT
DETAIL



LONGCINO 1

94378 LONGCINO 1

pendant light; steel, chrome / glass, satin glass, clear, white
Hängeleuchte; Stahl, chrom / Glas, Glas satiniert, klar, weiss
luminaire en suspension; acier, chrome / verre, verre satiné,
transparent, blanc

L 745, B 150, H 1100



E27



3x 60W



9 002759 943783



94377 LONGCINO 1

pendant light; steel, chrome / glass, satin glass, clear, white
Hängeleuchte; Stahl, chrom / Glas, Glas satiniert, klar, weiss
luminaire en suspension; acier, chrome / verre, verre satiné,
transparent, blanc

L 150, B 150, H 1100



E27



1x 60W



9 002759 943776

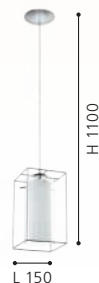



96528

LED

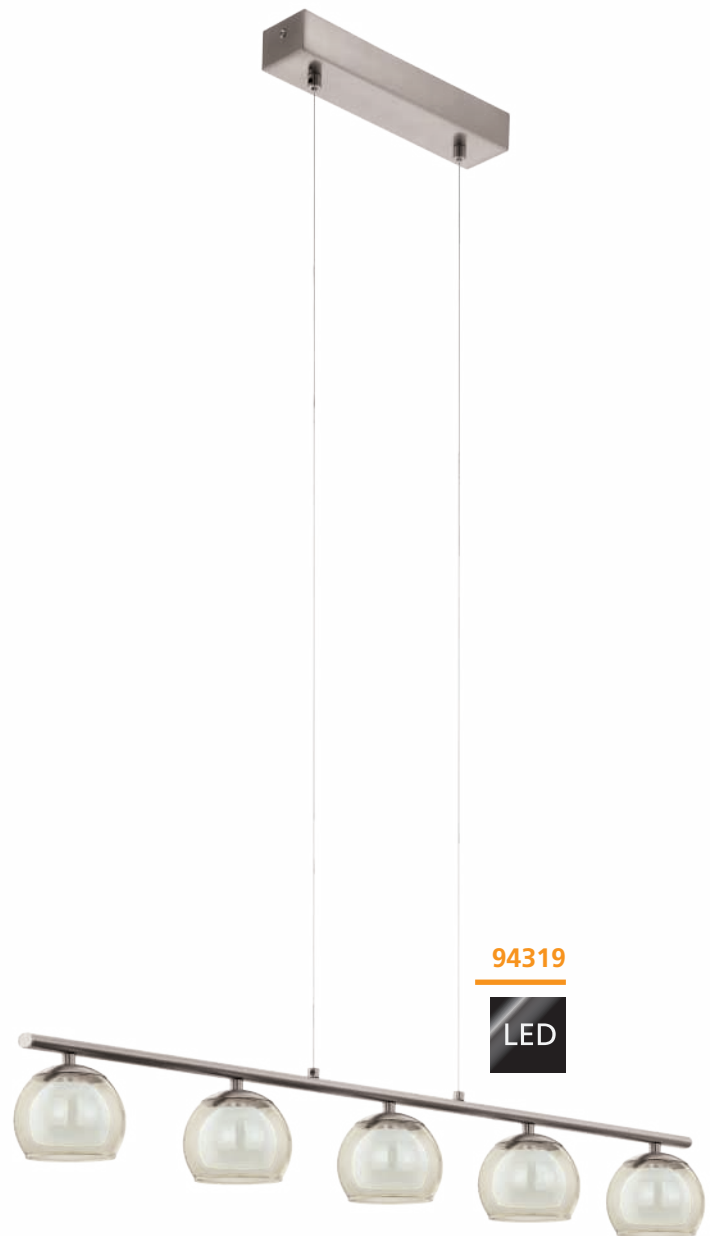

94319

LED

96528 ALEANDRO 1

pendant light; steel, chrome / glass opal-matt, white
 Hängeleuchte; Stahl, chrom / Glas opal-matt, weiss
 luminaire en suspension; acier, chrome / verre opale mat, blanc

L 800, B 120, H 860 - 1550



4x 4,5W 2000lm



9 002759 965280

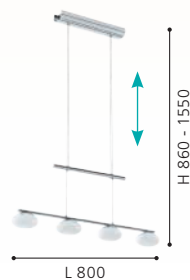

94319 ROMAGNESE

pendant light; steel, satin nickel / glass, satin glass, amber, white
 Hängeleuchte; Stahl, nickel-matt / Glas, Glas satiniert, ambre, weiss
 luminaire en suspension; acier, nickel mat / verre, verre satiné, ambre, blanc

L 900, B 105, H 1100



5x 3,3W 1700lm



9 002759 943196





97793



97587



97793



97587

97793 VALLASPRA

pendant light; steel, champagne / glass opal-matt, white
 Hängeleuchte; Stahl, champagner / Glas opal-matt, weiss
 luminaire en suspension; acier, champagne / verre opale mat, blanc

L 910, B 165, H 1100

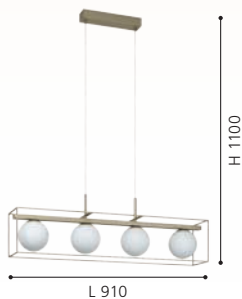

97587 BATISTA 3

pendant light; steel, satin nickel / glass wiping technique, white
 Hängeleuchte; Stahl, nickel-matt / Glas Wischtechnik, weiss
 luminaire en suspension; acier, nickel mat / technique de verre essuyé, blanc

L 1020, B 120, H 1100





92762



92761

92762 BOLSANO

pendant light; steel, chrome / satin glass, glass, white, clear
 Hängeleuchte; Stahl, chrom / Glas satiniert, Glas, weiss, klar
 luminaire en suspension; acier, chrome / verre satiné, verre, blanc, transparent

H 1300, Ø 505



E27 3x 60W



9 002759 927622



92761 BOLSANO

pendant light; steel, chrome / satin glass, glass, white, clear
 Hängeleuchte; Stahl, chrom / Glas satiniert, Glas, weiss, klar
 luminaire en suspension; acier, chrome / verre satiné, verre, blanc, transparent

H 1300, Ø 200



E27 1x 60W



9 002759 927615





CLEMENTE

95286



95287

95286 CLEMENTE

pendant light; steel, chrome / crystal, clear
 Hängeleuchte; Stahl, chrom / Kristall, klar
 luminaire en suspension; acier, chrome / cristal, transparent

H 1100, Ø 350



9 002759 952860

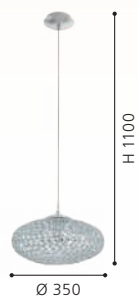

95287 CLEMENTE

pendant light; steel, chrome / crystal, clear
 Hängeleuchte; Stahl, chrom / Kristall, klar
 luminaire en suspension; acier, chrome / cristal, transparent

H 1100, Ø 540



9 002759 952877

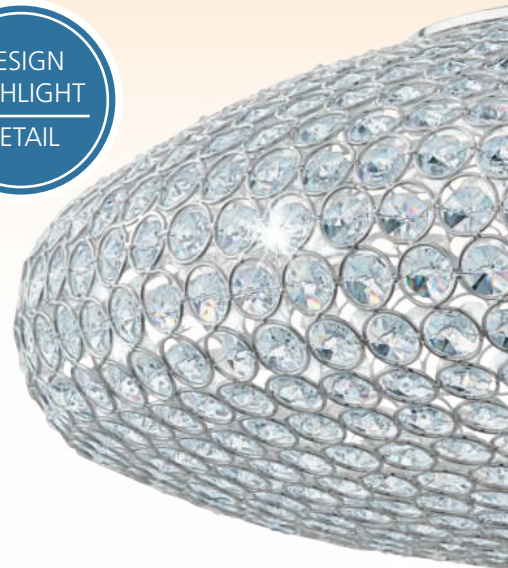



93625

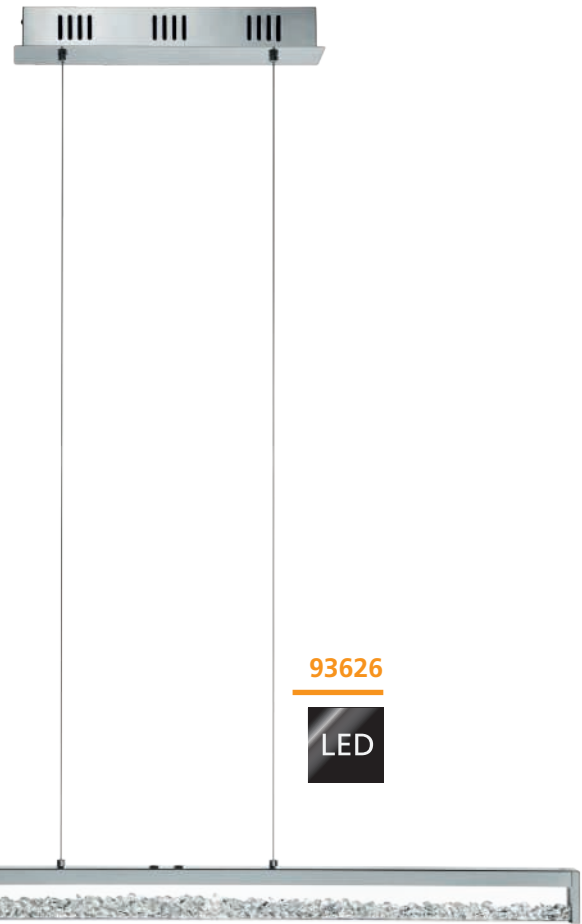

93626

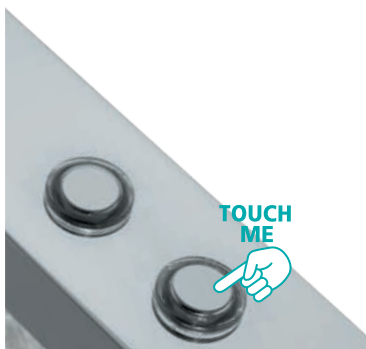

see the tunable white video
 unser Tunable White Video
 notre video de blanc réglable

CARDITO 1



Warm White 2700K Neutral White Cold White 5000K

These luminaires can be switched on and off by touching the specially designed "Touch Me" part of the fixture.

Features via touch-dimmer:

- > light colour adjustable between 2700K - 5000K
- > dimmable 10% - 100%

Diese Leuchten können ein und ausgeschaltet werden, indem man sie an den dafür vorgesehenen "Touch Me" Bereichen berührt. Per Touch-Dimmer verfügen diese Leuchten über folgende Funktionen:

- > Lichtfarbe einstellbar im Bereich 2700K bis 5000K
- > dimmbar 10% bis 100%

Ces luminaires peuvent être éteints et allumés simplement en touchant la partie spécialement conçue pour "Touch Me" du luminaire. Fonctions du gradateur "touch":

- > couleur lumineuse réglable de 2700K - 5000K
- > réglable en luminosité 10% - 100%

93625 CARDITO 1

pendant light; aluminium, steel, chrome / glass, crystal, clear
 Hängeleuchte; Alu, Stahl, chrom / Glas, Kristall, klar
 luminaire en suspension; aluminium, acier, chrome / verre, cristal, transparent

L 700, B 80, H 750 - 1300



4x 6W



2280lm



9 002759 936259

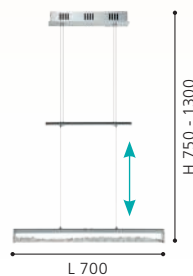

93626 CARDITO 1

pendant light; aluminium, steel, chrome / glass, crystal, clear
 Hängeleuchte; Alu, Stahl, chrom / Glas, Kristall, klar
 luminaire en suspension; aluminium, acier, chrome / verre, cristal, transparent

L 1000, B 80, H 1100



6x 6W



3420lm



9 002759 936266

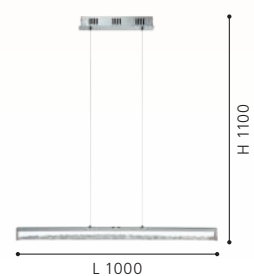



93092



31667

LED

93092 FEDRA 2

pendant light; steel, chrome / film, crystal, mother-of-pearl, clear
 Hängeleuchte; Stahl, chrom / Folie, Kristall, perlmutter, klar
 luminaire en suspension; acier, chrome / film, cristal, nacré, transparent

H 1100, Ø 250



9 002759 930929



31667 VARRAZO

pendant light; steel, chrome / crystal, clear
 Hängeleuchte; Stahl, chrom / Kristall, klar
 luminaire en suspension; acier, chrome / cristal, transparent

H 1200, Ø 550



9 002759 316679

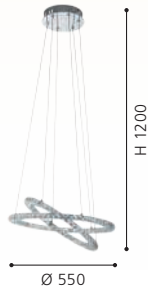

93092

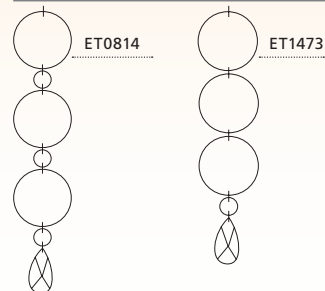



MONTEFIO 1

These luminaires come with high quality glass crystals.

Diese Leuchten sind mit hochwertigen Glaskristallen ausgestattet.

Ces luminaires viennent avec des cristaux de verre de haute qualité.



93073



93709



93073 LUBERIO

pendant light; steel, chrome / glass, aluminium, clear, aluminium
 Hängeleuchte; Stahl, chrom / Glas, Alu, klar, alu
 luminaire en suspension; acier, chrome / verre, aluminium, transparent, aluminium

H 1100, Ø 250



9 002759 930738



93709 MONTEFIO 1

pendant light; steel, chrome / glass, crystal, white, clear
 Hängeleuchte; Stahl, chrom / Glas, Kristall, weiss, klar
 luminaire en suspension; acier, chrome / verre, cristal, blanc, transparent

H 1100, Ø 400



9 002759 937096

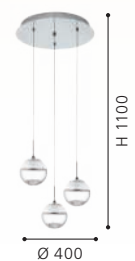

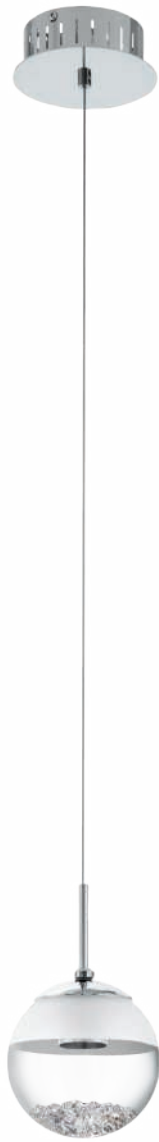

93708

LED



93784

LED

93708 MONTEFIO 1

pendant light; steel, chrome / glass, crystal, white, clear
 Hängeleuchte; Stahl, chrom / Glas, Kristall, weiss, klar
 luminaire en suspension; acier, chrome / verre, cristal, blanc, transparent

H 1100, Ø 140



1x 5W 480lm



9 002759 937089



93784 MONTEFIO 1

pendant light; steel, chrome / glass, crystal, white, clear
 Hängeleuchte; Stahl, chrom / Glas, Kristall, weiss, klar
 luminaire en suspension; acier, chrome / verre, cristal, blanc, transparent

L 870, B 140, H 1100



3x 5W 1440lm



9 002759 937843



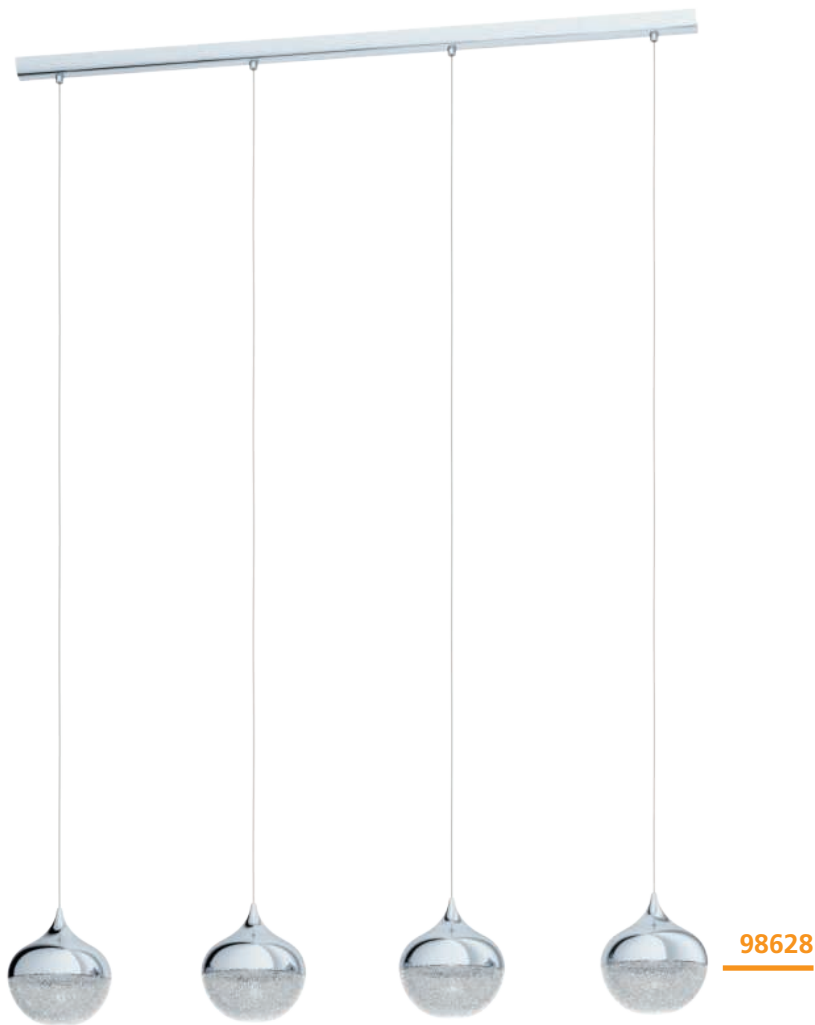

98628 MIOGLIA 1

pendant light; steel, chrome / plastic, granille white, clear
 Hängeleuchte; Stahl, chrom / Kunststoff, granille weiss, klar
 luminaire en suspension; acier, chrome / plastique, blanc granille, transparent

L 975, B 150, H 1100



9 002759 986285

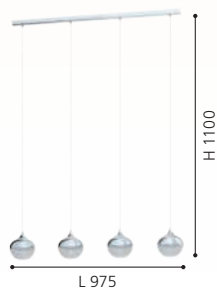

98629 MIOGLIA 1

pendant light; steel, chrome / plastic, granille white, clear
 Hängeleuchte; Stahl, chrom / Kunststoff, granille weiss, klar
 luminaire en suspension; acier, chrome / plastique, blanc granille, transparent

H 1500, Ø 540



9 002759 986292



95913 CONESSA

pendant light; steel, chrome / plastic, clear
 Hängeleuchte; Stahl, chrom / Kunststoff, klar
 luminaire en suspension; acier, chrome / plastique, transparent

H 1100, Ø 290



9 002759 959135





95912 CONESSA

pendant light; steel, chrome / plastic, clear
Hängeleuchte; Stahl, chrom / Kunststoff, klar
luminaire en suspension; acier, chrome / plastique, transparent

L 1010, B 150, H 1100

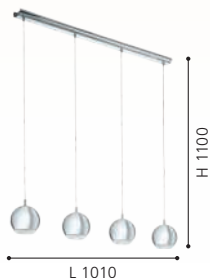
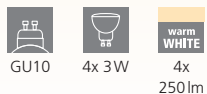

95914 CONESSA

pendant light; steel, chrome / plastic, clear
Hängeleuchte; Stahl, chrom / Kunststoff, klar
luminaire en suspension; acier, chrome / plastique, transparent

H 1700, Ø 580

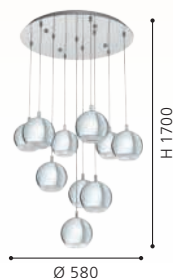



98678

LED



99107

LED

98678 ENALURI

pendant light; steel, satin nickel / plastic, satined
 Hängeleuchte; Stahl, nickel-matt / Kunststoff, satiniert
 luminaire en suspension; acier, nickel mat / plastique, satiné

L 140, B 105, H 1100

LED

warm
WHITE



1x 5,4W 630lm



9 002759 986780



99107 ENALURI

pendant light; steel, satin nickel / plastic, satined
 Hängeleuchte; Stahl, nickel-matt / Kunststoff, satiniert
 luminaire en suspension; acier, nickel mat / plastique, satiné

L 880, B 60, H 1100

LED

warm
WHITE



4x 5,4W 2520lm



9 002759 991074

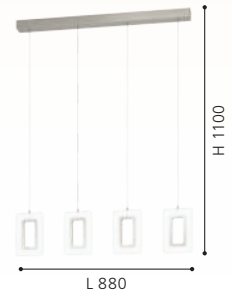

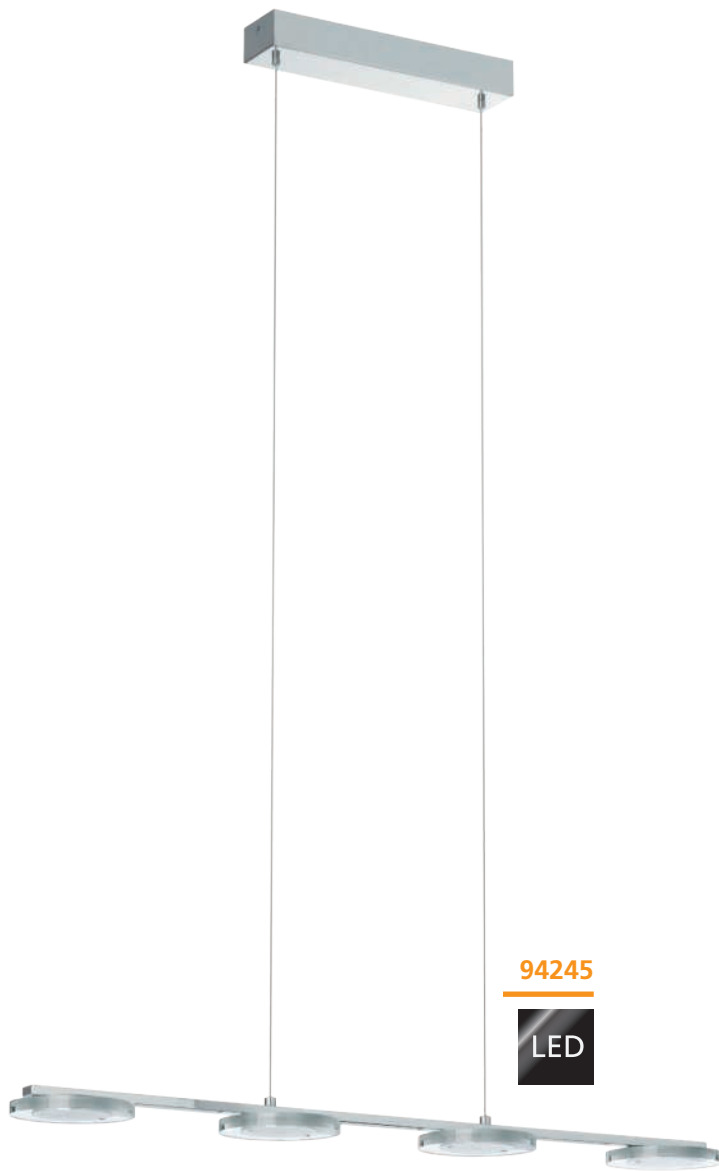

94245

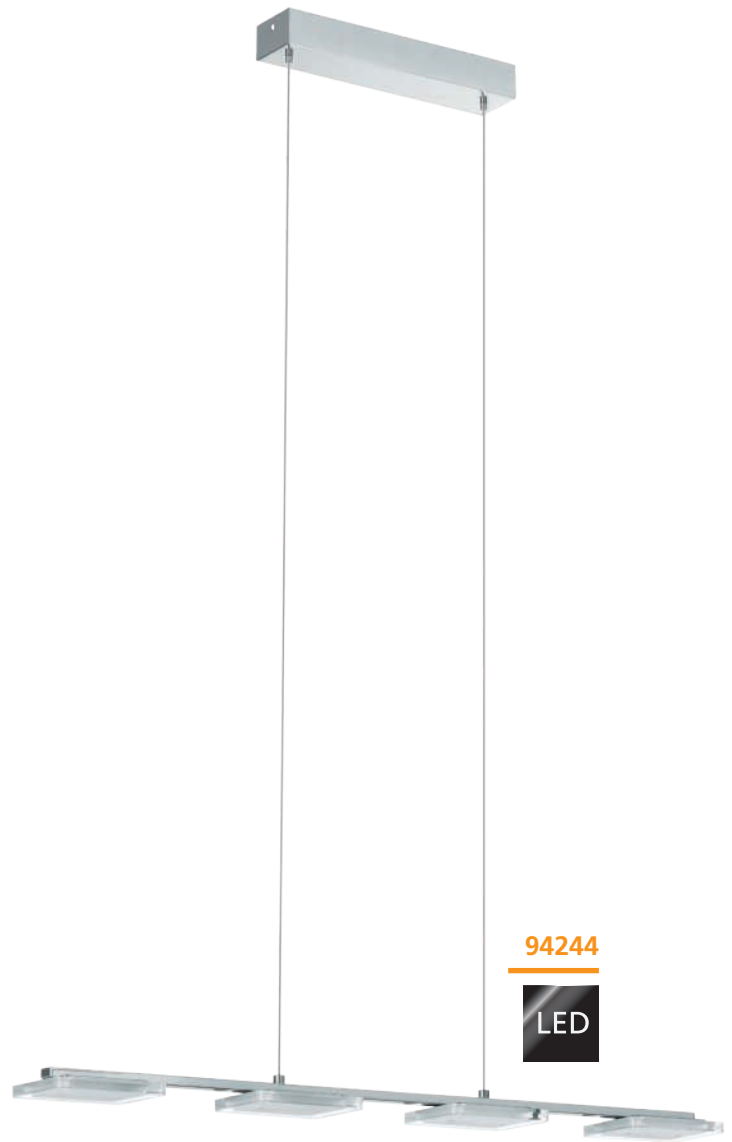

94244



94245 CARTAMA

pendant light; steel, chrome / plastic, clear, satined
 Hängeleuchte; Stahl, chrom / Kunststoff, klar, satiniert
 luminaire en suspension; acier, chrome / plastique, transparent, satiné

L 775, B 115, H 1100



4x 4,6W 2200lm



9 002759 942458

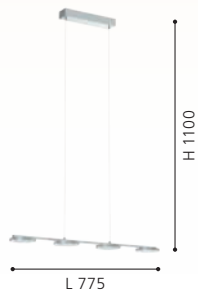

94244 CARTAMA

pendant light; steel, chrome / plastic, clear, satined
 Hängeleuchte; Stahl, chrom / Kunststoff, klar, satiniert
 luminaire en suspension; acier, chrome / plastique, transparent, satiné

L 780, B 90, H 1100



4x 4,6W 2200lm



9 002759 942441

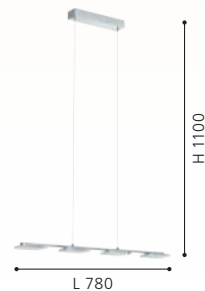



97366

97367

97366 MONTEFINO

pendant light; steel, black / glass, clear
 Hängeleuchte; Stahl, schwarz / Glas, klar
 luminaire en suspension; acier, noir / verre, transparent

H 1100, Ø 110



E27 1x 60W



9 002759 973667

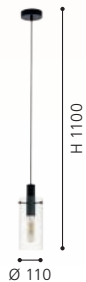

97367 MONTEFINO

pendant light; steel, black / glass, clear
 Hängeleuchte; Stahl, schwarz / Glas, klar
 luminaire en suspension; acier, noir / verre, transparent

L 730, B 110, H 1100



E27 3x 60W



9 002759 973674



97368 MONTEFINO

pendant light; steel, black / glass, clear
 Hängeleuchte; Stahl, schwarz / Glas, klar
 luminaire en suspension; acier, noir / verre, transparent

H 1500, Ø 350



E27 5x 60W



9 002759 973681





97368



98056



98058

98056 CORTENOVA

pendant light; steel, black
Hängeleuchte; Stahl, schwarz
luminaire en suspension; acier, noir

H 1100, Ø 105



E27



1x 60W



9 002759 980566

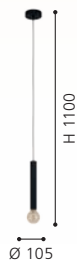

98058 CORTENOVA

pendant light; steel, black
Hängeleuchte; Stahl, schwarz
luminaire en suspension; acier, noir

H 1500, Ø 350



E27



5x 60W



9 002759 980580



98057 CORTENOVA

pendant light; steel, black
Hängeleuchte; Stahl, schwarz
luminaire en suspension; acier, noir

L 840, B 60, H 1100



E27



4x 60W



9 002759 980573





98057



98661





EGLO
RECOMMENDS
110112

POZUETA



98663



98662

98661 POZUETA

pendant light; steel, black
Hängeleuchte; Stahl, schwarz
luminaire en suspension; acier, noir

H 1100, Ø 125



E27 1x 40W



9 002759 986612



98663 POZUETA

pendant light; steel, black
Hängeleuchte; Stahl, schwarz
luminaire en suspension; acier, noir

H 1500, Ø 330



E27 3x 40W



9 002759 986636



98662 POZUETA

pendant light; steel, black
Hängeleuchte; Stahl, schwarz
luminaire en suspension; acier, noir

L 840, B 65, H 1100



E27 3x 40W



9 002759 986629





98346



98347

98346 BOCADILLA

pendant light; steel, black
 Hängeleuchte; Stahl, schwarz
 luminaire en suspension; acier, noir

H 1100, Ø 640



E27



9x 60W



9 002759 983468

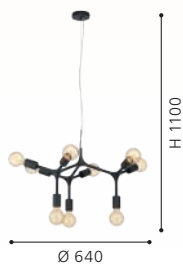

98347 BOCADILLA

pendant light; steel, black
 Hängeleuchte; Stahl, schwarz
 luminaire en suspension; acier, noir

H 1100, Ø 920



E27



12x 60W



9 002759 983475

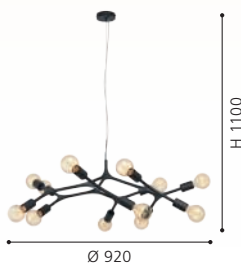

98909 MEZZANA

pendant light; steel, black
 Hängeleuchte; Stahl, schwarz
 luminaire en suspension; acier, noir

L 650, B 650, H 1100



E27



8x 40W



9 002759 989095

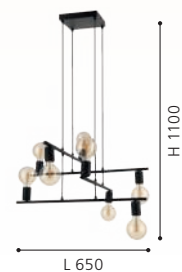



98909



98017



98016



99811

GRADOLI & GRADOLI 1

The arms of the luminaire can be swiveled individually.

Die Leuchtenarme sind individuell schwenkbar.

Les bras du luminaire peuvent être pivotés individuellement.

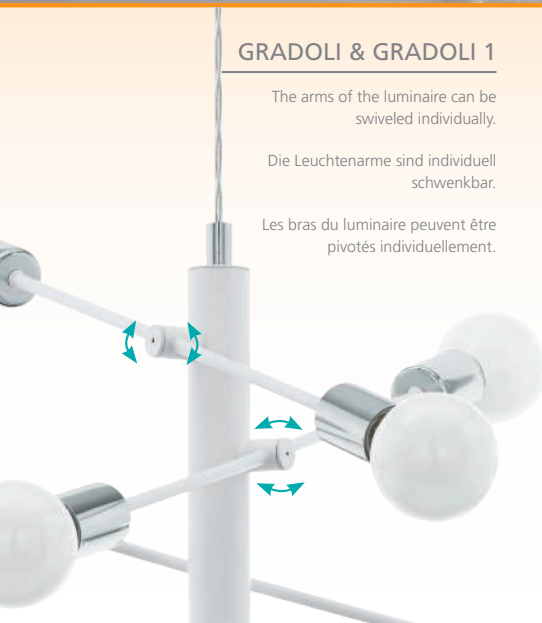

98017 GRADOLI

pendant light; steel, white, chrome
Hängeleuchte; Stahl, weiss, chrom
luminaire en suspension; acier, blanc, chrome

H 1100, Ø 710



9 002759 980177

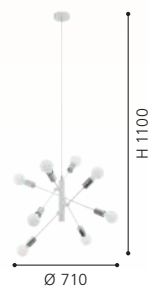

98016 GRADOLI

pendant light; steel, white, chrome
Hängeleuchte; Stahl, weiss, chrom
luminaire en suspension; acier, blanc, chrome

H 1100, Ø 550



9 002759 980160

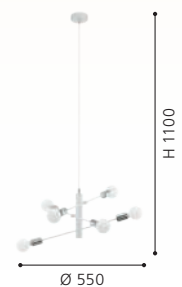



98835



MANIZALES



98834

99811 GRADOLI 1

pendant light; steel, brushed brass
Hängeleuchte; Stahl, messing-gebürstet
luminaire en suspension; acier, laiton brossé

H 1100, Ø 710



E27 8x 40W



9 002759 998110

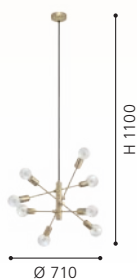

98835 MANIZALES

pendant light; steel, brushed brass
Hängeleuchte; Stahl, messing-gebürstet
luminaire en suspension; acier, laiton brossé

L 1010, B 50, H 1100



E27 3x 40W



9 002759 988357

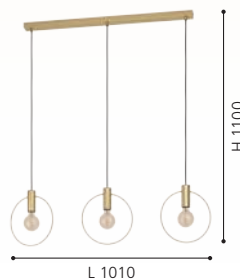

98834 MANIZALES

pendant light; steel, brushed brass
Hängeleuchte; Stahl, messing-gebürstet
luminaire en suspension; acier, laiton brossé

L 250, B 105, H 1100



E27 1x 40W



9 002759 988340

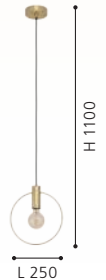



900399



97733

LED

900399 CUMIOLE

pendant light; steel, gold-coloured
 Hängeleuchte; Stahl, goldfarben
 luminaire en suspension; acier, or

L 780, B 150, H 1100



E27



3x 40W



9 008606 243754

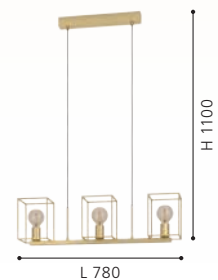



97733 MONTEBALDO

pendant light; steel, black, gold
 Hängeleuchte; Stahl, schwarz, gold
 luminaire en suspension; acier, noir, or

L 100, B 100, H 1100

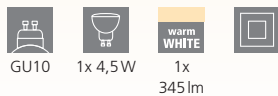

GU10 1x 4,5W
 1x
 warm WHITE
 345lm



9 002759 977337



97734 MONTEBALDO

pendant light; steel, black, gold
 Hängeleuchte; Stahl, schwarz, gold
 luminaire en suspension; acier, noir, or

L 850, B 100, H 1100



GU10 4x 4,5W
 4x
 warm WHITE
 345lm



9 002759 977344



98858 BITACHITO

pendant light; steel, black, brass
 Hängeleuchte; Stahl, schwarz, messing
 luminaire en suspension; acier, noir, laiton

L 930, B 55, H 1100



E27 4x 40W



9 002759 988586

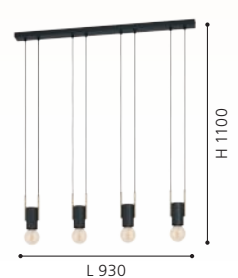



97604 CORTADERAS

pendant light; steel, black, gold
 Hängeleuchte; Stahl, schwarz, gold
 luminaire en suspension; acier, noir, or

H 1500, Ø 95

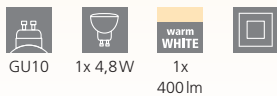

97605 CORTADERAS

pendant light; steel, black, gold
 Hängeleuchte; Stahl, schwarz, gold
 luminaire en suspension; acier, noir, or

L 1130, B 85, H 1500

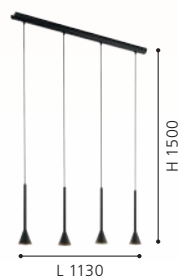
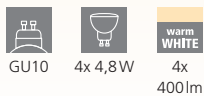

97606 CORTADERAS

pendant light; steel, black, gold
 Hängeleuchte; Stahl, schwarz, gold
 luminaire en suspension; acier, noir, or

H 1500, Ø 350

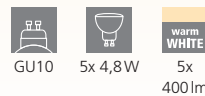



97606

LED



900401

LED



900402

LED

900401 SARONA

pendant light; steel, black, gold
Hängeleuchte; Stahl, schwarz, gold
luminaire en suspension; acier, noir, or

H 1100, Ø 210



GU10



1x 4,5W



1x
warm
WHITE
345lm



9 008606 243761



900402 SARONA

pendant light; steel, black, gold
Hängeleuchte; Stahl, schwarz, gold
luminaire en suspension; acier, noir, or

L 910, B 50, H 1100



GU10



3x 4,5W



3x
warm
WHITE
345lm



9 008606 243778

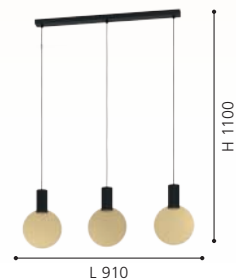

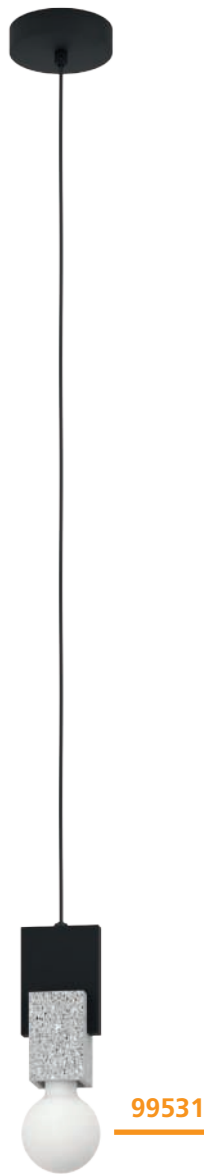

99531



99532

99531 LOBATIA

pendant light; steel, wood, black / terrazzo, grey, white
 Hängeleuchte; Stahl, Holz, schwarz / Terrazzo, grau, weiss
 luminaire en suspension; acier, bois, noir / terrazzo, gris, blanc

H 1100, Ø 105



99532 LOBATIA

pendant light; steel, wood, black / terrazzo, grey, white
 Hängeleuchte; Stahl, Holz, schwarz / Terrazzo, grau, weiss
 luminaire en suspension; acier, bois, noir / terrazzo, gris, blanc

L 925, B 55, H 1100





95522



95523

95522 SILVARES

pendant light; steel, grey / concrete, grey
Hängeleuchte; Stahl, grau / Beton, grau
luminaire en suspension; acier, gris / béton, gris

H 1100, Ø 110

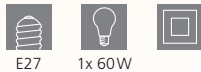

E27 1x 60W



95523 SILVARES

pendant light; steel, grey / concrete, grey
Hängeleuchte; Stahl, grau / Beton, grau
luminaire en suspension; acier, gris / béton, gris

H 1500, Ø 250



E27 3x 60W





95525



95526

95525 TAREGA

pendant light; steel, grey / wood, concrete, brown, grey
 Hängeleuchte; Stahl, grau / Holz, Beton, braun, grau
 luminaire en suspension; acier, gris / bois, béton, marron, gris

H 1100, Ø 150



9 002759 955250

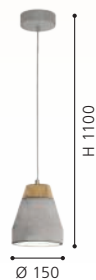

95526 TAREGA

pendant light; steel, grey / wood, concrete, brown, grey
 Hängeleuchte; Stahl, grau / Holz, Beton, braun, grau
 luminaire en suspension; acier, gris / bois, béton, marron, gris

H 1500, Ø 250



9 002759 955267





99464

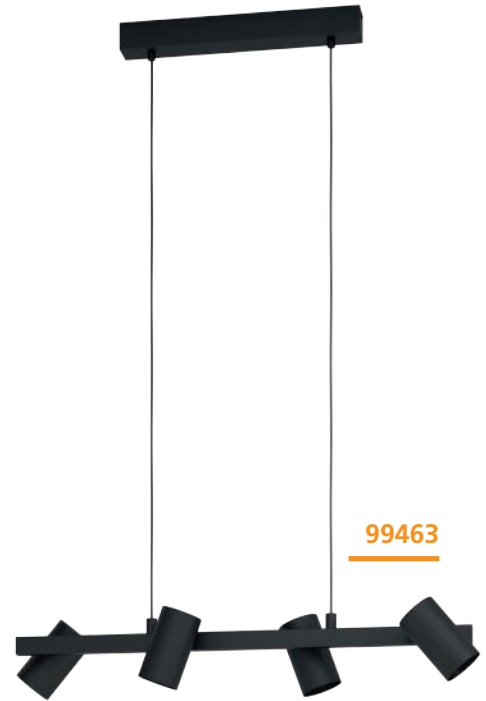

99463

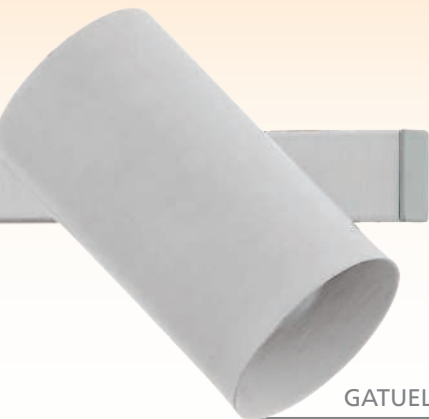

GATUELA, GATUELA 1

The lamp heads can be swiveled.

Die Leuchtenköpfe sind schwenkbar.

Les têtes de lampe peuvent être pivotées.

99464 GATUELA 1

pendant light; steel, black
Hängeleuchte; Stahl, schwarz
luminaire en suspension; acier, noir

L 1160, B 190, H 1100



E14



6x 25W



9 002759 994648

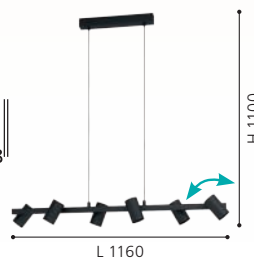

99463 GATUELA 1

pendant light; steel, black
Hängeleuchte; Stahl, schwarz
luminaire en suspension; acier, noir

L 760, B 190, H 1100



E14



4x 25W



9 002759 994631

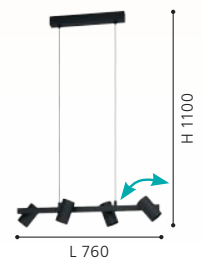



98687 GATUELA

pendant light; steel, white, satin nickel
 Hängeleuchte; Stahl, weiss, nickel-matt
 luminaire en suspension; acier, blanc, nickel mat

L 1160, B 190, H 1100

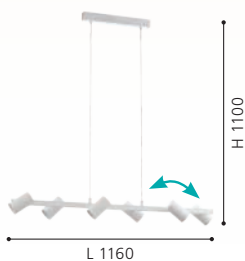

99819 ROVIRA

pendant light; aluminium, steel, silver / plastic, white
 Hängeleuchte; Alu, Stahl, silber / Kunststoff, weiss
 luminaire en suspension; aluminium, acier, argent / plastique, blanc

L 770, B 50, H 1100

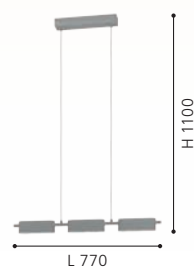

99821 ROVIRA

pendant light; aluminium, steel, black / plastic, white
 Hängeleuchte; Alu, Stahl, schwarz / Kunststoff, weiss
 luminaire en suspension; aluminium, acier, noir / plastique, blanc

L 770, B 50, H 1100



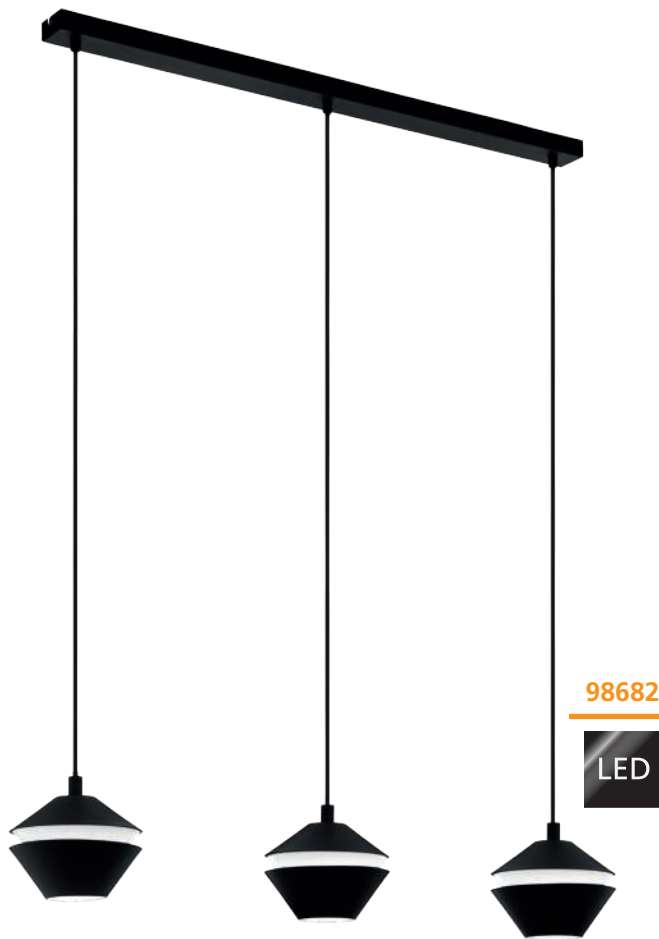

98682

LED

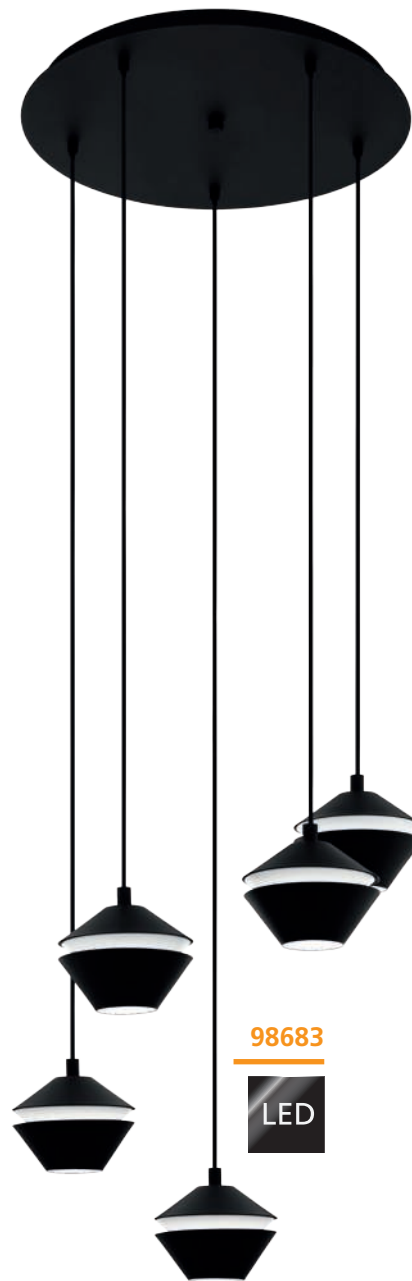

98683

LED

98682 PERPIGO

pendant light; steel, black / plastic, white
 Hängeleuchte; Stahl, schwarz / Kunststoff, weiss
 luminaire en suspension; acier, noir / plastique, blanc

L 865, B 165, H 1100

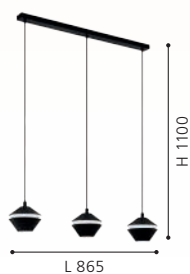
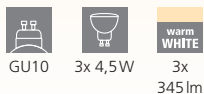

98683 PERPIGO

pendant light; steel, black / plastic, white
 Hängeleuchte; Stahl, schwarz / Kunststoff, weiss
 luminaire en suspension; acier, noir / plastique, blanc

H 1500, Ø 555



99013 PALBIETA

pendant light; steel, black / plastic, clear, satiné
 Hängeleuchte; Stahl, schwarz / Kunststoff, klar, satiniert
 luminaire en suspension; acier, noir / plastique, transparent, satiné

L 1160, B 115, H 1100

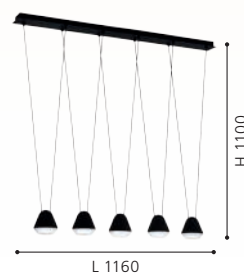



99013

LED



98492 AMONTILLADO

pendant light; aluminium, steel, black / plastic, white
 Hängeleuchte; Alu, Stahl, schwarz / Kunststoff, weiss
 luminaire en suspension; aluminium, acier, noir / plastique, blanc

L 1160, B 85, H 1100



2x 13,5W 3500lm



9 002759 984922

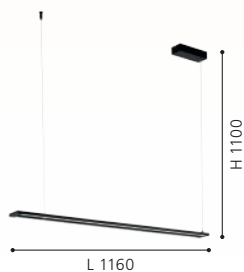

99599 CAMBULOS

pendant light; steel, black / plastic, white
 Hängeleuchte; Stahl, schwarz / Kunststoff, weiss
 luminaire en suspension; acier, noir / plastique, blanc

L 935, B 105, H 1100



2x 17W 4300lm



9 002759 995997



98495 SPADAFORA

pendant light; aluminium, steel, black / plastic, clear, white
 Hängeleuchte; Alu, Stahl, schwarz / Kunststoff, klar, weiss
 luminaire en suspension; aluminium, acier, noir / plastique, transparent, blanc

L 1160, B 80, H 1100



2x 7,5W 2000lm



9 002759 984953



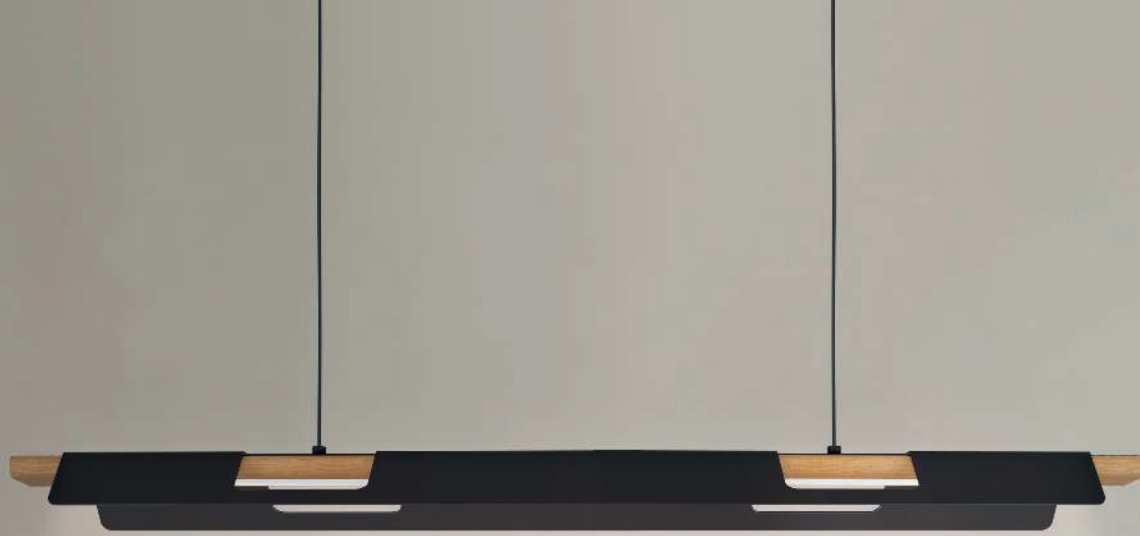

98836



98836 ERMUA

pendant light; steel, wood, black, brown / plastic, white
Hängeleuchte; Stahl, Holz, schwarz, braun / Kunststoff, weiss
luminaire en suspension; acier, bois, noir, marron / plastique, blanc

L 1000, B 165, H 1100



27W



3850lm



9 002759 988364

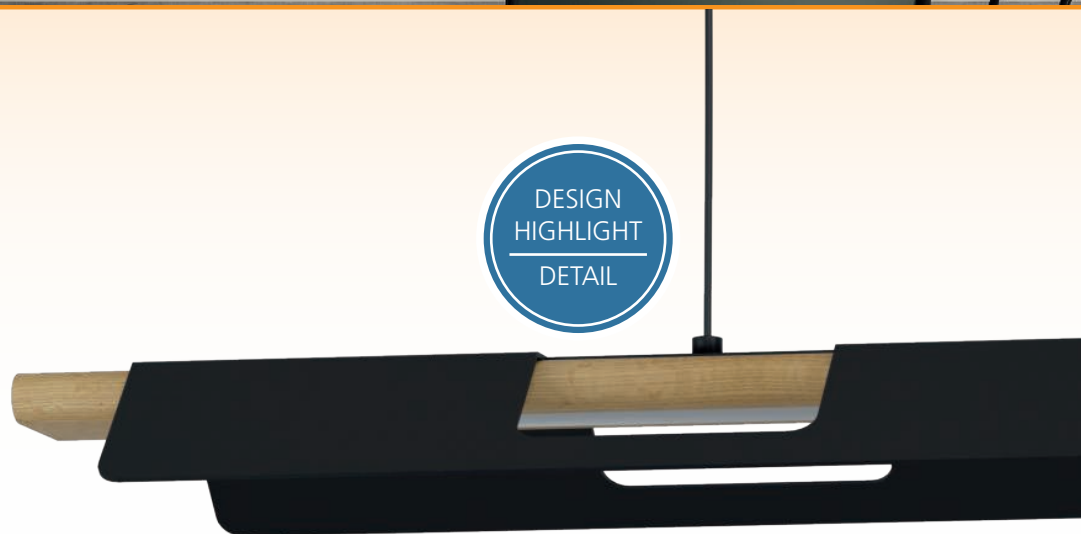



900175

LED



DESIGN
HIGHLIGHT
DETAIL



900174

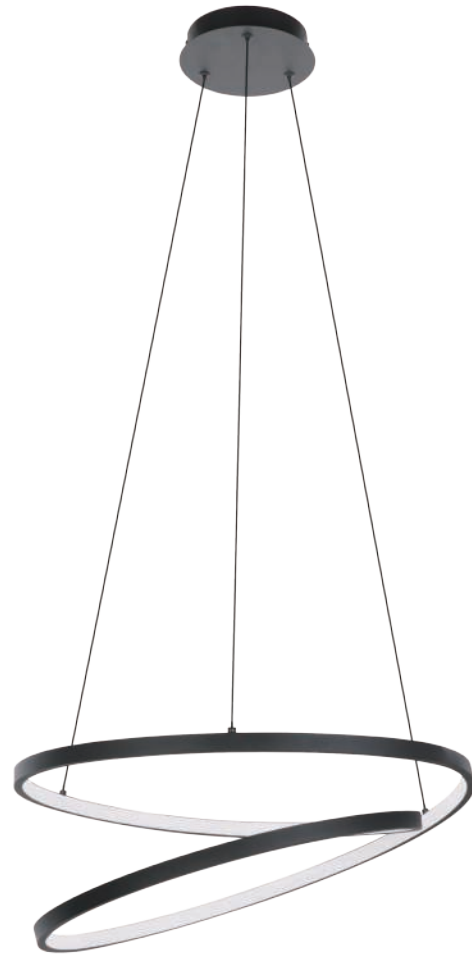

900472



900175 LISCIANA

pendant light; aluminium, steel, wood, grey / plastic, white
Hängeleuchte; Alu, Stahl, Holz, grau / Kunststoff, weiss
luminaire en suspension; aluminium, acier, bois, gris / plastique, blanc

L 1260, B 35, H 1100



22W 2500lm



9 008606 238088

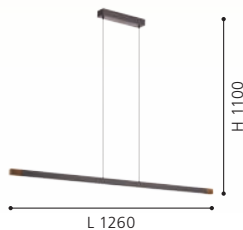

900174 LISCIANA

pendant light; aluminium, steel, wood, grey / plastic, white
Hängeleuchte; Alu, Stahl, Holz, grau / Kunststoff, weiss
luminaire en suspension; aluminium, acier, bois, gris / plastique, blanc

L 875, B 35, H 1100



18W 2000lm



9 008606 238071

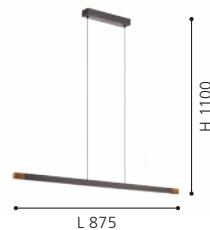

900472 RUOTALE

pendant light; aluminium, steel, black / plastic, white
Hängeleuchte; Alu, Stahl, schwarz / Kunststoff, weiss
luminaire en suspension; aluminium, acier, noir / plastique, blanc

H 1500, Ø 550



37W 4800lm



9 008606 239931

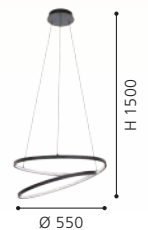



99818

LED



99249

LED

99818 SALITRE

pendant light; aluminium, black / plastic, white
 Hängeleuchte; Alu, schwarz / Kunststoff, weiss
 luminaire en suspension; aluminium, noir / plastique, blanc

H 1200, Ø 730



29W 4000lm

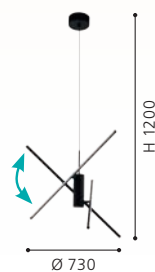

99249 CORREDERA

pendant light; steel, black / plastic, white
 Hängeleuchte; Stahl, schwarz / Kunststoff, weiss
 luminaire en suspension; acier, noir / plastique, blanc

H 1200, Ø 500



34W 5100lm

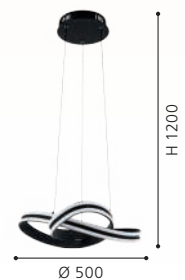

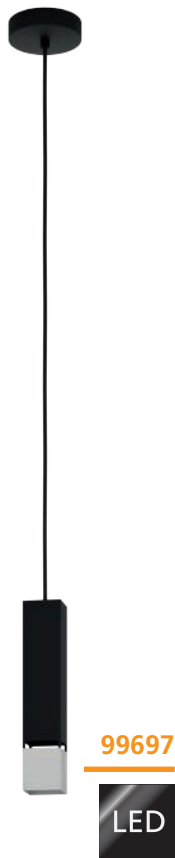

99697

LED



99698

LED

99697 BUTRANO

pendant light; steel, black, silver
 Hängeleuchte; Stahl, schwarz, silber
 luminaire en suspension; acier, noir, argent

L 55, B 55, H 1100

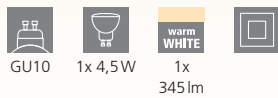

99698 BUTRANO

pendant light; steel, black, silver
 Hängeleuchte; Stahl, schwarz, silber
 luminaire en suspension; acier, noir, argent

L 770, B 55, H 1100





99073



99072



DESIGN
HIGHLIGHT
DETAIL

99073 MIRTAZZA

pendant light; steel, black / steel, champagne
Hängeleuchte; Stahl, schwarz / Stahl, champagner
luminaire en suspension; acier, noir / acier, champagne

H 1100, Ø 590



9 002759 990732



99072 MIRTAZZA

pendant light; steel, black / steel, champagne
Hängeleuchte; Stahl, schwarz / Stahl, champagner
luminaire en suspension; acier, noir / acier, champagne

L 880, B 180, H 1100



9 002759 990725

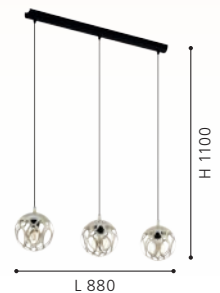



98688



98689



97066

98688 OKINZURI

pendant light; steel, nickel-nero
Hängeleuchte; Stahl, nickel-nero
luminaire en suspension; acier, nickel noir

H 1100, Ø 450



E27 1x 60W



9 002759 986889



98689 OKINZURI

pendant light; steel, brass
Hängeleuchte; Stahl, messing
luminaire en suspension; acier, laiton

H 1100, Ø 450

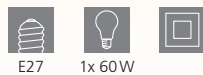

E27 1x 60W



9 002759 986896



97066 ESTEVAU

pendant light; steel, dark brown
Hängeleuchte; Stahl, dunkelbraun
luminaire en suspension; acier, marron foncé

L 975, B 145, H 1100



E27 4x 60W



9 002759 970666





92251

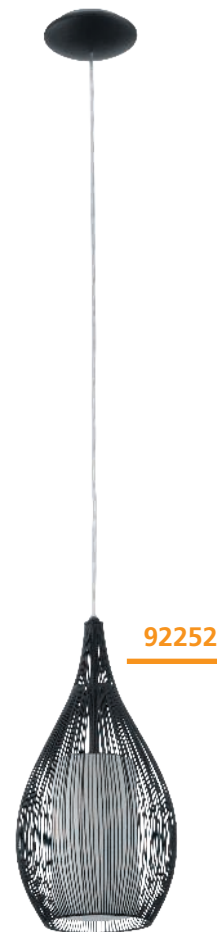

92252



RAZONI

92251 RAZONI

pendant light; steel, white / satin glass, steel, white
Hängeleuchte; Stahl, weiss / Glas satiniert, Stahl, weiss
luminaire en suspension; acier, blanc / verre satiné, acier, blanc

H 1300, Ø 190



E27



1x 60W



9 002759 922511





92252 RAZONI

pendant light; steel, black / satin glass, steel, black, white
 Hängeleuchte; Stahl, schwarz / Glas satiniert, Stahl, schwarz, weiss
 luminaire en suspension; acier, noir / verre satiné, acier, noir, blanc

H 1300, Ø 190



E27 1x 60W



9 002759 922528



94388 RAZONI

pendant light; steel, white / satin glass, steel, white
 Hängeleuchte; Stahl, weiss / Glas satiniert, Stahl, weiss
 luminaire en suspension; acier, blanc / verre satiné, acier, blanc

L 990, B 190, H 1100



E27 3x 60W



9 002759 943882



94389 RAZONI

pendant light; steel, black / satin glass, steel, black, white
 Hängeleuchte; Stahl, schwarz / Glas satiniert, Stahl, schwarz, weiss
 luminaire en suspension; acier, noir / verre satiné, acier, noir, blanc

L 990, B 190, H 1100



E27 3x 60W



9 002759 943899





DESIGN
HIGHLIGHT
DETAIL



99635 | 99636

99634

99636

99634 MASETA

pendant light; steel, black / smoked glass, black-transparent
Hängeleuchte; Stahl, schwarz / Rauchglas, schwarz-transparent
luminaire en suspension; acier, noir / verre fumé, noir transparent

L 930, B 225, H 1100



99636 MASETA

pendant light; steel, gold-coloured / glass opal-matt, white
Hängeleuchte; Stahl, goldfarben / Glas opal-matt, weiss
luminaire en suspension; acier, or / verre opale mat, blanc

L 930, B 225, H 1100



99635 MASETA

pendant light; steel, gold-coloured / glass opal-matt, white
Hängeleuchte; Stahl, goldfarben / Glas opal-matt, weiss
luminaire en suspension; acier, or / verre opale mat, blanc

H 1100, Ø 225



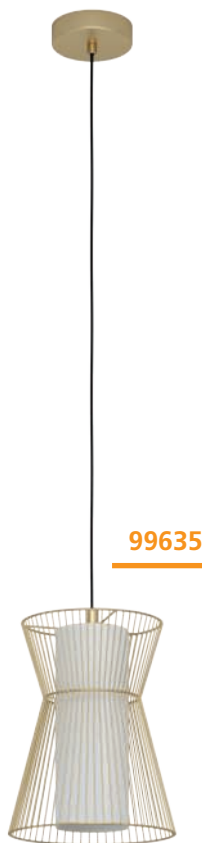

99633 | 99634

99633 MASETA

pendant light; steel, black / smoked glass, black-transparent
Hängeleuchte; Stahl, schwarz / Rauchglas, schwarz-transparent
luminaire en suspension; acier, noir / verre fumé, noir transparent

H 1100, Ø 225



E27



1x 40W

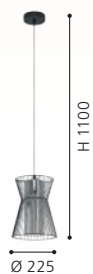



99705 FLORESTA

pendant light; steel, black / glass vaporized, black-transparent
 Hängeleuchte; Stahl, schwarz / Glas bedampft, schwarz-transparent
 luminaire en suspension; acier, noir / verre vaporisé, noir transparent

H 1100, Ø 195



99706 FLORESTA

pendant light; steel, black / glass vaporized, black-transparent
 Hängeleuchte; Stahl, schwarz / Glas bedampft, schwarz-transparent
 luminaire en suspension; acier, noir / verre vaporisé, noir transparent

L 890, B 190, H 1100



99707 ZOCABON

pendant light; steel, black / glass, clear
 Hängeleuchte; Stahl, schwarz / Glas, klar
 luminaire en suspension; acier, noir / verre, transparent

L 815, B 110, H 1100





99619 MULEGES

pendant light; steel, black / glass opal-matt, white
 Hängeleuchte; Stahl, schwarz / Glas opal-matt, weiss
 luminaire en suspension; acier, noir / verre opale mat, blanc

L 960, B 160, H 1100



99618 MULEGES

pendant light; steel, black / glass opal-matt, white
 Hängeleuchte; Stahl, schwarz / Glas opal-matt, weiss
 luminaire en suspension; acier, noir / verre opale mat, blanc

H 1100, Ø 160

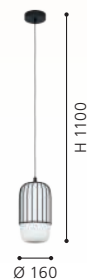



99661



99662

99661 CURASAO

pendant light; steel, black / steel, fabric, black, gold
 Hängeleuchte; Stahl, schwarz / Stahl, Textil, schwarz, gold
 luminaire en suspension; acier, noir / acier, tissu, noir, or

H 1100, Ø 335



99662 CURASAO

pendant light; steel, black / steel, fabric, black, gold
 Hängeleuchte; Stahl, schwarz / Stahl, Textil, schwarz, gold
 luminaire en suspension; acier, noir / acier, tissu, noir, or

L 995, B 235, H 1100



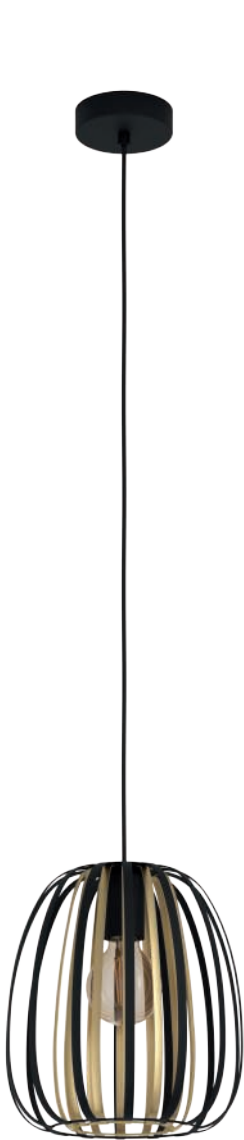

99665

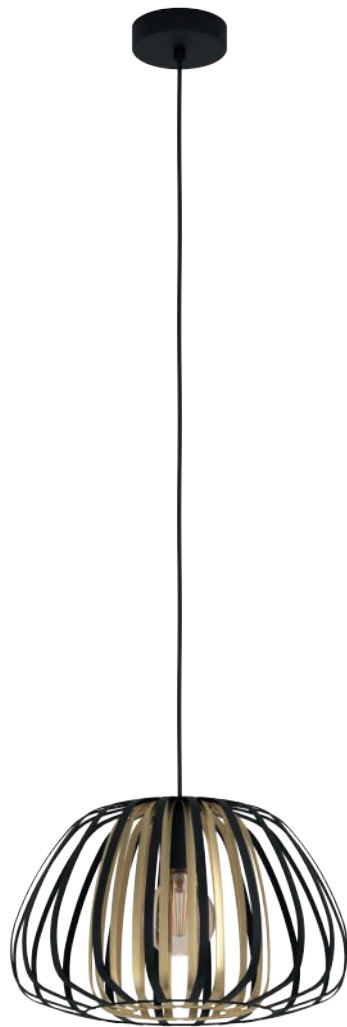

99666



99665 ENCINITOS

pendant light; steel, black, gold
Hängeleuchte; Stahl, schwarz, gold
luminaire en suspension; acier, noir, or

H 1100, Ø 255



E27 1x 40W



9 002759 996659



99666 ENCINITOS

pendant light; steel, black, gold
Hängeleuchte; Stahl, schwarz, gold
luminaire en suspension; acier, noir, or

H 1100, Ø 375



E27 1x 40W



9 002759 996666

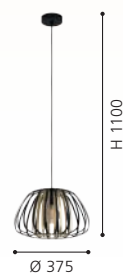



99694

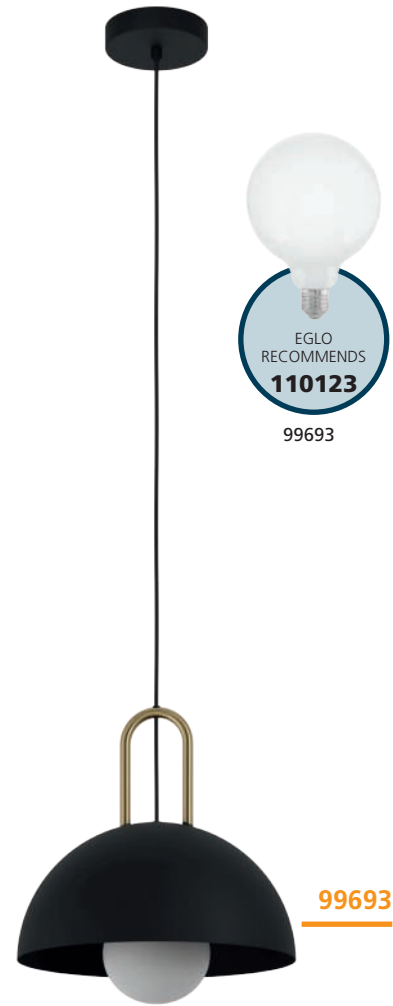

99693

99693

99694 CALMANERA

pendant light; steel, black, brass
 Hängeleuchte; Stahl, schwarz, messing
 luminaire en suspension; acier, noir, laiton

L 900, B 200, H 1100



E27



3x 40W



9 002759 996949



99693 CALMANERA

pendant light; steel, black, brass
 Hängeleuchte; Stahl, schwarz, messing
 luminaire en suspension; acier, noir, laiton

H 1100, Ø 325



E27



1x 40W



9 002759 996932

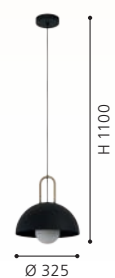



99695 | 99696

99696

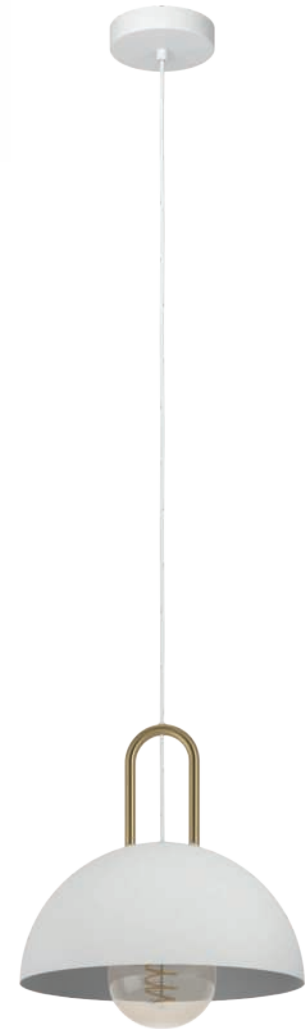

99695

99696 CALMANERA

pendant light; steel, white, brass
 Hängeleuchte; Stahl, weiss, messing
 luminaire en suspension; acier, blanc, laiton

L 900, B 200, H 1100



E27 3x 40W



9 002759 996963



99695 CALMANERA

pendant light; steel, white, brass
 Hängeleuchte; Stahl, weiss, messing
 luminaire en suspension; acier, blanc, laiton

H 1100, Ø 325



E27 1x 40W



9 002759 996956

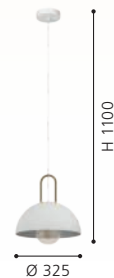



900429



900431

900429 VALDIOLA

pendant light; steel, sandy, brushed brass
 Hängeleuchte; Stahl, sandfarben, messing-gebürstet
 luminaire en suspension; acier, couleur sable, laiton brossé

H 1100, Ø 360



E27 1x 40W



9 008606 240562

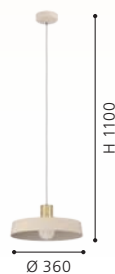

900431 VALDIOLA

pendant light; steel, sandy, brushed brass
 Hängeleuchte; Stahl, sandfarben, messing-gebürstet
 luminaire en suspension; acier, couleur sable, laiton brossé

L 930, B 230, H 1100



E27 3x 40W



9 008606 240579

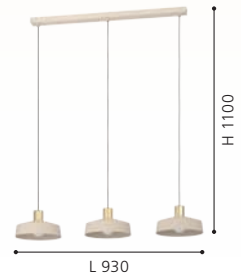



98839

LED



98838

LED

98839 LOSALOMAS

pendant light; steel, Mokka colour, brushed brass
 Hängeleuchte; Stahl, Mokkafarben, messing-gebürstet
 luminaire en suspension; acier, café, laiton brossé

L 835, B 135, H 1100



98838 LOSALOMAS

pendant light; steel, Mokka colour, brushed brass
 Hängeleuchte; Stahl, Mokkafarben, messing-gebürstet
 luminaire en suspension; acier, café, laiton brossé

H 1100, Ø 135

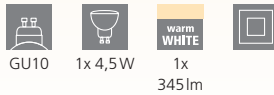



900425 BOLIVIA

pendant light; steel, black / steel, black, sandy
 Hängeleuchte; Stahl, schwarz / Stahl, schwarz, sandfarben
 luminaire en suspension; acier, noir / acier, noir, couleur sable

H 1100, Ø 180



900426 BOLIVIA

pendant light; steel, black / steel, black, sandy
 Hängeleuchte; Stahl, schwarz / Stahl, schwarz, sandfarben
 luminaire en suspension; acier, noir / acier, noir, couleur sable

L 880, B 180, H 1100



900143 CAMBAITO

pendant light; steel, sandy
 Hängeleuchte; Stahl, sandfarben
 luminaire en suspension; acier, couleur sable

L 895, B 195, H 1100

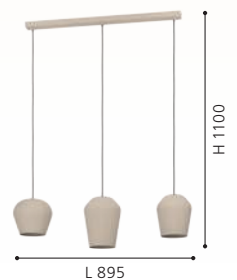

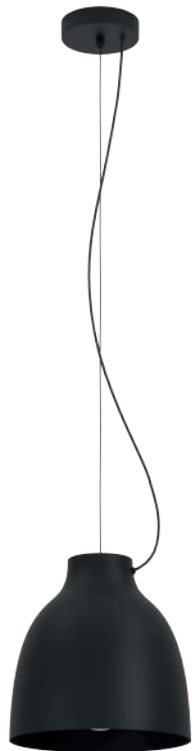

900158



900159

900158 CAMASCA

pendant light; steel, black
Hängeleuchte; Stahl, schwarz
luminaire en suspension; acier, noir

H 500 - 1100, Ø 280

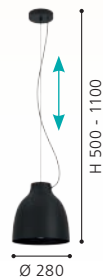

900159 CAMASCA

pendant light; steel, taupe
Hängeleuchte; Stahl, taupe
luminaire en suspension; acier, taupe

H 500 - 1100, Ø 280

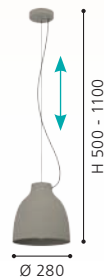

CAMASCA

These luminaires are height adjustable.
Diese Leuchten sind höhenverstellbar.
Ces luminaires sont réglables en hauteur.





900346



99438



900346 GAZZOLA

pendant light; steel, Mokka colour, sandy
 Hängeleuchte; Stahl, Mokka, Sandfarben
 luminaire en suspension; acier, café, couleur sable

L 910, B 150, H 1100



E27



5x 40W



9 008606 235889

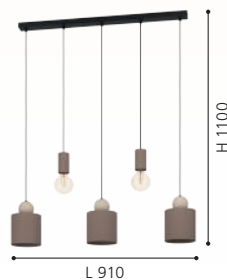

99438 SEGEZIA

pendant light; steel, Mokka colour / steel, Mokka colour, gold
 Hängeleuchte; Stahl, Mokkafarben / Stahl, Mokka, gold
 luminaire en suspension; acier, café / acier, Mokka, or

L 880, B 180, H 1100



E27



3x 40W



9 002759 994389





99439

99439 SEGEZIA

pendant light; steel, Mokka colour / steel, Mokka colour, gold
Hängeleuchte; Stahl, Mokkafarben / Stahl, Mokka, gold
luminaire en suspension; acier, café / acier, Mokka, or

H 1100, Ø 350



E27



1x 40W



9 002759 994396





98071

98071 CAMASTRA

pendant light; steel, black, gold
Hängeleuchte; Stahl, schwarz, gold
luminaire en suspension; acier, noir, or

H 1100, Ø 225



E27



1x 40W



9 002759 980719

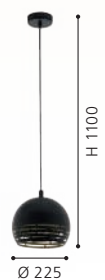



98353



98456

98353 RAMON

pendant light; steel, black / film, white
 Hängeleuchte; Stahl, schwarz / Folie, weiss
 luminaire en suspension; acier, noir / film, blanc

L 860, B 160, H 1100



9 002759 983536

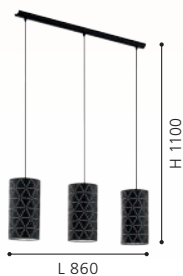

98456 CANTALLOPS

pendant light; steel, black, white
 Hängeleuchte; Stahl, schwarz, weiss
 luminaire en suspension; acier, noir, blanc

L 1150, B 520, H 1100



9 002759 984564

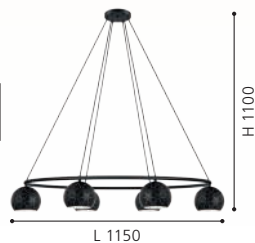



33345



97845



97841

33345 ROCCAFORTE

pendant light; steel, black, gold
Hängeleuchte; Stahl, schwarz, gold
luminaire en suspension; acier, noir, or

H 1100, Ø 170



E14 1x 40W



9 002759 333454

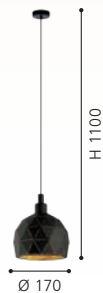

97845 ROCCAFORTE

pendant light; steel, black, gold
Hängeleuchte; Stahl, schwarz, gold
luminaire en suspension; acier, noir, or

H 1100, Ø 300



E27 1x 60W



9 002759 978457



97841 ROCCAFORTE

pendant light; steel, black, gold
Hängeleuchte; Stahl, schwarz, gold
luminaire en suspension; acier, noir, or

H 1100, Ø 400



E27 1x 60W



9 002759 978419

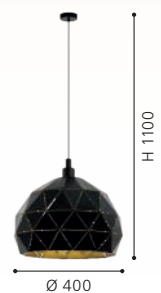



97846

97846 ROCCAFORTE

pendant light; steel, black, gold
Hängeleuchte; Stahl, schwarz, gold
luminaire en suspension; acier, noir, or

L 750, B 170, H 1100



E14 3x 40W



9 002759 978464

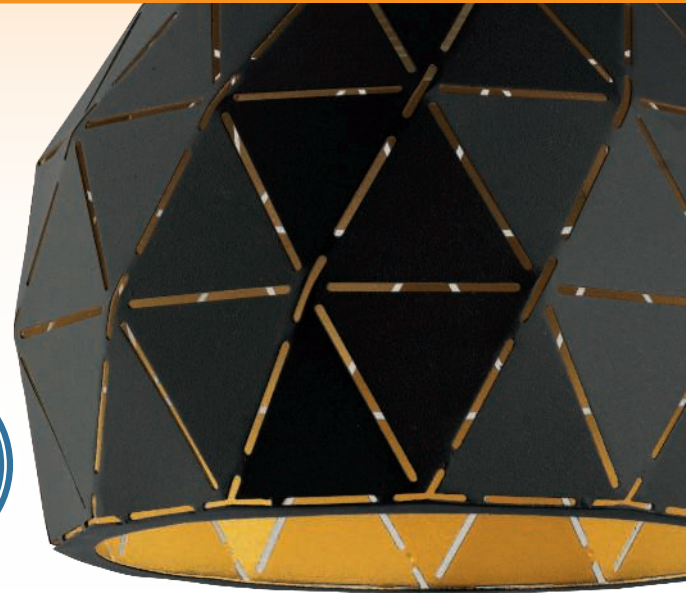



33344



97854

33344 ROCCAFORTE

pendant light; steel, white
Hängeleuchte; Stahl, weiss
luminaire en suspension; acier, blanc

H 1100, Ø 170



E14



1x 40W



9 002759 333447





97855

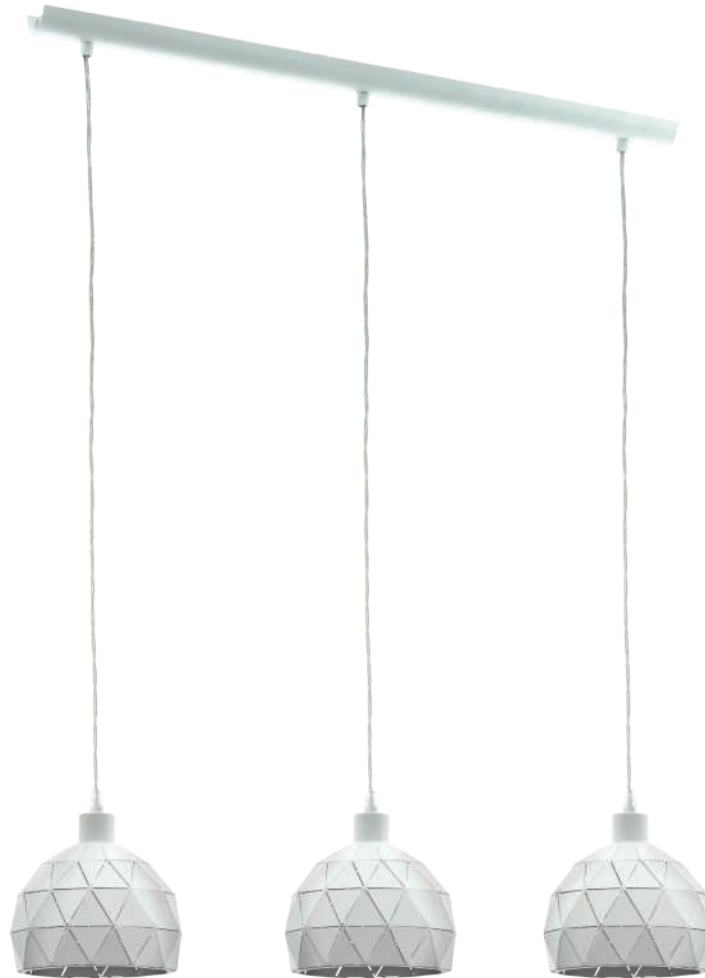

97857

97854 ROCCAFORTE

pendant light; steel, white
Hängeleuchte; Stahl, weiss
luminaire en suspension; acier, blanc

H 1100, Ø 300



E27 1x 60W



9 002759 978549



97855 ROCCAFORTE

pendant light; steel, white
Hängeleuchte; Stahl, weiss
luminaire en suspension; acier, blanc

H 1100, Ø 400



E27 1x 60W



9 002759 978556



97857 ROCCAFORTE

pendant light; steel, white
Hängeleuchte; Stahl, weiss
luminaire en suspension; acier, blanc

L 750, B 170, H 1100

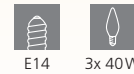

E14 3x 40W



9 002759 978570

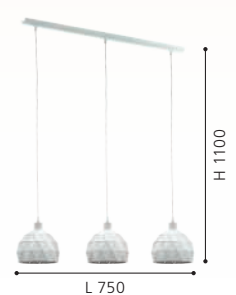



93373



93374



93373 CAMPILO

pendant light; plastic, white / paper threads, white
Hängeleuchte; Kunststoff, weiss / Papierfäden, weiss
luminaire en suspension; plastique, blanc / fils de papier, blanc

H 1100, Ø 450



9 002759 933739



93374 CAMPILO

pendant light; plastic, white / paper threads, beige
Hängeleuchte; Kunststoff, weiss / Papierfäden, beige
luminaire en suspension; plastique, blanc / fils de papier, beige

H 1100, Ø 450



9 002759 933746





95385



95383

95385 OBREGON

pendant light; steel, brown, creme, oak
 Hängeleuchte; Stahl, braun, creme, eiche
 luminaire en suspension; acier, marron, crème, chêne

H 1100, Ø 350



9 002759 953850

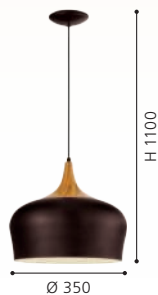

95383 OBREGON

pendant light; steel, creme, oak
 Hängeleuchte; Stahl, creme, eiche
 luminaire en suspension; acier, crème, chêne

H 1100, Ø 350



9 002759 953836





900161

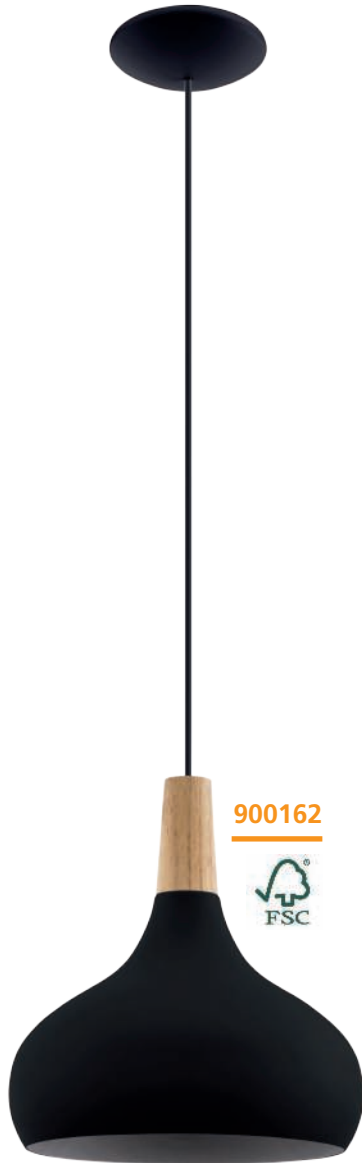

900162



900163



900161 SABINAR

pendant light; steel, wood, black, brown
 Hängeleuchte; Stahl, Holz, schwarz, braun
 luminaire en suspension; acier, bois, noir, marron

H 1100, Ø 180



E27

1x 40W



9 008606 235773



900162 SABINAR

pendant light; steel, wood, black, brown
 Hängeleuchte; Stahl, Holz, schwarz, braun
 luminaire en suspension; acier, bois, noir, marron

H 1100, Ø 280



E27

1x 40W



9 008606 235780



900163 SABINAR

pendant light; steel, wood, black, brown
 Hängeleuchte; Stahl, Holz, schwarz, braun
 luminaire en suspension; acier, bois, noir, marron

H 1100, Ø 400



E27

1x 40W



9 008606 235797

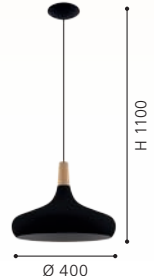



96981



96982



96983

96981 SABINAR

pendant light; steel, white / wood, brown
Hängeleuchte; Stahl, weiss / Holz, braun
luminaire en suspension; acier, blanc / bois, marron

H 1100, Ø 180

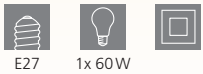

E27 1x 60W



9 002759 969813



96982 SABINAR

pendant light; steel, white / wood, brown
Hängeleuchte; Stahl, weiss / Holz, braun
luminaire en suspension; acier, blanc / bois, marron

H 1100, Ø 280



E27 1x 60W



9 002759 969820

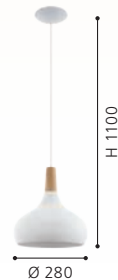

96983 SABINAR

pendant light; steel, white / wood, brown
Hängeleuchte; Stahl, weiss / Holz, braun
luminaire en suspension; acier, blanc / bois, marron

H 1100, Ø 400



E27 1x 60W



9 002759 969837





96985



96986



96985 SABINAR

pendant light; steel, brushed silver / wood, brown
 Hängeleuchte; Stahl, silber gebürstet / Holz, braun
 luminaire en suspension; acier, argent brossé / bois, marron

H 1100, Ø 280

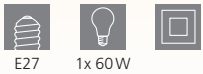

E27 1x 60W



9 002759 969851



96986 SABINAR

pendant light; steel, brushed silver / wood, brown
 Hängeleuchte; Stahl, silber gebürstet / Holz, braun
 luminaire en suspension; acier, argent brossé / bois, marron

H 1100, Ø 400



E27 1x 60W



9 002759 969868





900186

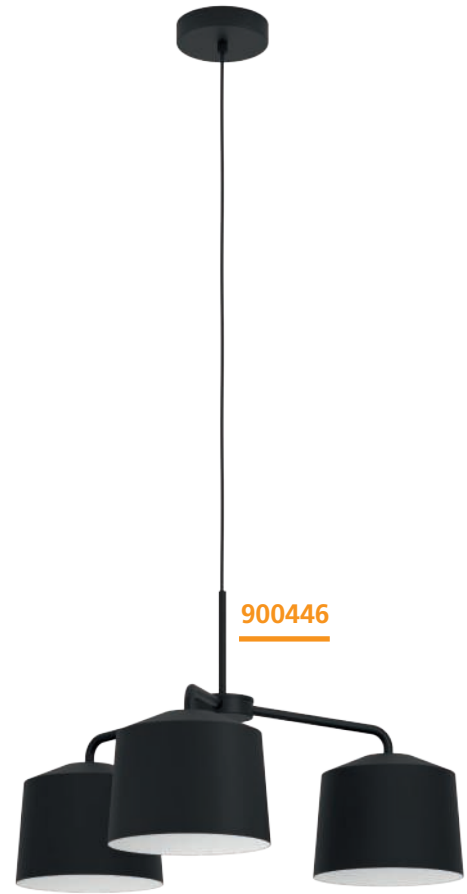

900446



900186 FILAGO

pendant light; steel, wood, black, brown / glass, black-grey-transparent
 Hängeleuchte; Stahl, Holz, schwarz, braun / Glas, schwarz-grau-transparent
 luminaire en suspension; acier, bois, noir, marron / verre, noir-gris-transparent
 L 880, B 145, H 1100



900446 CAGUANES

pendant light; steel, black, white
 Hängeleuchte; Stahl, schwarz, weiss
 luminaire en suspension; acier, noir, blanc

H 1100, Ø 665

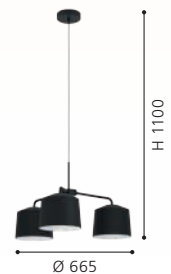



99702 VIGLIONI

pendant light; steel, wood, black, brown / glass vaporized, black-transparent

Hängeleuchte; Stahl, Holz, schwarz, braun / Glas bedampft, schwarz-transparent

luminaire en suspension; acier, bois, noir, marron / verre vaporisé, noir transparent

L 1060, B 165, H 1100



E27 3x 40W



9 002759 997021

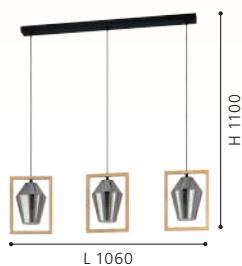

99701 VIGLIONI

pendant light; steel, wood, black, brown / glass vaporized, black-transparent

Hängeleuchte; Stahl, Holz, schwarz, braun / Glas bedampft, schwarz-transparent

luminaire en suspension; acier, bois, noir, marron / verre vaporisé, noir transparent

L 230, B 165, H 1100



E27 1x 40W



9 002759 997014



900444 TARRAFO

pendant light; steel, wood, black, brown

Hängeleuchte; Stahl, Holz, schwarz, braun

luminaire en suspension; acier, bois, noir, marron

L 880, B 150, H 1100



E27 4x 40W



9 008606 243952

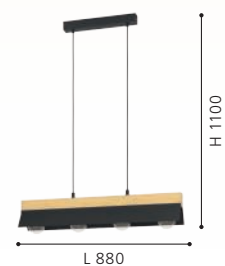

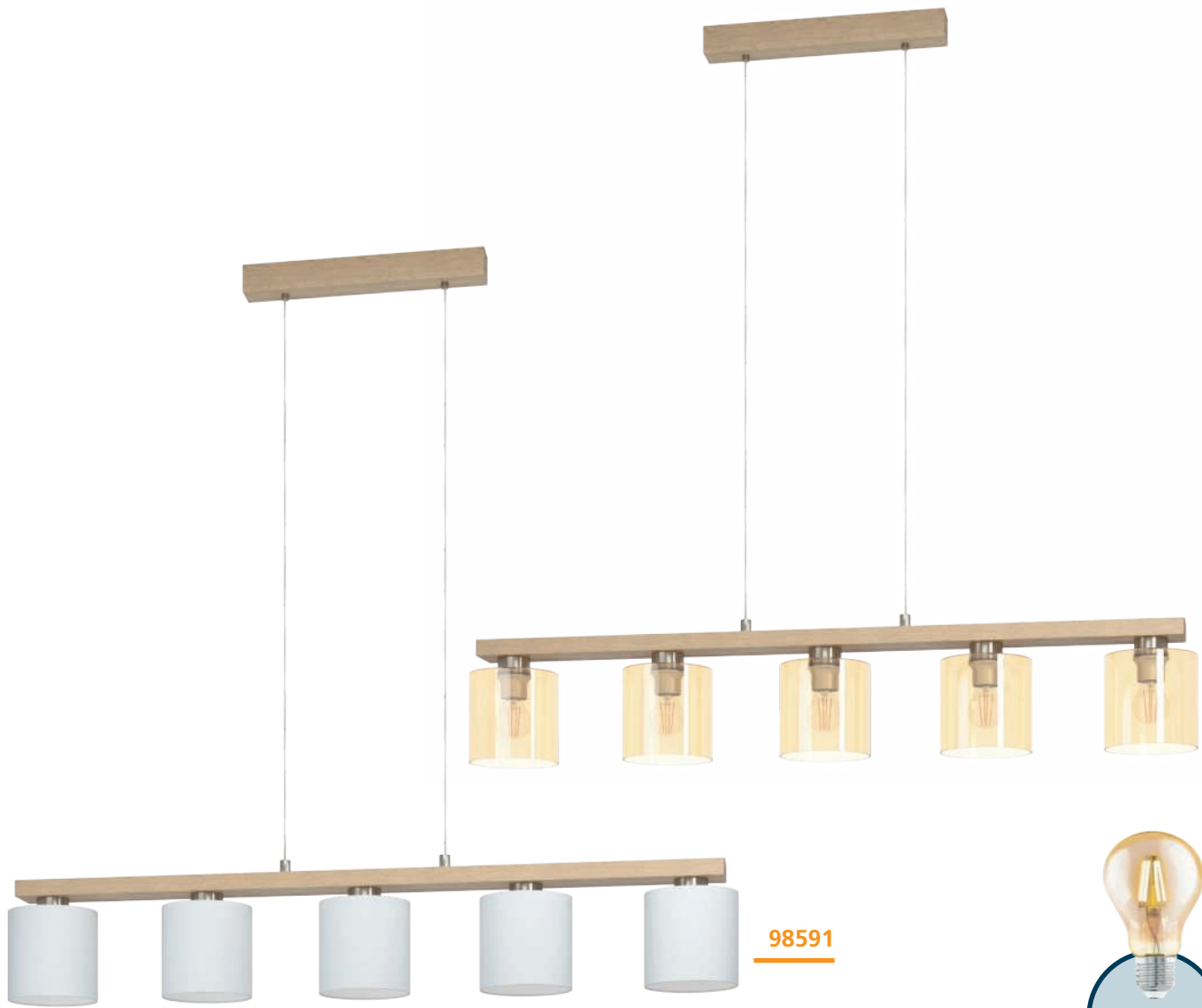

98592

98591



98592

98591 CASTRALVO

pendant light; steel, wood, satin nickel, brown / fabric, white
 Hängeleuchte; Stahl, Holz, nickel-matt, braun / Textil, weiss
 luminaire en suspension; acier, bois, nickel mat, marron / tissu, blanc

L 1210, B 150, H 1100



E27 5x 28W



9 002759 985912

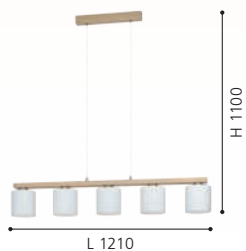

98592 CASTRALVO

pendant light; steel, wood, satin nickel, brown / glass vaporized, amber
 Hängeleuchte; Stahl, Holz, nickel-matt, braun / Glas bedampft, amber
 luminaire en suspension; acier, bois, nickel mat, marron / verre vaporisé, ambre

L 1210, B 150, H 1100



E27 5x 28W



9 002759 985929

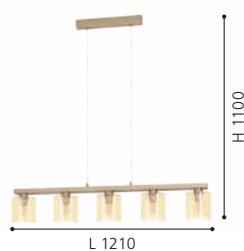

900313 CASTRALVO

pendant light; wood, steel, brown / fabric, black
 Hängeleuchte; Holz, Stahl, braun / Textil, schwarz
 luminaire en suspension; bois, acier, marron / tissu, noir

L 975, B 175, H 1100



E27 3x 40W



9 008606 235872

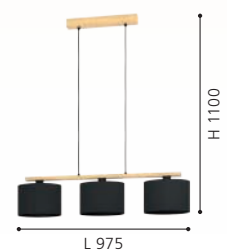

900313



CONTRISA

The luminaire is open at the top and has a beautiful play of light.

Die Leuchte ist nach oben offen und hat ein schönes Lichtspiel.

Le luminaire est ouvert en haut et a un beau jeu de lumière.

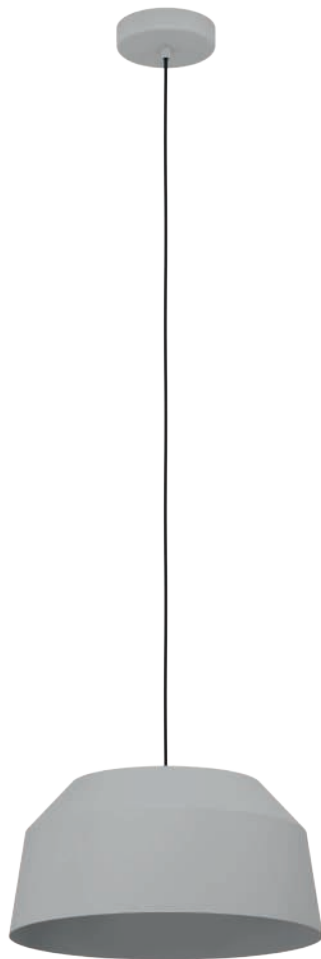

900379

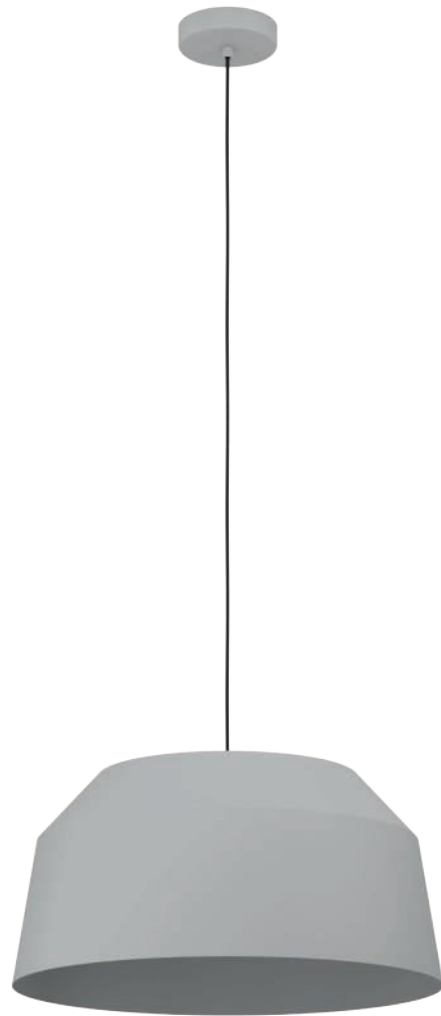

900381

900379 CONTRISA

pendant light; steel, grey
Hängeleuchte; Stahl, grau
luminaire en suspension; acier, gris

H 1100, Ø 380

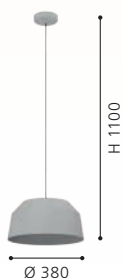

900381 CONTRISA

pendant light; steel, grey
Hängeleuchte; Stahl, grau
luminaire en suspension; acier, gris

H 1100, Ø 520



900362 MARIEL

pendant light; steel, wood, light grey, brown
Hängeleuchte; Stahl, Holz, hellgrau, braun
luminaire en suspension; acier, bois, gris clair, marron

L 910, B 190, H 1100

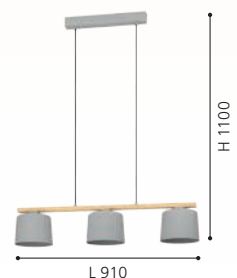



900362





95755



94935



94936

95755 NUVANO

pendant light; steel, brown, gold
Hängeleuchte; Stahl, braun, gold
luminaire en suspension; acier, marron, or

H 1100, Ø 480



E27 1x 60W



9 002759 957551



94935 GAETANO 1

pendant light; steel, black, gold
Hängeleuchte; Stahl, schwarz, gold
luminaire en suspension; acier, noir, or

H 1500, Ø 380



E27 1x 60W



9 002759 949358

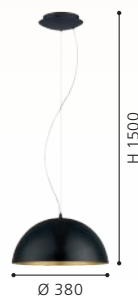

94936 GAETANO 1

pendant light; steel, black, gold
Hängeleuchte; Stahl, schwarz, gold
luminaire en suspension; acier, noir, or

H 1500, Ø 530



E27 1x 60W



9 002759 949365





99663

LED

99663 NUVANO

pendant light; steel, black, gold
 Hängeleuchte; Stahl, schwarz, gold
 luminaire en suspension; acier, noir, or

L 985, B 225, H 1100



GU10



3x 4,5 W



3x

345 lm

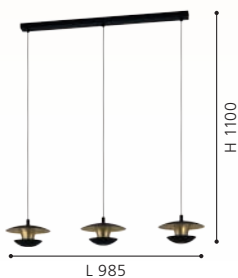



94938

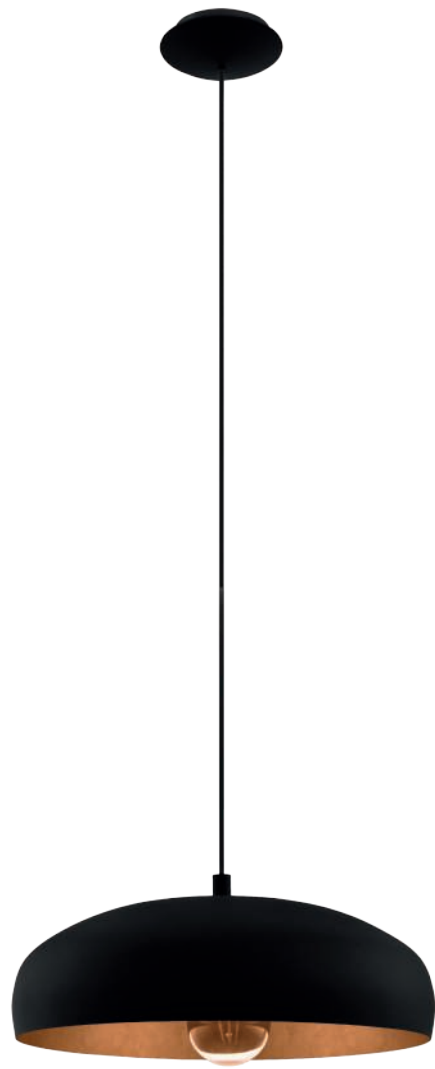

94605

94938 GAETANO 1

pendant light; steel, black, copper
 Hängeleuchte; Stahl, schwarz, kupfer
 luminaire en suspension; acier, noir, cuivre

H 1500, Ø 530

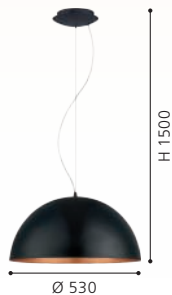

94605 MOGANO 1

pendant light; steel, black, copper
 Hängeleuchte; Stahl, schwarz, kupfer
 luminaire en suspension; acier, noir, cuivre

H 1100, Ø 400

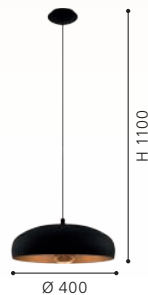
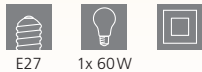

94606 MOGANO 1

pendant light; steel, white, copper
 Hängeleuchte; Stahl, weiss, kupfer
 luminaire en suspension; acier, blanc, cuivre

H 1100, Ø 400

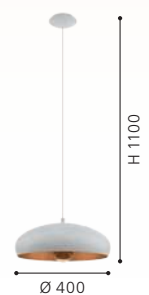



94606



98735

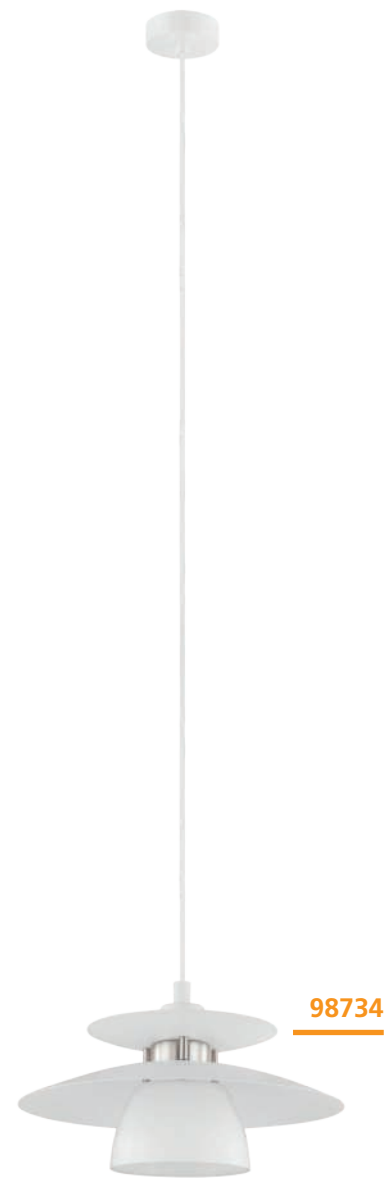

98734

98735 BRENDA

pendant light; steel, black, satin nickel
 Hängeleuchte; Stahl, schwarz, nickel-matt
 luminaire en suspension; acier, noir, nickel mat

H 1500, Ø 320



9 002759 987350



98734 BRENDA

pendant light; steel, white, satin nickel
 Hängeleuchte; Stahl, weiss, nickel-matt
 luminaire en suspension; acier, blanc, nickel mat

H 1500, Ø 320



9 002759 987343





87055



31666

87055 BRENDA

pendant light; plastic, steel, white, chrome / steel, white
 Hängeleuchte; Kunststoff, Stahl, weiss, chrom / Stahl, weiss
 luminaire en suspension; plastique, acier, blanc, chrome / acier, blanc

H 1300, Ø 430



E27 1x 60W



9 002759 870553

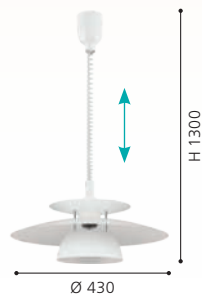

31666 BRENDA

pendant light; plastic, steel, black / steel, black, copper
 Hängeleuchte; Kunststoff, Stahl, schwarz / Stahl, schwarz, kupfer
 luminaire en suspension; plastique, acier, noir / acier, noir, cuivre

H 1100, Ø 430

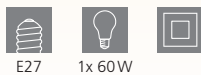

E27 1x 60W



9 002759 316662

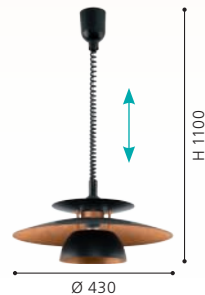

31666, 87055

This luminaires are flexible in height thanks to the spiral cables.

Diese Leuchten sind durch die Spiralkabel in der Höhe verstellbar.

La hauteur de ces lumières peut être ajustée à l'aide du câble en spirale.





87054

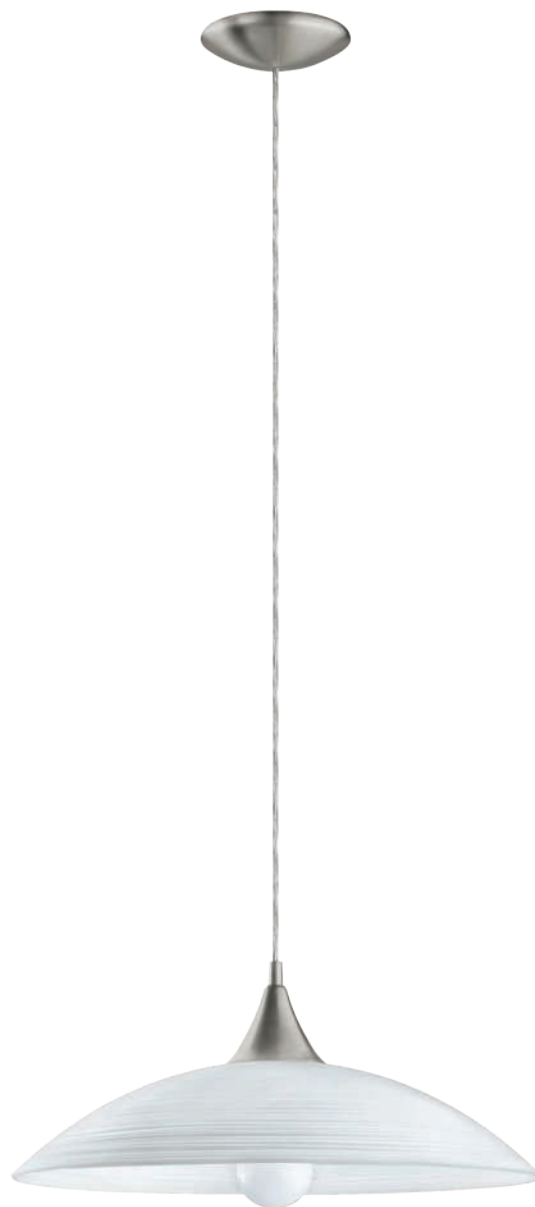

91496

87054 BRENDA

pendant light; steel, satin nickel / glass alabaster, white
 Hängeleuchte; Stahl, nickel-matt / Glas alabaster, weiss
 luminaire en suspension; acier, nickel mat / verre albâtre, blanc

H 1100, Ø 195



9 002759 870546



91496 LAZOLO

pendant light; steel, satin nickel / satin glass, white painted
 Hängeleuchte; Stahl, nickel-matt / Glas satiniert, weiss lackiert
 luminaire en suspension; acier, nickel mat / verre satiné, blanc laqué

H 1100, Ø 420



9 002759 914967

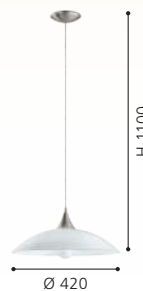

93468 MONTEFIO

pendant light; stainless steel, satin nickel / glass alabaster, white
 Hängeleuchte; Edelstahl, nickel-matt / Glas alabaster, weiss
 luminaire en suspension; acier inoxydable, nickel mat / verre albâtre, blanc

L 885, B 175, H 880 - 1300



9 002759 934682

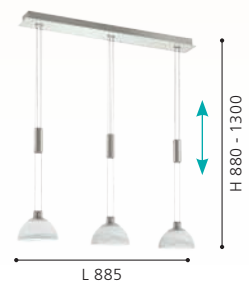



93468

LED



87008 LORD 2

pendant light; plastic, steel, silver, satin nickel / glass alabaster, white

Hängeleuchte; Kunststoff, Stahl, silber, nickel-matt / Glas alabaster, weiss

luminaire en suspension; plastique, acier, argent, nickel mat / verre albâtre, blanc

H 1100, Ø 360



87009 LORD 2

pendant light; plastic, wood, silver, satin nickel, beech / glass alabaster, white

Hängeleuchte; Kunststoff, Holz, silber, nickel-matt, Buche / Glas alabaster, weiss

luminaire en suspension; plastique, bois, argent, nickel mat, hêtre / verre albâtre, blanc

H 1100, Ø 360



3355, 87008, 87009



These luminaires are flexible in height thanks to the spiral cables.

Diese Leuchten sind durch die Spiralkabel in der Höhe verstellbar.

La hauteur de ces lumières peut être ajustée à l'aide du câble en spirale.



9 002759 870089

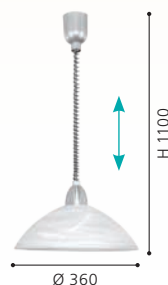

9 002759 870096

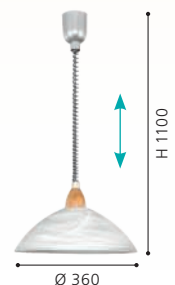



3355



90978



3355 ALESSANDRA

pendant light; plastic, white / glass alabaster, white
 Hängeleuchte; Kunststoff, weiss / Glas alabaster, weiss
 luminaire en suspension; plastique, blanc / verre albâtre, blanc

H 1100, Ø 380



E27 1x 60W



9 002759 335502

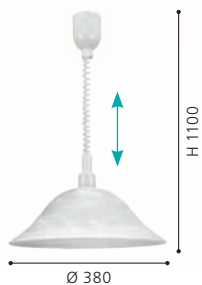

90978 ALBANY

pendant light; plastic, white / glass alabaster, white
 Hängeleuchte; Kunststoff, weiss / Glas alabaster, weiss
 luminaire en suspension; plastique, blanc / verre albâtre, blanc

H 1100, Ø 350



E27 1x 60W



9 002759 909789



3355, 87008, 87009, 90978

These luminaires come with high quality processed alabaster glass.

Diese Leuchten sind mit hochwertigem Alabasterglas ausgestattet.

Ces luminaires viennent avec un abat-jour en verre d'albâtre haut de gamme.



3041 VETRO

pendant light; plastic, white / satin glass, white, purple, black
 Hängeleuchte; Kunststoff, weiss / Glas satiniert, weiss, lila, schwarz
 luminaire en suspension; plastique, blanc / verre satiné, blanc, violet, noir

H 1100, Ø 420

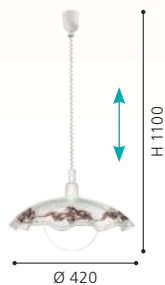

82786 VETRO

pendant light; plastic, white / glass, white, brown
 Hängeleuchte; Kunststoff, weiss / Glas, weiss, braun
 luminaire en suspension; plastique, blanc / verre, blanc, marron

H 1100, Ø 350

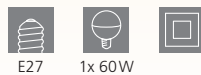

82785 VETRO

pendant light; plastic, white / satin glass, white
 Hängeleuchte; Kunststoff, weiss / Glas satiniert, weiss
 luminaire en suspension; plastique, blanc / verre satiné, blanc

H 1100, Ø 350

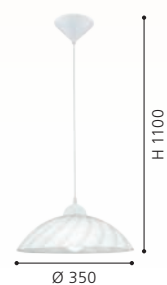



96474



96073



96072

3041, 96072, 96474

These luminaires are flexible in height thanks to the spiral cables.

Diese Leuchten sind durch die Spiralkabel in der Höhe verstellbar.

La hauteur de ces lumières peut être ajustée à l'aide du câble en spirale.



96474 ALVEZ

pendant light; plastic, white / glass with structure, white, clear
Hängeleuchte; Kunststoff, weiss / Glas mit Struktur, weiss, klar
luminaire en suspension; plastique, blanc / verre avec structure, blanc, transparent

H 1100, Ø 420



E27 1x 60W



9 002759 964740

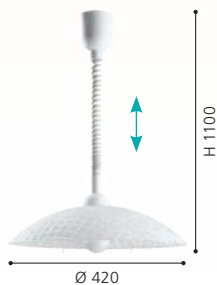

96073 VETRO

pendant light; plastic, white / satin glass, crystal, white, clear
Hängeleuchte; Kunststoff, weiss / Glas satiniert, Kristall, weiss, klar
luminaire en suspension; plastique, blanc / verre satiné, cristal, blanc, transparent

H 1100, Ø 350



E27 1x 60W



9 002759 960735



96072 VETRO

pendant light; plastic, white / satin glass, crystal, white, clear
Hängeleuchte; Kunststoff, weiss / Glas satiniert, Kristall, weiss, klar
luminaire en suspension; plastique, blanc / verre satiné, cristal, blanc, transparent

H 1100, Ø 415



E27 1x 60W



9 002759 960728

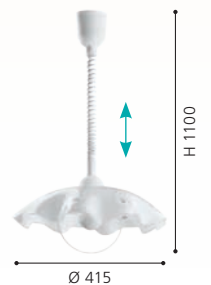

WALL & CEILING LUMINAIRES

WAND- & DECKENLEUCHTEN
APPLIQUES & PLAFONNIERS

OUR ALL-ROUNDERS

The range of wall and ceiling luminaires goes from simple to unusual designs. No matter if for the entrance area, hallway or your living rooms – these luminaires give the right light.

UNSERE ALLROUNDER

Das Sortiment an Wand- und Deckenleuchten reicht von schlichten bis hin zu ausgefallenen Designs. Egal ob für Eingangsbereich, Flur oder Ihre Wohnräume - diese Leuchten spenden das passende Licht.



NOS PASSE-PARTOUT

La gamme d'éclairages muraux et de plafonds s'étend de designs simples à extraordinaires. Que ce soit pour l'entrée, le couloir ou vos espaces d'habitat - ces luminaires apportent la lumière appropriée.



OVERVIEW

WALL & CEILING LUMINAIRES

 ALTAFLOR p. 456 - 458	 MONIROTE p. 457, 459	 RUOTALE p. 460	 ULISANO p. 460	 PADULARI p. 460	 ROLIMARE p. 461	 GAFARES p. 462 - 463	 IPOLITTO p. 464
 AMONTILLADO p. 464	 SPADAFORA p. 464	 ZAMPOTE p. 465	 TIRRENARA p. 466	 MARINELLO 1 p. 466	 MARINELLO p. 467	 MIRLAS p. 468	 TAMURIA p. 470
 BORDONARA p. 472	 MARMORATA p. 473	 BOCADELLA 1 p. 474	 MUSARA p. 475	 TREMEDAL p. 475	 MESSINARO p. 476	 BELSIANA p. 476	 ENCINITOS p. 477
 BELSIANA 1 p. 477	 MONTEBALDO p. 478	 BARRANCAS p. 478	 MORDAZO p. 479	 STAITI p. 479	 SILENTINA p. 480 - 481	 MACCHIONE p. 481	 PIEDRITAS p. 482
 MOGANO p. 484 - 485	 MOGANO 2 p. 487	 VALCASOTTO p. 488, 538	 VALCASOTTO 1 p. 489	 TARRAFO p. 489	 BASURTU p. 490	 LORETO p. 491	 LORETO 1 p. 491
 MARIEL p. 493	 FILAGO p. 493	 MAROJALES p. 493	 CABO p. 494	 CONDRADE 1 p. 494	 CLEMENTE p. 496	 ACOLLA 1 p. 497	 ACOLLA p. 497
 CARDITO p. 497	 FRADELO 1 p. 498 - 499	 FRADELO p. 500 - 502	 SORRENTA 1 p. 503	 VALLEMARE p. 503	 CANICOSA 2 p. 504	 MONTENOVO p. 505	 POZONDON p. 505

 GIRON p. 506	 GIRON-S p. 507	 FRANIA p. 508-509, 512-513	 FRANIA-S p. 510-511, 514-515	 ZAMUDILO p. 516	 SILERAS p. 516-517	 RUIDERA p. 517	 CAPASSO 1 p. 518
 VOLTAGO 2 p. 518	 LANCIANO p. 520-521	 LANCIANO 1 p. 520-521	 FERENTINO p. 522-523	 BATTISTONA p. 524	 BENARIBA p. 525	 COMPETA 1 p. 527-528	 PALERMO 2 p. 529
 CAPASSO p. 530	 RENDE p. 531	 NIEVES 1 p. 532	 NIEVES p. 533	 PESCAITO p. 534	 MUSURITA p. 534-535	 LAURITO p. 536	 SELUCI p. 536-537
 LUPPINERIA p. 539	 PENJAMO p. 540	 CALAGRANO p. 541	 MENTALURGIA p. 542	 REDUCTA 2 p. 543	 ELLA p. 544	 DURELO p. 545	 PLANET p. 546
 PLANET 1 p. 546-549	 MARGITTA 1 p. 551, 554	 MARS 1 p. 552-553	 MARS p. 553, 558	 SCALEA 1 p. 554	 RAYA p. 554	 GRAFIK p. 556	 NEMO p. 556
 SALOME p. 558-559	 MESTRE p. 560-561	 IMPERIAL p. 560	 ALMERA p. 561	 PASCAL 1 p. 561	 CAMPANIA p. 562	 GERBERA 1 p. 562	 COLTI p. 562
 SAN PERI p. 564	 STAITI 1 p. 564	 TAZZOLI p. 567	 CIGLIE p. 567	 CARTIGNANO p. 568	 CIVITATE p. 569	 TIMPAROSSA p. 570	 GURARE p. 571

 This product is available in different colors and shapes./ Dieser Artikel ist in unterschiedlichen Farben und Formen verfügbar.
Cet article est disponible en différentes couleurs et formes.

OVERVIEW

WALL & CEILING LUMINAIRES

							
ZINACUA p.571	ZUBIALDE p.572-573	ONO 2 p.573	MACCACARI p.574	FELONICHE p.575	SANIA 4 p.576-577	PASSA p.578-581	GASCUERIA p.582
							
ELIZONDO p.582	FALICETTO p.582	HAYES p.583	TANURA p.584	GUANAL p.584	MONGODIO 1 p.586	ELGVERO p.587	CADEGAL p.588-589
							
REMIDOS p.589	METRASS p.590	METRASS 2 p.591	METRASS 1 p.593	SARGINTO p.594-595			



This product is available in different colors and shapes./ Dieser Artikel ist in unterschiedlichen Farben und Formen verfügbar.
Cet article est disponible en différentes couleurs et formes.



FUNCTIONAL OVERVIEW

FUNKTIONSÜBERSICHT

PRÉSENTATION FONCTIONNELLE

The listed boxes inform you about the respective functions of our wall and ceiling luminaires. You will find them on the catalogue pages next to the product illustrations. The coloured symbol area indicates the special characteristics of the respective luminaire/luminaire family, e.g. dimming function. In the grey area below you will find detailed information on this function, e.g. dimmable from 10% - 100%.

For luminaires that come with a remote control, you can control the respective functions with the remote control. For luminaires without remote control, the functions can be switched directly on the wall switch.

Die angeführten Boxen informieren Sie über die jeweiligen Funktionen unserer Wand- und Deckenleuchten. Sie finden sie auf den Katalogseiten jeweils neben den Produktabbildungen. Der farbige Symbolbereich weist darauf hin, welche besonderen Eigenschaften die jeweilige Leuchte/Leuchtenfamilie bietet, z.B. Dimmfunktion. Im grauen Bereich darunter finden Sie detaillierte Angaben zu dieser Funktion, z.B. dimmbar von 10% - 100%.

Ist eine Fernbedienung im Lieferumfang enthalten, können Sie die jeweiligen Funktionen mit der Fernbedienung steuern. Bei Leuchten ohne Fernbedienung können die Funktionen direkt am Wandschalter geschaltet werden.

Les boîtes de dialogue présentes vous informent sur les fonctions respectives de nos appliques et plafonniers. Vous les trouverez sur les pages du catalogue à côté des illustrations des produits. La zone colorée des symboles indique les caractéristiques particulières de chaque luminaire/famille de luminaires, par ex. la fonction de gradation. Dans la zone grise ci-dessous, vous trouverez des informations détaillées sur cette fonction, par ex. graduable de 10% - 100%.

Pour les luminaires équipés d'une télécommande, vous pouvez commander les fonctions correspondantes à l'aide de la télécommande. Pour les luminaires sans télécommande, les fonctions peuvent être commutées directement sur l'interrupteur mural.



DIMMABLE

e.g./z.B./par ex.
10 - 100%

The brightness of the luminaire can be steplessly controlled.

Die Helligkeit der Leuchte kann stufenlos im angegebenen Bereich gesteuert werden.

La luminosité du luminaire peut être réglée en continu.



STEP DIMMING

e.g./z.B./par ex.
10%/50%/100%

The brightness of the luminaire can be controlled step by step.

Die Helligkeit der Leuchte kann schrittweise gesteuert werden.

La luminosité du luminaire peut être réglée pas à pas.



TUNABLE WHITE

e.g./z.B./par ex.
2700 - 6500 K

The colour temperature can be controlled from warm to cold white LED light.

Die Farbtemperatur kann von warm- bis kaltweißem LED-Licht gesteuert werden.

La température de couleur peut être réglée de la lumière DEL blanche chaude à la lumière DEL blanche froide.



STEP TUNABLE

e.g./z.B./par ex.
3000/4000/5000 K

The colour temperature of warm to cold white LED light can be changed directly on the wall switch in 3 preset steps.

Die Farbtemperatur von warm- bis kaltweißem LED-Licht kann direkt am Wandschalter in 3 voreingestellten Schritten verändert werden.

La température de couleur peut être modifiée de la lumière DEL blanche chaude à la lumière DEL blanche froide directement sur l'interrupteur mural en 3 étapes prédéfinies.



NIGHT LIGHT FUNCTION

Luminaires can be switched to a night light mode. With included remote control or, for luminaires without remote control, via wall switch (ambient light).

Leuchten können auf einen Nacht-Licht-Modus umgeschaltet werden. Mit inkludierter Fernbedienung oder bei Leuchten ohne Fernbedienung per Wandschalter (Ambient light).

Les luminaires peuvent être commutés en mode veilleuse. Avec télécommande incluse ou, pour les luminaires sans télécommande, via interrupteur mural (lumière ambiante).



TIMER FUNCTION

e.g./z.B./par ex.
off after 30 sec.

The luminaire switches itself off after a preset time.

Die Leuchte schaltet sich nach einer voreingestellten Zeit selbst aus.

La lumière s'éteint d'elle-même après une durée prédéfinie.





99788

LED

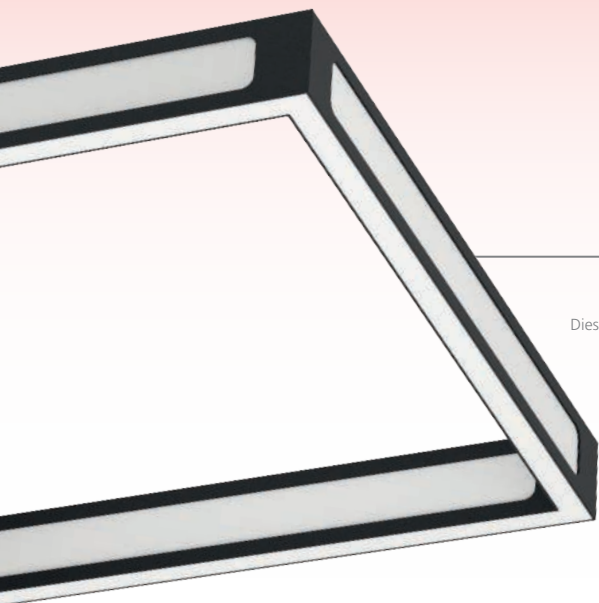

ALTAFLOR

These luminaires have an additional glow on the inside.

Diese Leuchten haben einen zusätzlichen Lichtschein nach Innen.

Ces luminaires ont une lueur supplémentaire à l'intérieur.

99788 ALTAFLOR

ceiling light; steel, black / plastic, white
Deckenleuchte; Stahl, schwarz / Kunststoff, weiss
plafonnier; acier, noir / plastique, blanc

L 650, B 300, H 70

LED

warm
WHITE



8x 2,8W 3040lm



9 002759 997885

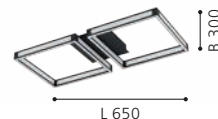

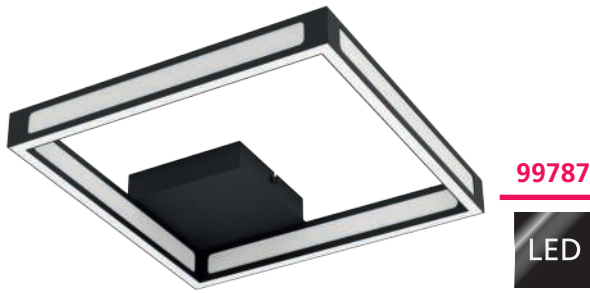

99787



99789

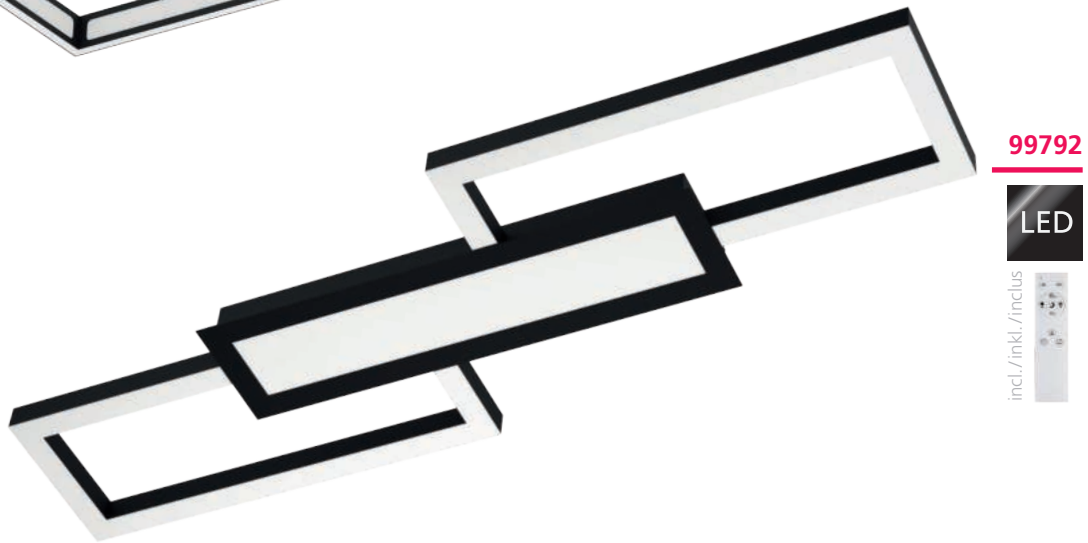

99792



incl./inkl./inclus

99787 ALTAFLOR

ceiling light; steel, black / plastic, white
Deckenleuchte; Stahl, schwarz / Kunststoff, weiss
plafonnier; acier, noir / plastique, blanc

L 315, B 315, H 70



4x 2,8W 1520lm

99789 ALTAFLOR

ceiling light; steel, black / plastic, white
Deckenleuchte; Stahl, schwarz / Kunststoff, weiss
plafonnier; acier, noir / plastique, blanc

L 1000, B 315, H 70



12x 2,8W 4560lm

99792 MONIROTE

ceiling light; steel, aluminium, black / plastic, white
Deckenleuchte; Stahl, Alu, schwarz / Kunststoff, weiss
plafonnier; acier, aluminium, noir / plastique, blanc

L 780, H 45



37W 4450lm Remote



9 002759 997878

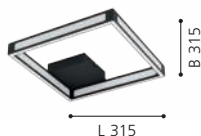

9 002759 997892

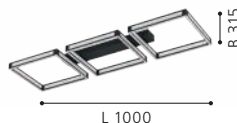

9 002759 997922

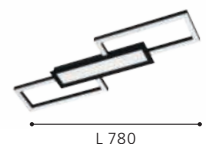



99784

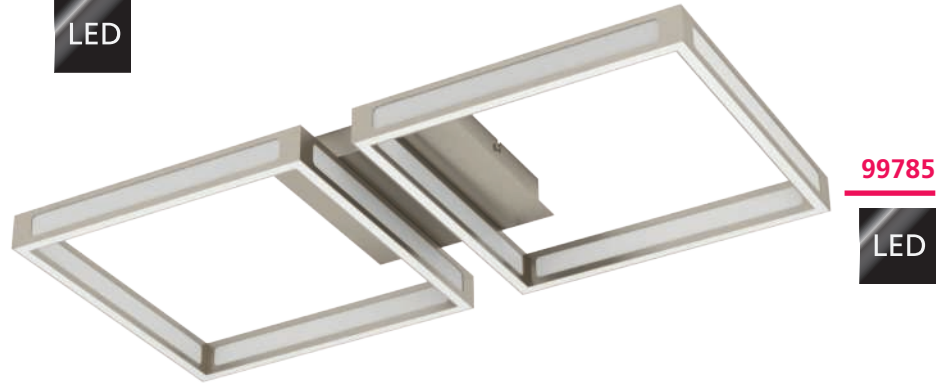

99785

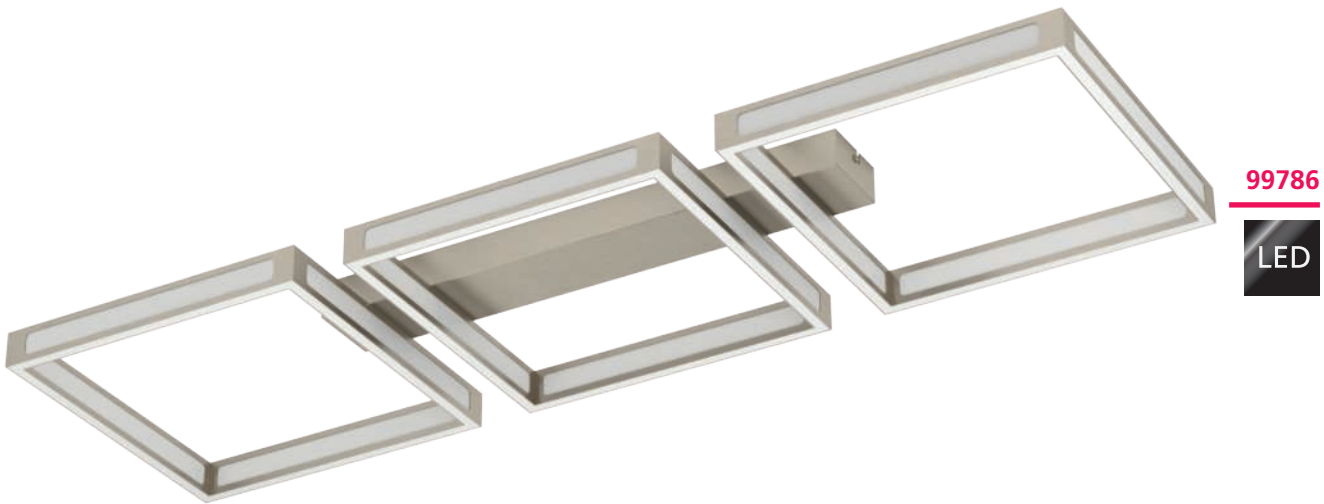

99786



99784 ALTAFLOR

ceiling light; steel, satin nickel / plastic, white
Deckenleuchte; Stahl, nickel-matt / Kunststoff, weiss
plafonnier; acier, nickel mat / plastique, blanc

L 315, B 315, H 70



4x 2,8W 1520lm

99785 ALTAFLOR

ceiling light; steel, satin nickel / plastic, white
Deckenleuchte; Stahl, nickel-matt / Kunststoff, weiss
plafonnier; acier, nickel mat / plastique, blanc

L 650, B 300, H 70



8x 2,8W 3040lm

99786 ALTAFLOR

ceiling light; steel, satin nickel / plastic, white
Deckenleuchte; Stahl, nickel-matt / Kunststoff, weiss
plafonnier; acier, nickel mat / plastique, blanc

L 1000, B 315, H 70



12x 2,8W 4560lm



9 002759 997847

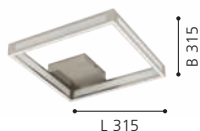

9 002759 997854

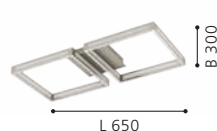

9 002759 997861

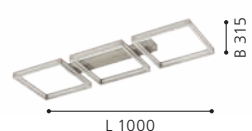



99791

LED

incl./inkl./inclus



99791 MONIROTE

ceiling light; steel, aluminium, satin nickel / plastic, white
 Deckenleuchte; Stahl, Alu, nickel-matt / Kunststoff, weiss
 plafonnier; acier, aluminium, nickel mat / plastique, blanc

L 780, B 260, H 45



37W

4450lm

Remote

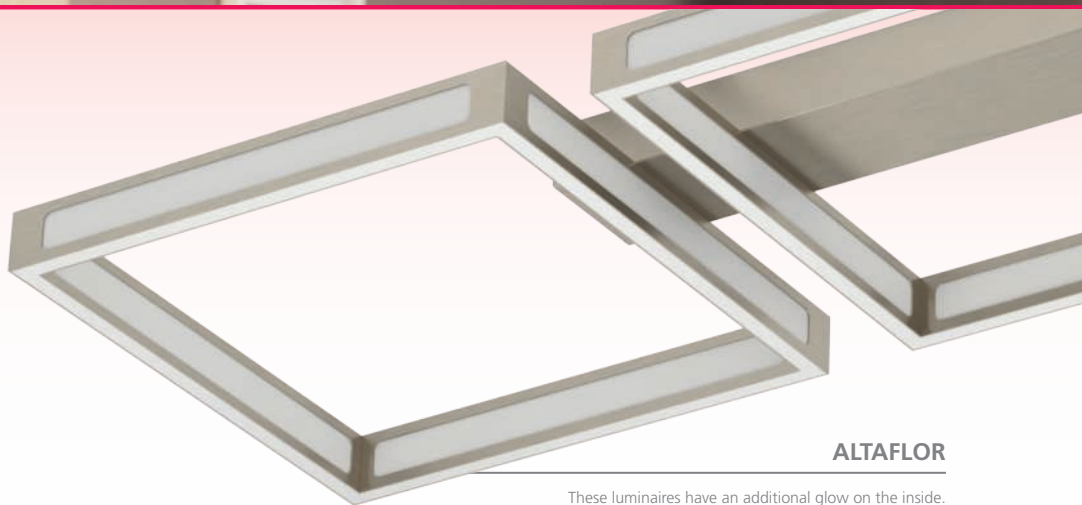
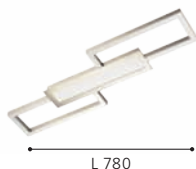

ALTAFLOR

These luminaires have an additional glow on the inside.
 Diese Leuchten haben einen zusätzlichen Lichtschein nach Innen.
 Ces luminaires ont une lueur supplémentaire à l'intérieur.



900471

LED



900596

LED

incl./inkl./inclus

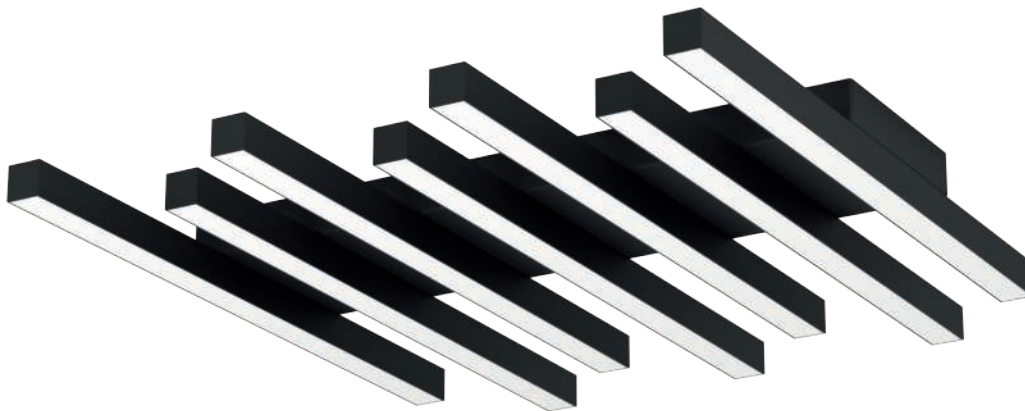

900597

LED

incl./inkl./inclus



900471 RUOTALE

ceiling light; aluminium, steel, black / plastic, white
Deckenleuchte; Alu, Stahl, schwarz / Kunststoff, weiss
plafonnier; aluminium, acier, noir / plastique, blanc

H 55, Ø 450



36W



4400lm



900596 ULISANO

ceiling light; aluminium, steel, black / plastic, white
Deckenleuchte; Alu, Stahl, schwarz / Kunststoff, weiss
plafonnier; aluminium, acier, noir / plastique, blanc

L 420, B 420, H 55



21W



3000lm



900597 PADULARI

ceiling light; aluminium, steel, black / plastic, white
Deckenleuchte; Alu, Stahl, schwarz / Kunststoff, weiss
plafonnier; aluminium, acier, noir / plastique, blanc

L 535, B 470, H 50



25,6W



3800lm



Remote



9 008606 244096



9 008606 244959



9 008606 244966





900419

LED



99395

LED



900419 ROLIMARE

ceiling light; aluminium, satin nickel / plastic, white
Deckenleuchte; Alu, nickel-matt / Kunststoff, weiss
plafonnier; aluminium, nickel mat / plastique, blanc

L 420, B 400, H 130

LED

35W

neutral
WHITE

5500lm



99395 ROLIMARE

ceiling light; aluminium, black / plastic, white
Deckenleuchte; Alu, schwarz / Kunststoff, weiss
plafonnier; aluminium, noir / plastique, blanc

L 420, B 400, H 130

LED

35W

neutral
WHITE

5500lm



9 008606 240999



L 420

H 130



9 002759 993955



L 420

H 130

DESIGN
HIGHLIGHT
DETAIL



900421

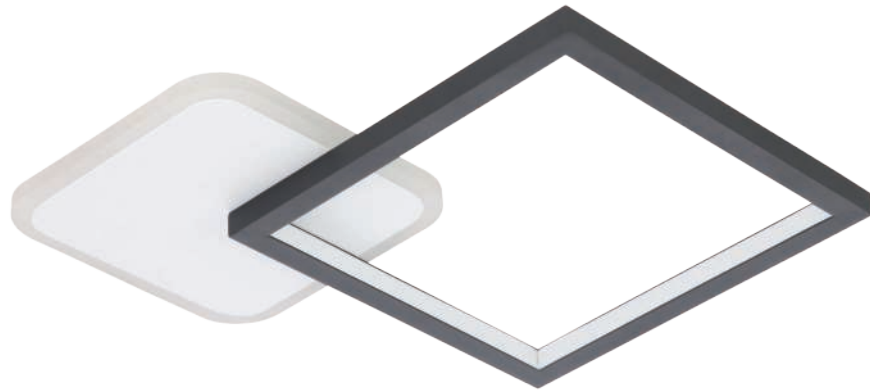

900422

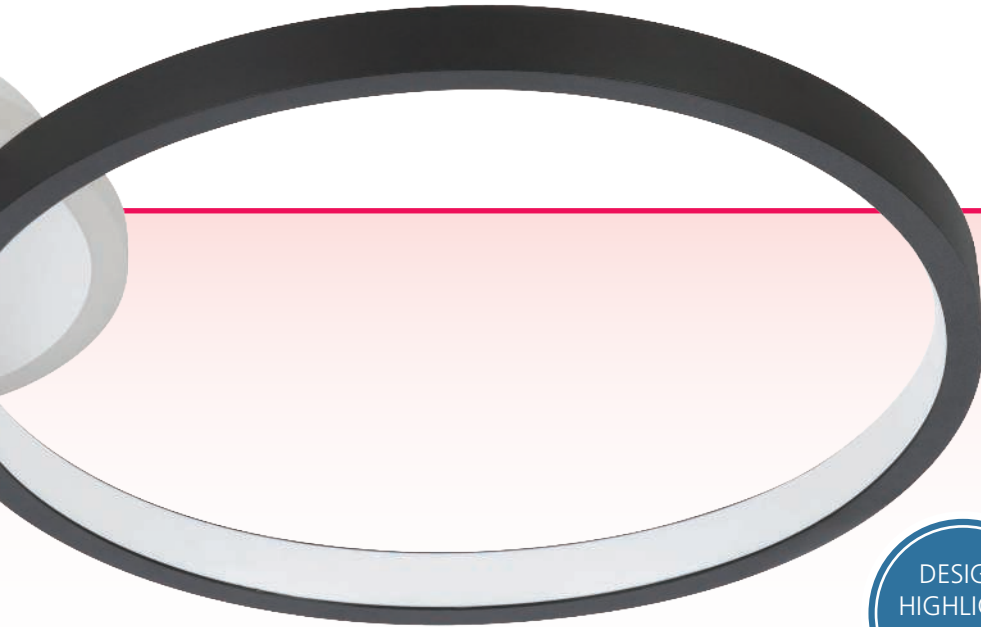

900421 GAFARES

ceiling light; aluminium, steel, black, white / plastic, white
Deckenleuchte; Alu, Stahl, schwarz, weiss / Kunststoff, weiss
plafonnier; aluminium, acier, noir, blanc / plastique, blanc

L 405, B 290, H 55



15W



2100lm



Remote



DESIGN
HIGHLIGHT
DETAIL



9 008606 241002





900423

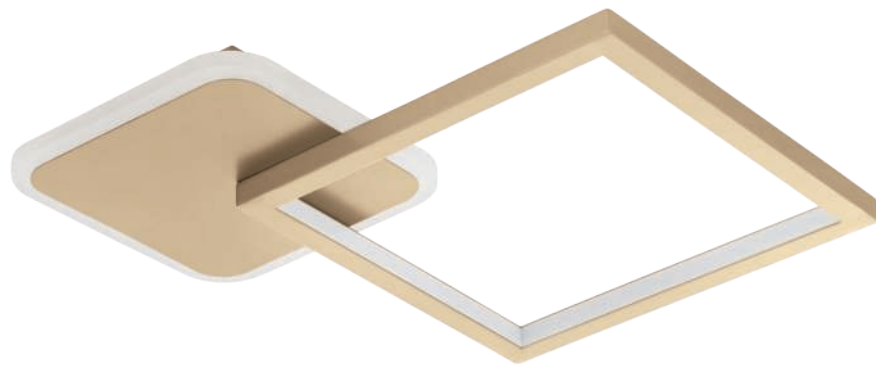

900424



900422 GAFARES

ceiling light; aluminium, steel, black, white / plastic, white
Deckenleuchte; Alu, Stahl, schwarz, weiss / Kunststoff, weiss
plafonnier; aluminium, acier, noir, blanc / plastique, blanc

L 330, B 330, H 50



15W 2100lm



9 008606 241026

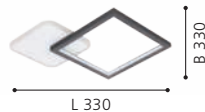

900423 GAFARES

ceiling light; aluminium, steel, gold, white / plastic, white
Deckenleuchte; Alu, Stahl, gold, weiss / Kunststoff, weiss
plafonnier; aluminium, acier, or, blanc / plastique, blanc

L 405, B 290, H 55



15W 2100lm



9 008606 241019



900424 GAFARES

ceiling light; aluminium, steel, gold, white / plastic, white
Deckenleuchte; Alu, Stahl, gold, weiss / Kunststoff, weiss
plafonnier; aluminium, acier, or, blanc / plastique, blanc

L 330, B 330, H 50



15W 2100lm



9 008606 241033

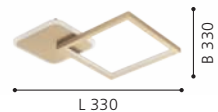



99817

LED



98491

LED



98494

LED

99817 IPOLITTO

ceiling light; aluminium, steel, black / plastic, white
Deckenleuchte; Alu, Stahl, schwarz / Kunststoff, weiss
plafonnier; aluminium, acier, noir / plastique, blanc

L 995, B 165, H 245



4x 7,5W 3600lm

98491 AMONTILLADO

ceiling light; aluminium, steel, black / plastic, white
Deckenleuchte; Alu, Stahl, schwarz / Kunststoff, weiss
plafonnier; aluminium, acier, noir / plastique, blanc

L 1125, B 8



2x 13,5W 3500lm

98494 SPADAFORA

ceiling light; aluminium, steel, black / plastic, clear, white
Deckenleuchte; Alu, Stahl, schwarz / Kunststoff, klar, weiss
plafonnier; aluminium, acier, noir / plastique, transparent, blanc

L 1160, B 80, H 100



21,5W 2500lm



9 002759 998172

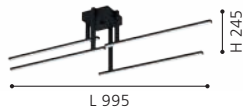

L 995



9 002759 984915



L 1125



9 002759 984946



L 1160



900328

LED



900329

LED



900328 ZAMPOTE

ceiling light; aluminium, steel, white, black / plastic, white
Deckenleuchte; Alu, Stahl, weiss, schwarz / Kunststoff, weiss
plafonnier; aluminium, acier, blanc, noir / plastique, blanc

H 50, Ø 420



25W 3400lm

900329 ZAMPOTE

ceiling light; aluminium, steel, white, black / plastic, white
Deckenleuchte; Alu, Stahl, weiss, schwarz / Kunststoff, weiss
plafonnier; aluminium, acier, blanc, noir / plastique, blanc

L 380, B 380, H 50



25W 3300lm



9 008606 238095



9 008606 238101

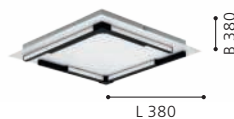



900603

LED



incl./inkl./inclus

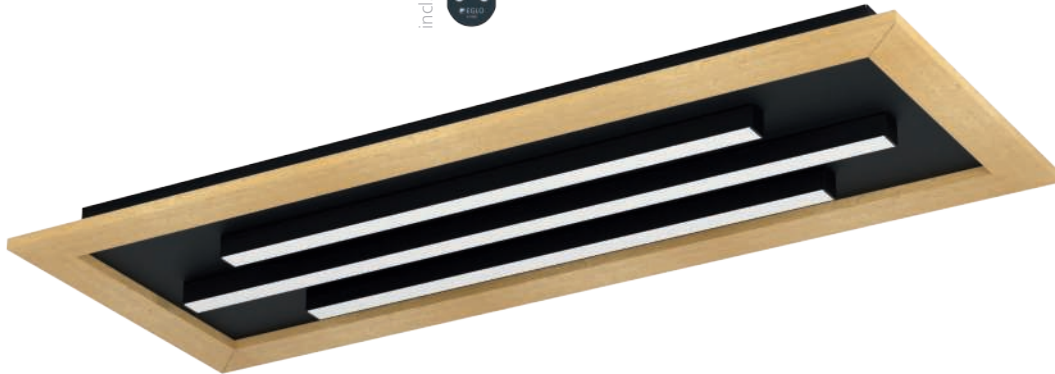

900604

LED



incl./inkl./inclus



99793

LED

900603 TIRRENARA

ceiling light; steel, wood, black, brown / plastic, white
Deckenleuchte; Stahl, Holz, schwarz, braun / Kunststoff, weiss
plafonnier; acier, bois, noir, marron / plastique, blanc

L 370, B 370, H 55



4x 5,4W 2600lm

Remote

900604 TIRRENARA

ceiling light; steel, wood, black, brown / plastic, white
Deckenleuchte; Stahl, Holz, schwarz, braun / Kunststoff, weiss
plafonnier; acier, bois, noir, marron / plastique, blanc

L 780, B 305, H 55



2x 9,2W 3960lm 1x 13,7W

Remote

99793 MARINELLO 1

ceiling light; aluminium, steel, wood, black, brown / plastic, white
Deckenleuchte; Alu, Stahl, Holz, schwarz, braun / Kunststoff, weiss
plafonnier; aluminium, acier, bois, noir, marron / plastique, blanc

L 500, B 500, H 90



4x 5,3W 2800lm



9 008606 245017

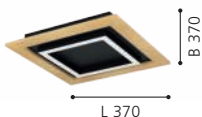

9 008606 245024



9 002759 997939

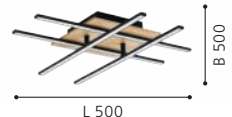



99659

LED

incl./inkl./inclus



99659 MARINELLO

ceiling light; aluminium, steel, wood, black, brown / plastic, white

Deckenleuchte; Alu, Stahl, Holz, schwarz, braun / Kunststoff, weiss

plafonnier; aluminium, acier, bois, noir, marron / plastique, blanc

L 485, B 485, H 55

LED

2x 17W

tunable
WHITE

3800lm

LED

4,2W

tunable
WHITE

550lm



Remote



9 002759 996598

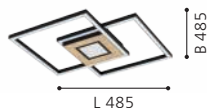



98861



MIRLAS



98862



98861 MIRLAS

ceiling light; wood, steel, brown / plastic, white
Deckenleuchte; Holz, Stahl, braun / Kunststoff, weiss
plafonnier; bois, acier, marron / plastique, blanc

L 360, B 210, H 90



E27



2x 9W



9 002759 988616



98862 MIRLAS

ceiling light; wood, steel, brown / plastic, white
Deckenleuchte; Holz, Stahl, braun / Kunststoff, weiss
plafonnier; bois, acier, marron / plastique, blanc

L 690, B 270, H 90



E27



4x 9W



9 002759 988623

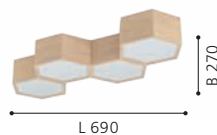

98863 MIRLAS

ceiling light; wood, steel, brown / plastic, white
Deckenleuchte; Holz, Stahl, braun / Kunststoff, weiss
plafonnier; bois, acier, marron / plastique, blanc

L 540, B 520, H 90



E27



6x 9W



9 002759 988630

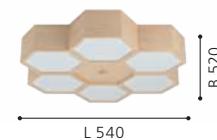



98863



99656

LED

TUMARIA

This luminaires have rotatable panels in wood look and black.

Diese Artikel verfügen über Platten in Holzoptik und schwarz zum Wechseln.

Ces luminaires a des panneaux en bois optique et noir à changer.

99656 TAMURIA

ceiling light; steel, wood, black, brown / plastic, white
Deckenleuchte; Stahl, Holz, schwarz, braun / Kunststoff, weiss
plafonnier; acier, bois, noir, marron / plastique, blanc

L 435, B 435, H 70



21W 2700lm

99655 TAMURIA

ceiling light; steel, wood, black, brown / plastic, white
Deckenleuchte; Stahl, Holz, schwarz, braun / Kunststoff, weiss
plafonnier; acier, bois, noir, marron / plastique, blanc

L 285, B 285, H 60



10,8W 1300lm





99655

LED



900571

LED

incl./inkl./inclus



900572

LED

incl./inkl./inclus



900573

LED

incl./inkl./inclus



900571 BORDONARA

ceiling light; aluminium, steel, black, white / plastic, white
Deckenleuchte; Alu, Stahl, schwarz, weiss / Kunststoff, weiss
plafonnier; aluminium, acier, noir, blanc / plastique, blanc

L 450, B 450

LED

21,5W

RGB+TW

2800lm



900572 BORDONARA

ceiling light; aluminium, steel, black, white / plastic, white
Deckenleuchte; Alu, Stahl, schwarz, weiss / Kunststoff, weiss
plafonnier; aluminium, acier, noir, blanc / plastique, blanc

L 595, B 595

LED

36W

RGB+TW

4900lm



900573 BORDONARA

ceiling light; aluminium, steel, black, white / plastic, white
Deckenleuchte; Alu, Stahl, schwarz, weiss / Kunststoff, weiss
plafonnier; aluminium, acier, noir, blanc / plastique, blanc

L 1195, B 295

LED

35W

RGB+TW

5400lm



9 008606 244720

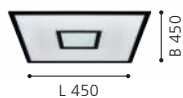

9 008606 244737



9 008606 244744





900558



900559



900561



900558 MARMORATA

ceiling light; aluminium, steel, black, white / plastic, white
Deckenleuchte; Alu, Stahl, schwarz, weiss / Kunststoff, weiss
plafonnier; aluminium, acier, noir, blanc / plastique, blanc

H 70, Ø 450



18W 2300lm 9W 1100lm



9 008606 244614



900559 MARMORATA

ceiling light; aluminium, steel, black, white / plastic, white
Deckenleuchte; Alu, Stahl, schwarz, weiss / Kunststoff, weiss
plafonnier; aluminium, acier, noir, blanc / plastique, blanc

L 445, B 445



19W 2400lm 9W 1200lm



9 008606 244621



900561 MARMORATA

ceiling light; aluminium, steel, black, white / plastic, white
Deckenleuchte; Alu, Stahl, schwarz, weiss / Kunststoff, weiss
plafonnier; aluminium, acier, noir, blanc / plastique, blanc

L 595, B 295



17W 2400lm 9W 1100lm



9 008606 244638





98319



98317



98318

98319 BOCADELLA 1

ceiling light; steel, black
Deckenleuchte; Stahl, schwarz
plafonnier; acier, noir

H 360, Ø 920



E27

12x 60W

98317 BOCADELLA 1

ceiling light; steel, black
Deckenleuchte; Stahl, schwarz
plafonnier; acier, noir

H 215, Ø 345



E27

3x 60W

98318 BOCADELLA 1

ceiling light; steel, black
Deckenleuchte; Stahl, schwarz
plafonnier; acier, noir

H 365, Ø 640



E27

9x 60W



9 002759 983192

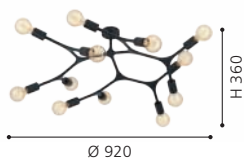

9 002759 983178

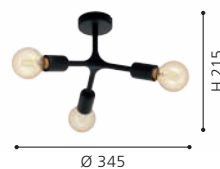

9 002759 983185

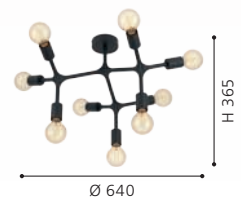



98679



98507

98679 MUSARA

ceiling light; steel, black
Deckenleuchte; Stahl, schwarz
plafonnier; acier, noir

H 850, Ø 790

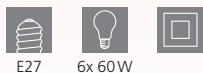

E27 6x 60W



9 002759 986797

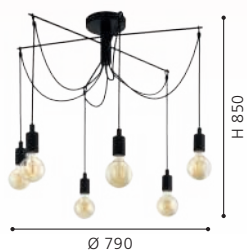

98507 TREMEDAL

ceiling light; steel, black
Deckenleuchte; Stahl, schwarz
plafonnier; acier, noir

H 215, Ø 560



E27 1x 28W



9 002759 985073

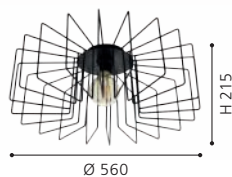



900367



98034



98035

900367 MESSINARO

ceiling light; steel, black, brushed brass
Deckenleuchte; Stahl, schwarz, messing-gebürstet
plafonnier; acier, noir, laiton brossé

L 720, B 280, H 115



E27

3x 40W

98034 BELSIANA

ceiling light; steel, black
Deckenleuchte; Stahl, schwarz
plafonnier; acier, noir

L 890, B 510, H 350



E27

6x 40W

98035 BELSIANA

ceiling light; steel, black
Deckenleuchte; Stahl, schwarz
plafonnier; acier, noir

L 1180, B 510, H 350



E27

8x 40W



9 008606 243525

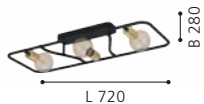

9 002759 980344

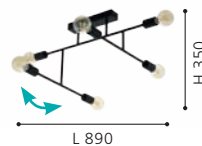

9 002759 980351

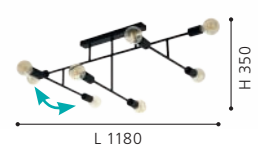



99664

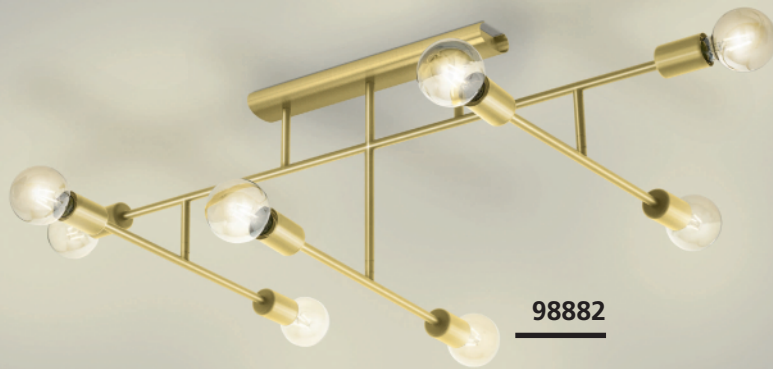

98882

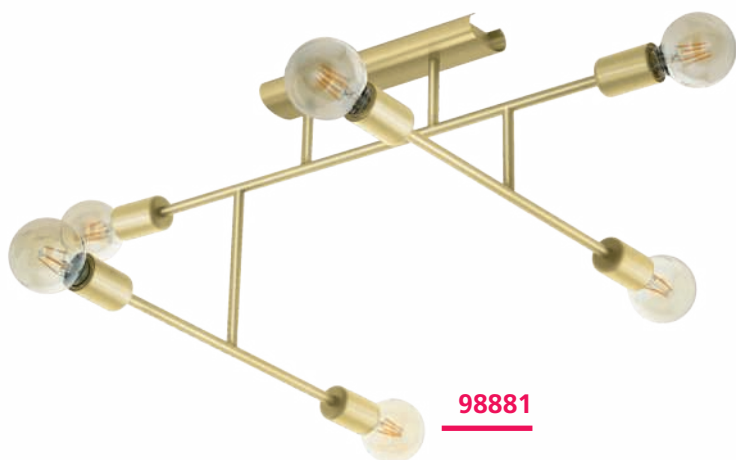

98881



99664 ENCINITOS

ceiling light; steel, black, gold
Deckenleuchte; Stahl, schwarz, gold
plafonnier; acier, noir, or

H 260, Ø 450



E27 1x 40W

98881 BELSIANA 1

ceiling light; steel, brushed brass
Deckenleuchte; Stahl, messing-gebürstet
plafonnier; acier, laiton brossé

L 1155, B 495, H 455



E27 6x 40W

98882 BELSIANA 1

ceiling light; steel, brushed brass
Deckenleuchte; Stahl, messing-gebürstet
plafonnier; acier, laiton brossé

L 1180, B 380, H 350



E27 8x 40W



9 002759 996642

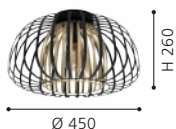

9 002759 988814

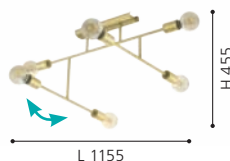

9 002759 988821

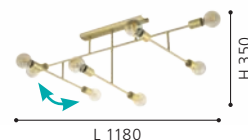



97731

LED



900302



97731 MONTEBALDO

ceiling light; steel, black, gold
Deckenleuchte; Stahl, schwarz, gold
plafonnier; acier, noir, or

L 380, B 380, H 170



GU10



4x 4,5W



warm
WHITE

4x

345lm

900302 BARRANCAS

ceiling light; steel, black, gold / crystal, clear
Deckenleuchte; Stahl, schwarz, gold / Kristall, klar
plafonnier; acier, noir, or / cristal, transparent

L 380, B 380, H 180



E14



4x 40W



9 002759 977313



INCL.

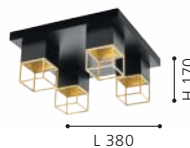

9 008606 242764





900524



97904



97895

900524 MORDAZO

ceiling light; steel, black / fabric, wood, anthracite-brown, white
 Deckenleuchte; Stahl, schwarz / Textil, Holz, anthrazit-braun, weiss
 plafonnier; acier, noir / textile, bois, marron anthracite, blanc

L 510, B 510, H 175



E27 4x 28W

97904 STAITI

ceiling light; steel, black
 Deckenleuchte; Stahl, schwarz
 plafonnier; acier, noir

H 140, Ø 760



E27 7x 60W

97895 STAITI

ceiling light; steel, black / fabric, black, gold
 Deckenleuchte; Stahl, schwarz / Textil, schwarz, gold
 plafonnier; acier, noir / tissu, noir, or

H 235, Ø 840



E27 7x 40W



9 008606 244522

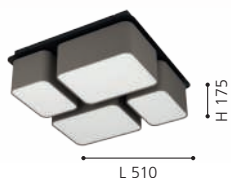

9 002759 979041

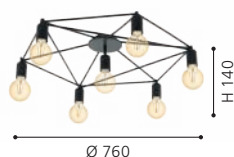

9 002759 978952





98333



98331



98332

98333 SILENTINA

ceiling light; steel, black
Deckenleuchte; Stahl, schwarz
plafonnier; acier, noir

L 540, B 180, H 205



E27



3x 40W

98331 SILENTINA

ceiling light; steel, black
Deckenleuchte; Stahl, schwarz
plafonnier; acier, noir

L 180, B 180, H 205



E27



1x 40W

98332 SILENTINA

ceiling light; steel, black
Deckenleuchte; Stahl, schwarz
plafonnier; acier, noir

L 360, B 180, H 205



E27



2x 40W



9 002759 983338

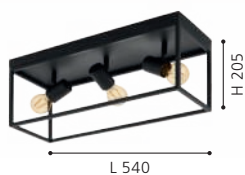

9 002759 983314

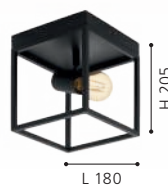

9 002759 983321





98334



900509

98334 SILENTINA

ceiling light; steel, black
Deckenleuchte; Stahl, schwarz
plafonnier; acier, noir

L 360, B 360, H 205



9 002759 983345

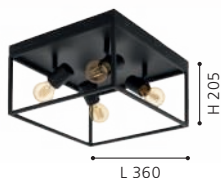

900509 MACCHIONE

wall light; steel, black, brass
Wandleuchte; Stahl, schwarz, messing
applique; acier, noir, laiton

L 500, H 110, A 85



9 008606 244393

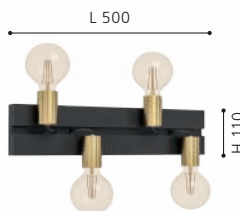

MACCHIONE

Frames can be individually aligned for the customer using a magnet. The luminaire works both as a wall luminaire and as a ceiling luminaire.

Fassungen sind mithilfe eines Magnets für den Kunden individuell ausrichtbar. Die Leuchte funktioniert sowohl als Wandleuchte, als auch als Deckenleuchte.

Les cadres peuvent être alignés individuellement pour le client à l'aide d'un aimant. La luminaire fonctionne à la fois comme applique murale et comme plafonnier.





900357



900356

900357 PIEDRITAS

ceiling light; steel, black
Deckenleuchte; Stahl, schwarz
plafonnier; acier, noir

L 730, B 180, H 205



E27 3x 40W

900356 PIEDRITAS

ceiling light; steel, black
Deckenleuchte; Stahl, schwarz
plafonnier; acier, noir

L 515, B 180, H 205



E27 2x 40W

900355 PIEDRITAS

ceiling light; steel, black
Deckenleuchte; Stahl, schwarz
plafonnier; acier, noir

L 180, B 180, H 205



E27 1x 40W



9 008606 235728

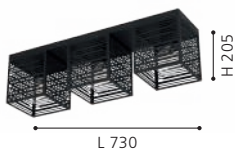

L 730



9 008606 235711



L 515



9 008606 235704

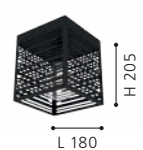

L 180



900355





94547



94548



900359

94547 MOGANO

ceiling light; steel, black, copper
Deckenleuchte; Stahl, schwarz, kupfer
plafonnier; acier, noir, cuivre

H 170, Ø 400



94548 MOGANO

ceiling light; steel, white, silver
Deckenleuchte; Stahl, weiss, silber
plafonnier; acier, blanc, argent

H 170, Ø 400



900359 MOGANO

ceiling light; steel, Mokka colour
Deckenleuchte; Stahl, Mokkafarben
plafonnier; acier, café

H 175, Ø 400



9 002759 945473

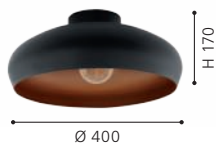

9 002759 945480



9 008606 235315

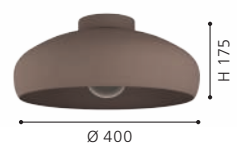



43637

43637 MOGANO

ceiling light; steel, black
Deckenleuchte; Stahl, schwarz
plafonnier; acier, noir

H 170, Ø 400



E27



1x 60W



9 002759 436377

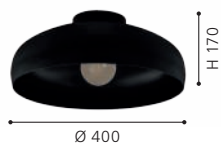



900553





900554



900555

900553 MOGANO 2

ceiling light; steel, black
Deckenleuchte; Stahl, schwarz
plafonnier; acier, noir

H 175, Ø 280



E27 1x 40W

900554 MOGANO 2

ceiling light; steel, black, gold
Deckenleuchte; Stahl, schwarz, gold
plafonnier; acier, noir, or

H 175, Ø 280



E27 1x 40W

900555 MOGANO 2

ceiling light; steel, black, copper
Deckenleuchte; Stahl, schwarz, kupfer
plafonnier; acier, noir, cuivre

H 175, Ø 280



E27 1x 40W



9 008606 244584



9 008606 244591

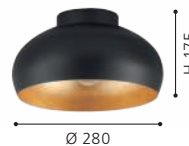

9 008606 244607

